

**Coverage Enhancement Through Two-hop Relaying  
in Cellular Radio Systems**

**Van Morning Sreng**

**OCIECE 01-02**

**Coverage Enhancement Through Two-hop Relaying  
in Cellular Radio Systems**

By

Van Morning Sreng, B.Eng.

A thesis submitted to

the Faculty of Graduate Studies and Research

in partial fulfillment of

the requirements of the degree of

**Master of Applied Science**

**Ottawa-Carleton Institute for Electrical and Computer Engineering**

**Department of Systems and Computer Engineering**

**Carleton University**

**Ottawa, Ontario**

Copyright 2002, Van Morning Sreng

The undersigned hereby recommended to the Faculty of Graduate Studies  
and Research acceptance of the thesis

**Coverage Enhancement Through Two-hop Relaying in Cellular  
Radio Systems**

Submitted by Van Morning Sreng

In partial fulfillment of the requirements for the  
Degree of Master of Applied Science

---

**Thesis Co-Supervisor  
Prof. David Falconer**

---

**Thesis Co-Supervisor  
Prof. Halim Yanikomeroglu**

---

**Chair, Department of Systems and Computer Engineering  
Prof. Rafik A. Goubran**

**Carleton University  
2002**

## **Abstract**

Relaying is found in Packet Radio and Ad-hoc networks whereby communications between mobile terminals are carried out in a distributed manner through intermediate relay nodes. When employed in a cellular network, this technique can be regarded as an Opportunity Driven Multiple Access (ODMA) scheme where relaying is turned to when communications to and from the base station for a certain mobile terminal are poor due to a lack of LOS (Line of Sight) or severe multipath fading.

There are many open challenges regarding this technology when incorporated into a cellular network, and they include: routing (or relay node/path selection) algorithms, channel allocation for relaying purposes, radio signal propagation characteristics between low height terminals, users' cooperation, and security. In this thesis, a simulation approach is taken to investigate the impact of different relay node/path selection and channel selection schemes (from among all employing channels already used in the adjacent cells) for relaying purposes on the users coverage, with and without power control. Our simulation results demonstrate that with a good relay node/path selection scheme and power control, relaying can have a significant improvement on the coverage. Furthermore, this improvement is quite insensitive to the channel selection schemes.

## **Acknowledgements**

First and foremost, I would like to express my deepest gratitude to my thesis co-supervisors, Professor Halim Yanikomeroglu and Professor David Falconer, for their time, guidance, and support. Furthermore, their experience, knowledge, and most of all interest in this research provide the source of motivation for my continued interest in this research work. For that and the valuable experience I have gained, is something that I will cherish for a long time.

As well, I am grateful to Nortel Networks for their financial support in this research. In addition, I would like to thank Mr. Narendra Mehta, the computer systems manager of the department of Systems and Computer Engineering, for his time and effort in installing the necessary software programs that were needed for this research work. Last but not least, I also would like to thank the ladies from the department of Systems and Computer Engineering for their constant reminder of important deadlines.

## Table of Contents

<b>Abstract</b> .....	<b>III</b>
<b>Acknowledgments</b> .....	<b>IV</b>
<b>Table of Contents</b> .....	<b>V</b>
<b>List of Figures &amp; Tables</b> .....	<b>VII</b>
<b>List of Acronyms</b> .....	<b>X</b>
<b>List of Symbols</b> .....	<b>XI</b>
<b>Chapter 1 INTRODUCTION</b> .....	<b>1</b>
1.1 Thesis Motivation .....	1
1.2 Thesis Objectives .....	3
1.3 Thesis Organization .....	4
1.4 Thesis Contributions .....	5
<b>Chapter 2 BACKGROUND ON RELAYING TECHNOLOGY</b> .....	<b>6</b>
2.1 Relaying in Mobile Packet Radio Networks .....	7
2.2 Relaying in Ad-hoc Networks .....	10
2.3 Relaying in Cellular Networks via mobile nodes .....	11
2.3.1 <i>Node Affiliation and Handoff Management</i> .....	12
2.3.2 <i>Radio Channel Consideration</i> .....	14
2.3.3 <i>FDD v.s TDD Consideration</i> .....	16
2.3.4 <i>Multiple Access Scheme Consideration</i> .....	17
2.3.5 <i>Summary</i> .....	19
<b>Chapter 3 RELAY NODE AND CHANNEL SELECTION SCHEMES</b> .....	<b>24</b>
3.1 Radio Propagation Model .....	24
3.2 Relay Node/Path Selection Schemes .....	27
3.2.1 <i>Selection based on Geographic Distance</i> .....	28
3.2.2 <i>Selection based on Path-loss</i> .....	29
3.3 Channel Selection Schemes .....	32
<b>Chapter 4 SIMULATION MODEL</b> .....	<b>40</b>
4.1 Environment & Parameters Assumptions .....	40
4.2 Model Assumptions .....	42
4.3 Simulation Algorithm .....	44
<b>Chapter 5 SIMULATION RESULTS</b> .....	<b>48</b>
5.1 Performance impact in a noise-limited system .....	48
5.2 Performance impact in an interference-limited system .....	52
5.3 Impact of relay node/path selection on Coverage .....	58
5.3.1 <i>Selection based on Geographic Distance</i> .....	58

5.3.2	<i>Selection based on Path-loss</i> .....	60
5.4	Impact of channel selection on Coverage .....	64
5.5	Impact of relay node/path selection on Coverage (Small Relay Node Set)..	66
5.6	Worst case performance vs. Best case performance .....	68
5.7	Impact of Adaptive Modulation and Power on Coverage .....	70
5.8	Impact of Adaptive Modulation and Power on Average Node Throughput..	74
<b>Chapter 6</b>	<b>DISCUSSIONS &amp; CONCLUSIONS</b> .....	<b>78</b>
6.1	Results Summary .....	78
6.2	Further Discussions .....	79
6.3	Future Research .....	83
<b>REFERENCES</b>	.....	<b>85</b>

## List of Figures & Tables

<b>Figure 1.</b> Example of a Radio Packet Network .....	8
<b>Figure 2.</b> A Scenario depicting areas of coverage holes .....	21
<b>Figure 3.</b> A Conventional solution via repeaters .....	22
<b>Figure 4.</b> A Novel solution via relaying using mobile terminals .....	23
<b>Figure 5.</b> Illustration of Smart Relay Node selection scheme .....	31
<b>Figure 6.</b> A block diagram of a relay path .....	31
<b>Figure 7.</b> Interfering links from one-tier cells for a node that is not being relayed .....	35
<b>Figure 8.</b> Interfering links from the relay nodes for a node that is not being relayed .....	36
<b>Figure 9.</b> Interfering links from the base stations for a node that is being relayed .....	37
<b>Figure 10.</b> Interfering links from the relay nodes for a node that is not being relayed .....	38
<b>Figure 11.</b> Flowchart of the overall simulation process .....	45
<b>Figure 12.</b> Flowchart of a simulation scenario with relaying incorporated .....	46
<b>Figure 13.</b> Flowchart of Adjacent-cell channel reuse scheme based on the Smart scheme .....	47
<b>Figure 14.</b> User Coverage vs. Subscriber Density (for 2x2 km cell size, <u>No Power Control</u> , Smart Relayer selection, Semi-Smart Channel selection) .....	50
<b>Figure 15.</b> User Coverage vs. Subscriber Density (for 2x2 km cell size, <u>Power Control</u> , Smart Relayer selection, Semi-Smart Channel selection) .....	50
<b>Figure 16.</b> User Coverage vs. Subscriber Density (for 1x1 km cell size, <u>No Power Control</u> , Smart Relayer selection, Semi-Smart Channel selection) .....	51
<b>Figure 17.</b> User Coverage vs. Subscriber Density (for 1x1 km cell size, <u>Power Control</u> , Smart Relayer selection, Semi-Smart Channel selection) .....	51
<b>Table 1.</b> Coverage performance for Fig. 18 corresponding to the case of no relaying .....	55
<b>Figure 18.</b> User Coverage vs. Subscriber Density (for 400x400 m cell size, <u>No Power Control</u> , Smart Relayer selection, Semi-Smart Channel selection) .....	56
<b>Figure 19.</b> User Coverage vs. Subscriber Density (for 400x400 m cell size, <u>Power Control</u> , Smart Relayer selection, Semi-Smart Channel selection) .....	57

<b>Figure 20.</b> User Coverage vs. <u>Maximum Relay Node Transmit Power</u> (for 400x400 m cell size, Power Control, Smart Relayer selection, Semi-Smart Channel selection) .....	57
<b>Figure 21.</b> User Coverage vs. Subscriber Density (for 400x400 m cell size, Power Control, <u>Shortest Path selection</u> , Semi-Smart Channel selection) .....	59
<b>Figure 22.</b> User Coverage vs. Subscriber Density (for 400x400 m cell size, Power Control, <u>Shortest Relay Hop selection</u> , Semi-Smart Channel selection) .....	59
<b>Figure 23.</b> User Coverage vs. Subscriber Density (for 400x400 m cell size, Power Control, <u>Max. Relay Node TxPower: 20 mW</u> , Semi-Smart Channel selection) .....	62
<b>Figure 24.</b> User Coverage vs. Subscriber Density (for 400x400 m cell size, Power Control, <u>Max. Relay Node TxPower: 1 W</u> , Semi-Smart Channel selection) .....	63
<b>Figure 25.</b> Frequency of relayer type (normalized by the subscriber density) vs. Subscriber Density (corresponds to result in Fig. 23) .....	63
<b>Figure 26.</b> User Coverage vs. Subscriber Density (for 400x400 m cell size, Power Control, <u>Max. Relay Node TxPower: 20 mW</u> , <u>Smart Relay Node selection</u> ) .....	65
<b>Figure 27.</b> User Coverage vs. Subscriber Density (for 400x400 m cell size, Power Control, <u>Max. Relay Node TxPower: 1 W</u> , <u>Smart Relay Node selection</u> ) .....	65
<b>Figure 28.</b> User Coverage vs. Subscriber Density (for a Smaller Relay Node Set, 400x400 m cell size, Power Control, <u>Max. Relay Node TxPower: 20 mW</u> , Semi-Smart Channel selection) .....	67
<b>Figure 29.</b> User Coverage vs. Subscriber Density (for a Smaller Relay Node Set, 400x400 m cell size, Power Control, <u>Max. Relay Node TxPower: 1 W</u> , Semi-Smart Channel selection) .....	67
<b>Figure 30.</b> User Coverage vs. Subscriber Density (for 400x400 m cell size, <u>No Power Control</u> , <u>Random Relayer selection</u> , <u>Random Channel selection</u> ) .....	68
<b>Figure 31.</b> User Coverage vs. Subscriber Density (for 400x400 m cell size, <u>Power Control</u> , <u>Smart Relayer selection</u> , <u>Smart Channel selection</u> ) .....	69
<b>Table 2.</b> Required SNR for BPSK and Multilevel QAM Modulation .....	72
<b>Figure 32.</b> User Coverage vs. Subscriber Density (for 400x400 m cell size, Power Control, <u>Adaptive Modulation</u> , Semi-Smart Channel selection) .....	73
<b>Figure 33.</b> Average Node Throughput vs. Subscriber Density (for 400x400 m cell size, Power Control, <u>No Adaptive Modulation</u> , Semi-Smart Channel selection) .....	75
<b>Figure 34.</b> Average Node Throughput vs. Subscriber Density (for 400x400 m cell size, Power Control, <u>Adaptive Modulation</u> , Semi-Smart Channel selection) .....	76

<b>Figure 35.</b> Percentage Use vs. Constellation Size (for 400x400 m cell size, Power Control, <u>Max. Relay Node TxPower: 20 mW</u> , <u>Subscriber Density: 8</u> , <u>Adaptive Modulation</u> , <u>Smart Relayer selection</u> , Semi-Smart Channel selection) .....	76
<b>Figure 36.</b> Percentage Use vs. Constellation Size (for 400x400 m cell size, Power Control, <u>Max. Relay Node TxPower: 20 mW</u> , <u>Subscriber Density: 64</u> , <u>Adaptive Modulation</u> , <u>Smart Relayer selection</u> , Semi-Smart Channel selection) .....	77

## List of Acronyms

<b>AMPS</b>	Advanced Mobile Phone System
<b>ARQ</b>	Automatic Repeat Request
<b>BER</b>	Bit Error Rate
<b>BPSK</b>	Binary Phase Shift Keying
<b>BSS</b>	Base Station Subsystem
<b>CDMA</b>	Code-Division Multiple Access
<b>DARPA</b>	Defense Advanced Research Project Agency
<b>EIRP</b>	Effective Isotropic Radiated Power
<b>FDMA</b>	Frequency-Division Multiple Access
<b>FDD</b>	Frequency Division Duplex
<b>FEC</b>	Forward Error Correction
<b>FER</b>	Frame Error Rate
<b>GHz</b>	Giga Hertz
<b>GPS</b>	Global Positioning System
<b>GSM</b>	Groupe Speciale Mobile
<b>HIPERLAN</b>	High Performance Radio LAN
<b>LOS</b>	Line of Sight
<b>MAHO</b>	Mobile-assisted handover
<b>MCHO</b>	Mobile-controlled handover
<b>MHz</b>	Mega Hertz
<b>ODMA</b>	Opportunity Driven Multiple Access
<b>PER</b>	Packet Error Rate
<b>QAM</b>	Quadrature Amplitude Modulation
<b>QoS</b>	Quality of Service
<b>SINR</b>	Signal-to-interference-plus-noise ratio
<b>SNR</b>	Signal-to-noise ratio
<b>TDD</b>	Time Division Duplex
<b>TDMA</b>	Time-Division Multiple Access

## List of Symbols

$\sigma$	Standard deviation
$\gamma_t$	SNR threshold
$\alpha$	rms value
$\alpha^2$	Time-average power of the received signal before envelope detection
$\gamma^*$	Maximum achievable carrier-to-interference ratio
$\gamma_i^c$	Carrier-to-interference ratio received at node $i$ on channel $c$
$\lambda^*$	Largest real eigenvalue
$B_c$	Set of base stations that use channel $c$
$d_o$	Reference distance
$d$	Distance between a transmitter to a receiver
$E\{U\}$	Expectation of the random variable $U$
$F$	Noise figure
$G_{ji}$	Path-loss coefficient between node $i$ and node $j$
$G_t$	Transmitter antenna gain
$G_r$	Receiver antenna gain
$I_{new}$	Interference due to the new link
$I_{old}$	Interference due to the existing link
$K$	Set of channels acceptable to be reused
$K_b$	Boltzmann's constant
$l_s$	Selected channel
$L$	Set of all channels available in the adjacent cells
$M$	Modulation level
$N$	Thermal noise Power
$n$	Path-loss exponent
$p_s$	Selected path
$P_j^c$	Transmitted power of node $j$ on channel $c$
$P_r$	Received power
$P_t$	Transmitted power
$PL$	Mean path-loss
$\text{Pr}[\text{SINR}]$	Probability of received SINR
$R_{inst}$	Instantaneous bit rate
$S_{avg}$	Average throughput per node
$T_{avg}$	Average node throughput
$T_s$	System temperature
$W$	Transmission Bandwidth
$\mathbf{Z}$	Matrix $Z$

## ***CHAPTER 1***

### **INTRODUCTION**

When it comes to coverage or capacity enhancement solution in a cellular network, significant effort has been placed at the system network or the system infrastructure. In addition to obvious means such as increasing transmitter power, antenna height and gain, such efforts can be seen by techniques like cell splitting, sectorized cells, and smart antennas (through various forms) in which the service provider attempts to put all of its resources at the network in order to achieve as close to 100% coverage as possible. The above solutions, however, involve planning, costs, and sometimes a long deployment period. These solutions may turn out to be cost-ineffective if only a small percentage of subscribers need to be further accommodated. In this situation, it is more advantageous to look for alternative techniques that involve less planning and are quick to deploy. One such technique is relaying via existing mobile terminals, in particular, for those mobile terminals that have a poor coverage from the base station. Their signals can thus be relayed by one or more terminals with a good link to the base station.

#### **1.1 Thesis Motivation**

Coverage has invariably been a major concern for cellular service providers. In a built up urban environment, the radio signal decays very rapidly as the distance between the transmitter and receiver increases. Moreover, if a mobile node happens to move into a region where there exists a large obstruction, which lies in the path between it and the desired base station, then the

signal is further weakened to the point where it cannot be detected cleanly due to the distortion from a stronger noise and/or interference power.

As a solution, service providers sometimes employ repeaters to extend the coverage to these areas, commonly known as dead spots or coverage holes, that are not covered by the base station [7,15,17]. In order for them to be effective, however, the location for these repeaters must be planned so that a clear LOS (Line of Sight) to the base station is obtained. Applications of repeaters are useful for extending the coverage to dead spot regions where there is a dense population such as: freeways, tunnels, and convention centers [17]. Nonetheless, the shortcoming is that this method becomes cost-ineffective if many sparse coverage holes, in which only a few mobile terminals are located, exist. Moreover, signal forwarding via repeaters is done “blindly”, which means that there is no provisioning of individual node’s quality of service requirement [7,15]. This is a crucial factor in a multimedia network where individual nodes have a different quality of service requirement such as a certain minimum Bit Error Rate (BER), end-to-end delay, or a minimum data rate. Accordingly, the above will not provide a viable solution in this type of system.

Conversely, relaying using mobile terminals can be an alternative or complementary method to repeaters; in this case, an individual terminal’s signal to whom the base station is intended, but cannot reach, is relayed by one or more mobile terminals which have a direct or intermediate link to the base station. Relaying can be beneficial for both base-to-terminal and terminal-to-base transmissions. Other potential benefits from this form of relaying include: fast deployment period, fewer infrastructures requirement, increased coverage, and peak power consumption reduction. In fact, due to these potential benefits, there has, recently, been an interest in deploying this technique in cellular systems, particularly for the third-generation systems [1,11,38]. Although there have been discussions on the benefits and shortcomings of integrating this technology in the future cellular systems, little actual research work has been

carried out on its performance analysis. In [36], relaying using fixed relay stations is presented which shows to be an effective mean in diverting traffic from a congested to a less-congested, neighboring cell, and thus improving the overall system capacity. However, the architecture presented there differs from this proposed architecture since fixed relay stations are used. The closest related work to this work is presented in [11] in which it is shown that relaying – via mobile terminals – in a cellular system results in an average power saving of 21 dB and an area coverage increase from 47%, corresponding to no relaying, to 80%. However, the model used in that article is a very simple one. For instance it only considers a single base station and thus does not take into account the interference effects, and furthermore it simply assumes that there are enough channels reserved for relaying purposes.

If a relay node is selected to which a node in need of relaying assistance has the least path-loss, it is expected that there will be a dramatic signal quality improvement at these relayed nodes. Furthermore, with improved path-loss, techniques such as adaptive modulation can be employed so that a higher data rate can be delivered to the destined receiver without requiring much greater power from the transmitter or forwarder. Therefore, a digital form of relaying is considered here (so that the noise is not propagated from one hop to the next); this is particularly important in broadband communications where the noise power may be high due to the high transmission bandwidth and/or high receiver noise figure. The received signal is first demodulated, and may be error corrected if necessary with coded signals, before being re-modulated and forwarded. Hence, this will require a slightly added complexity to the terminal devices.

## **1.2 Thesis Objective**

With the aforementioned established, the objectives of this thesis are as follows:

- To investigate whether relaying can improve the system performance – namely the user coverage.
- To investigate the sensitivity of the system performance to different relay node/path selection schemes.
- To investigate the sensitivity of the system performance to different channel selection schemes – from among those channels already used in the adjacent cells – for relaying purposes.
- To investigate the impact of the relay node's maximum transmit power level on performance improvement.
- To investigate the impact of adaptive modulation techniques on the average node throughput, when relaying is incorporated.

### **1.3 Thesis Organization**

This thesis is organized as follows. Chapter 2 provides a background to the relaying concept that began in packet radio networks and has now evolved into ad-hoc networks, both of which have no infrastructure. The concept is then considered for cellular networks; here we attempt to offer the benefits and shortcomings of its adoption in such a network where there exists an infrastructure. Chapter 3 describes the radio signal propagation model and its applicability to the relay node/path and channel selection schemes, where appropriate. Chapter 4 provides details of the environment parameter and model assumptions used to simulate a system that supports relaying. Chapter 5 provides the simulation results and discussions pertaining to the various aspects of investigations established in section 1.2. Finally, Chapter 6 provides concluding remarks based on the results obtained. Following that are discussions that should

provide further insights into this relaying technology. Finally, this chapter concludes with an introduction to issues for possible future study.

#### **1.4 Thesis Contributions**

For this thesis, a simulation approach has been taken to determine the potential benefits gained from relaying in a cellular system. Various results may offer beneficial contributions to the research community and these include:

1. A simulation analysis which verifies that relaying in a cellular network can have a potential impact on the system coverage.
2. A simulation analysis which verifies that in two-hop relaying, by choosing a relay path based on a scheme that gives a higher priority to the user terminal-to-user terminal hop, is more efficient than one that gives both hops (base station-to-user terminal and user terminal-to-user terminal) equal priority when the relay terminal has a resource constraint.
3. A channel reuse scheme proposal whereby channels from the adjacent cells, which are already being used, are further reused for relaying purposes.
4. A simulation analysis which verifies that relaying can help lower the peak power consumption of both the base station and the subscriber terminal.
5. A simulation analysis which verifies that power control plays a crucial role in achieving good performance improvement through relaying.
6. A simulation analysis which verifies that, in addition to coverage improvement, relaying in a cellular network can have further potential impact on individual node's average throughput through using an adaptive modulation technique to take advantage of the good link quality obtained from relaying.

## **CHAPTER 2**

### **BACKGROUND ON RELAYING TECHNOLOGY**

In this chapter we provide a brief background to the relaying technology, beginning with a technique used in packet radio networks, designed for military operations. This technology is now beginning to gain some ground in the commercial networks. The interest lies in the fact that a fast, easy to deploy communication medium can be established in a distributed fashion, without having to depend on an existing central controller or an infrastructure (this type of network is now known as ad-hoc network). The technology is, however, still in an immature state since current routing algorithms have not yet been proven to work under a large size ad-hoc network, and existing challenges such as Multicast support, QoS support, power-aware routing, location-aided routing have not been dealt with [27]. In its current state, this relaying technology is most attractive to those belonging to a small organization or group whose members need to communicate with each other or share information on a demand basis [21,27].

Conversely, in cellular networks, even though there are infrastructures, by way of the BSSs (Base Station Subsystems), to provide coverage to the subscribers, there still exist various coverage holes that need to be filled. Relaying via existing mobile terminals seems like a viable candidate solution to this coverage hole problem. Hence, in this chapter, we extend this concept further into cellular networks and offer the benefits and shortcomings to adopting such a technique in cellular systems.

## **2.1 Relaying in Mobile Packet Radio Networks**

Relaying began in packet radio systems whereby no infrastructure exists and mobile nodes communicate with each other via intermediate relay nodes [5,13,30,31]. The first relaying project was the DARPA (Defense Advanced Research Project Agency) project, which was designed for military operations [31]. Some of the characteristics found in this type of network include:

- Low bandwidth
- Highly dynamic due to node movement and bursty traffic
- High connectivity requirement in order to have a robust and reliable communication
- Store-and-forward routing of packets
- Shared radio channel
- Mainly broadcast-mode communication
- Low transmission range for the radio terminals
- Packets may be required to traverse many hops before reaching the destination

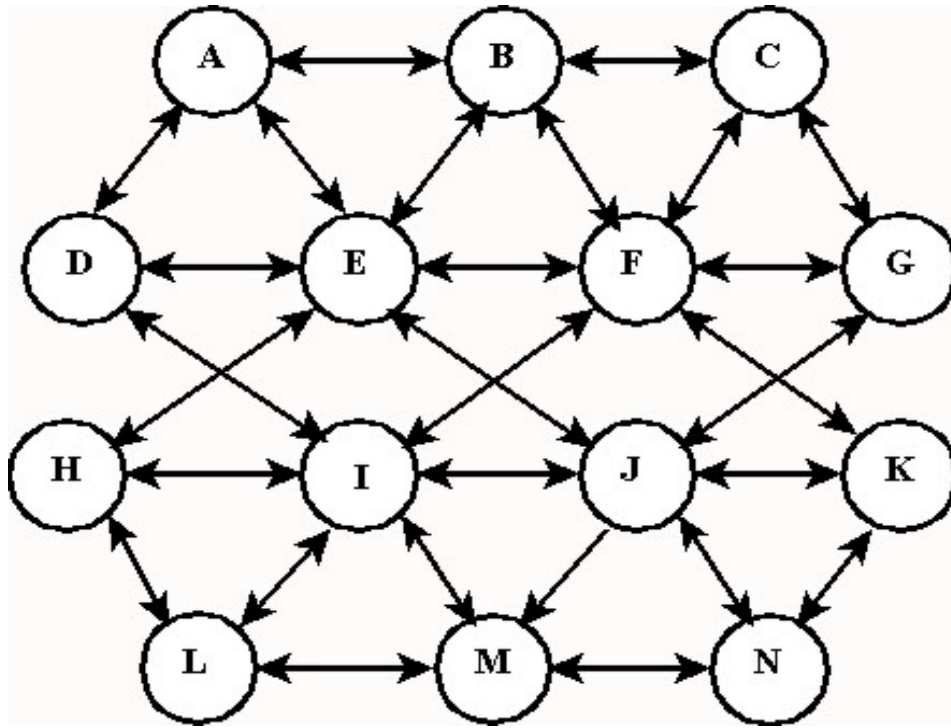

**Figure 1. Example of a Packet Radio Network**

Due to the above characteristics, some inherent problems exist in this type of system – namely hidden terminal and routing loop. Since nodes communicate with one another over a shared radio channel, neighboring nodes can hear one another when packets are being forwarded. On the contrary, a hidden terminal problem occurs when two or more nodes cannot hear one another's transmissions due to their physical separation, and upon simultaneous transmission they will cause a packet collision at the receiver that lies between them. A routing loop problem, on the other hand, occurs when a link failure notification from a node that is on the path from the source to the destination fails to reach the source node. Thus, the source node mistakenly thinks that it still has a good, but longer path to the destination via this route. Each node along this route, in turn, keeps incrementing the number of hops it thinks it has to the destination, and thus eventually creating a loop.

Accordingly, the routing objectives in this type of network have tried to avoid the aforementioned problems and to maximize the capacity, while at the same time, minimize the

number of hops, interference, and delay [13,31]. Some of these objectives, however, conflict with one another. Fig. 1 provides an example. If D wants to send a packet to G, the path that has the least number of hops, which is 3, is through E, F, G. However, if H simultaneously sends packets to K, then in order to avoid an interference, D is forced to reroute its packets through A, B, C, and G, which takes 1 hop longer.

As with routing in a wired network, routing in a wireless packet radio network involves a tradeoff between the efficiency and overhead complexity. For the scope of this thesis, we will not go into the details of every routing algorithm, but instead clarify a few important routing concepts. For a small to medium size network, routing can be managed to a certain degree.

Routing algorithms are divided into 3 categories: centralized, decentralized, and distributed [31]. Common to the problem encountered in a wired network, in a centralized routing scheme, when a link failure occurs, updates to the network topology incur a long delay since each node must wait for an update from the central server. Conversely, in decentralized routing (also known as link state), each node must determine its own connectivity and must flood this link-state information to every other node in the network. Once all link-state update information is flooded throughout the network, each node can then deduce the network topology and compute the routes to every destination. Meanwhile, in distributed routing (also known as distance vector), each node is required to broadcast information about the shortest distances it knows to destinations in the network. Upon receiving this broadcast, each corresponding node can then determine the distance to each destination via each neighbor and thus select the shortest path, and it then broadcasts this information to its neighbors [31].

When the network becomes large, however, the above routing algorithms must be extended to accommodate such a network while maintaining low latency and bandwidth requirement. Since it requires a longer time for the routing information to disperse in a large network, the time between routing updates must be decreased in order to maintain a constant

routing delay as the network grows; consequently this leads to too many routing update requirements. Furthermore, the bandwidth required for distributing routing information grows linearly with the size of the network, and therefore it may not be possible to accommodate such a large size network since the radio bandwidth in such a system is scarce. A solution to this network growth problem is to hide details of faraway parts of the network in the routing updates or to send out information about faraway parts of the network less frequently. This is achieved by using hierarchical routing, whereby the entire network is partitioned into hierarchy by forming clusters and super clusters [31].

## **2.2 Relaying in Ad-hoc Networks**

Current relaying networks have evolved into what is known as ad-hoc networks. There is still no infrastructure, but the purpose is now geared towards providing a communication medium on demand for commercial applications such as conferences, meetings, workshops, emergency services and so forth, so that instant network information can be readily accessible and shared among participants [27].

Routing algorithms have been improved so that problems such as hidden terminal and routing loop are either avoided or rare. Routing in mobile ad-hoc networks is divided into two main categories: table-driven and source-initiated (demand-driven) [27]. In table-driven routing, each node is required to have and maintain consistent and up-to-date routing information to every other node in the network, all the time, whether or not it needs a route. Routing updates to changes in the network topology are broadcast throughout the network. With this protocol, since routing updates are propagated constantly, it incurs substantial signaling overhead and consequently, bandwidth and power must be sacrificed. In on-demand routing protocol, however, each node would only attempt to discover a route when needed. If a link failure occurs

on the current route, the source node must initiate a new route discovery. Since this is done on a demand basis, signaling overhead is reduced quite substantially [21,27]. However, since there is a low connectivity establishment in this protocol, it is less robust compared to the former.

### **2.3 Relaying in Cellular Networks via Mobile Nodes**

Relaying in a cellular network – using other mobile terminals – differs from an ad-hoc network in that there now exists an infrastructure by way of the BSS. Based on this, the following advantages and disadvantages, relative to a conventional cellular network and an infrastructureless network, are observed:

#### *Advantages:*

- There is a central controller and all communications must go through it.
- Reduces peak power consumption by both the base station and the mobile node due to improved LOS and/or shorter distances between a given transmitter and receiver.
- Packet forwarding requires fewer hops.
- Hidden terminal and routing loop problems can be easily avoided.
- Routing is simplified since links are only established as needed.
- Provides a receiver capture effect, through power control & separate radio channels, which will result in a desired signal improvement.

#### *Disadvantages:*

- Requires a strategic relay node/path selection scheme.

- Requires additional channels for relaying purposes (although, this also applies in ad hoc networks).
- Requires a strategic handoff management.
- Requires cooperation among mobile nodes.
- May require a high subscriber density to be effective.
- Poses a security risk, without sufficient encryption techniques.
- Requires that nodes be able to transmit and receive on the same frequency; i.e. that nodes be able to communicate directly with other nodes, as well as with base stations.

### *2.3.1 Node Affiliation and Handoff Management*

Even though there is now a central controller, when relaying is needed, a mobile node must somehow be informed that such a relaying service is available in the system. It has been suggested in [1] that each node that has a good link (via direct or intermediate link) to the base station advertise its capability to support relaying by periodically emitting “BEACON” messages so that nodes in need of relaying assistance can listen for these beacons and at the same time assess their link quality to the neighboring nodes.

The factors for determining whether or not a certain node has the capability to support relaying requests, assuming that it has a good link to the base station, are: buffer space, transmit power, link bandwidth (radio channel) availability, and processing time. All of these can be determined at the negotiation time when a request is made. Assuming a node in need of relaying assistance has already decided on a relay node (following some scheme), it must then negotiate to determine whether or not its QoS (Quality of Service) requirements can be satisfied. Otherwise, it may be required to establish a new link with a different relay node.

Unlike in packet radio and ad-hoc networks, where it is necessary to have high node connectivity in order to provide a robust communication medium, in a cellular network, high node connectivity is not necessary since the base station link might become viable should the current relay connection is lost due to node mobility. In fact, source-initiated routing, as described in the previous section, seems a perfect candidate when a relay link is needed. If a rule is placed over the handoff sequence so that when handing off from a current relay link, a node must first seek for a link establishment with the base station, then only if this link is still bad, can it seek relaying support from another relay node. This will minimize the signaling overhead due to node discovery and so forth.

As such, three types of handoff must be distinguished: base station-to-relay node handoff, relay node-to-base station handoff, and inter-relay node handoff. For a given terminal, let  $\gamma_t$  be the minimum SNR (signal-to-noise ratio) threshold required; let  $\text{SINR}_{\text{BS}}(x)$  be the average received signal-to-interference-plus-noise ratio from the serving base station; let  $\text{SINR}_{\text{NEIGHBOR\_BS}}(x)$  be the average received signal-to-interference-plus-noise ratio from the best neighboring base station; let  $\text{SINR}_{\text{CURR\_RELAY}}(x)$  be the average received signal-to-interference-plus-noise ratio due to the current relay link; and let  $\text{SINR}_{\text{NEW\_RELAY}}(x)$  be the average received signal-to-interference-plus-noise ratio due to a new relay link. Then a handover from the base station to a relay node occurs if the following conditions are met:

$$\{ \text{SINR}_{\text{BS}}(x) < \gamma_t \} \text{ and a relay link exists } \forall \{ \text{SINR}_{\text{NEW\_RELAY}}(x) > \gamma_t \} \text{ and } \{ \text{SINR}_{\text{NEIGHBOR\_BS}}(x) < \gamma_t \}.$$

A relay node-to-base station handover occurs if the following conditions are met:

$$\{ \text{SINR}_{\text{CURR\_RELAY}}(x) < \gamma_t \} \text{ and } \{ \text{SINR}_{\text{BS}}(x) > \gamma_t \} \text{ and } \{ \text{SINR}_{\text{NEIGHBOR\_BS}}(x) < \gamma_t \} \text{ and } \{ \text{SINR}_{\text{NEW\_RELAY}}(x) < \gamma_t + h \},$$

where  $h$  is a predefined hysteresis value to discourage handing off to another relay link should the base station link become better.

Finally, an inter-relay node handover occurs if the following conditions are met:

$\{ \text{SINR}_{\text{BS}}(x) < \gamma_t \}$  and  $\{ \text{SINR}_{\text{CURR\_RELAY}}(x) < \gamma_t \}$  and a new relay link exists  $\forall \{ \text{SINR}_{\text{NEW\_RELAY}}(x) > \gamma_t \}$  and  $\{ \text{SINR}_{\text{NEIGHBOR\_BS}}(x) < \gamma_t \}$ .

As for handover control management, two types of handover control are observed – a mobile-assisted handover (MAHO) and a mobile-control handover (MCHO) [1]. A MAHO is carried out in a conventional manner, whereby the network makes a handover decision for the mobile terminal based on the received signal strength measurements reported from it. Meanwhile, a MCHO is carried out solely by the mobile terminal, whereby it performs its own link measurements and handover decision. In this process, the base station needs only be informed and instructed by the relay mobile terminal(s). According to [1], in a MCHO situation, since the handover decision does not involve the base station, the handover process can be initiated quickly and requires low signaling overhead.

### 2.3.2 Radio Channel Consideration

As was previously stated, one of the drawbacks with relaying in a cellular network is that extra channels are required – more specifically a separate channel is required for each hop that makes up the relay connection. It has been discussed in [4] to use the same channel for all the links making up the relay path. However, due to the positive feedback between the transmitter and the receiver side of the terminal, it would require highly complex signal processing and antenna engineering to make it feasible, all of which demand a highly complex terminal. Hence, at this point and for the scope of this thesis, we focus on a separate channel for each hop.

Depending on the traffic conditions and the availability of bandwidth, these additional channels can be acquired through one of the following means:

- If the system is not fully loaded, then through dynamic channel allocation, some idle channels from a less congested cell can be placed on the available channel pool so that they can be used – for relaying purposes – in a more congested cell where communication via relaying is in effect, in addition to the conventional communication method. However, if the system eventually becomes loaded, then a decision must be made whether to continue to allow relaying or to take back these channels in order to serve new subscribers.
- If a large spectrum bandwidth is available, a certain portion of it can be reserved for relaying purposes. However, bandwidth is usually scarce and it is not economical to reserve extra bandwidth for relaying purposes, while it could be used to serve new subscribers instead.
- Or if the interference can be managed among different providers' serving area, then using the unlicensed band (902 MHz - 928 MHz, 2.4 GHz - 2.483 GHz, 5.725 - 5.85 GHz [35]) for relaying purposes might be a cost-effective method.

However, since the spectrum is a scarce resource and there are outstanding issues with regard to the use of the unlicensed band [35], in this thesis study we will, instead, investigate a situation where no channels are reserved for relaying purposes and all the cells are fully loaded (so all the channels are used). Hence, we propose to reuse the channels from the adjacent cells. By doing so, we run the risk of causing potentially excessive co-channel interference. Therefore, tight power control and careful channel selection may be necessary. Furthermore, it is anticipated that with a good relay node/path selection scheme, the required forwarding power will be low. This should further minimize this additional interference.

Assuming fully loaded cells and no reserved channels for relaying purposes serve the following two reasons:

- 1) This way every mobile node is always active and ready to relay for another.

- 2) As well, this represents the worst-case interference scenario – since everybody is always transmitting.

### 2.3.3 FDD v.s TDD Consideration

In the context of relaying in cellular networks, TDD would offer more advantages over FDD for the following reasons:

- TDD offers the link channel reciprocity since the same frequency bandwidth is used for both downlink and uplink. Therefore, while having the channel state conditions in one direction, the channel state condition of the opposite direction can be reliably deduced. This is particularly useful in relaying since many channel state estimations are required.
- TDD offers more flexibility in terms of channel bandwidth management between the downlink and the uplink. This is useful in the context of relaying since the channel bandwidth can be adjusted to accommodate the traffic asymmetry between the downlink and the uplink direction.
- TDD allows communications over a single physical radio channel and thus simplifies the subscriber terminal since a duplexer is not required [24]. This feature is even more beneficial with relaying if the relay terminal has to support more than one terminal.
- The existence of the guard period in the conventional TDMA/TDD standard is adequate for avoiding any potential spill-over into the adjacent channel transmissions since communications via relaying is short in range and therefore is localized to the vicinity of the relay node and its few neighbors [38].

#### 2.3.4 Multiple Access Scheme Consideration

FDMA is the basic, fundamental multiple access scheme which was designed mainly for analog systems; therefore it will not be considered here. Hence, for the following, we examine the benefits and shortcomings between TDMA and CDMA multiple access schemes in the context of relaying in a cellular network:

##### *Advantages of TDMA over CDMA:*

- When relaying, the resources (such as battery power, buffer space and so forth) of the relay node are consumed. The more nodes supported, the faster the draining of the resources of the relay node. One particular interesting property about the TDMA scheme is that transmission takes place on a timeslot basis, meaning each node transmits only on a certain allotted timeslot. Thus, when relaying and following our proposed adjacent-cell channel reuse scheme for relaying purposes, a particular relay node would only forward (which implies a store-and-forward mechanism) to each of its relayed nodes (nodes whose traffic is being relayed) according to each allocated timeslot and not to all simultaneously. Therefore, the instantaneous transmitted power required will not necessarily increase with the number of nodes supported. The same cannot be said about an FDMA or CDMA system. Although each system requires the relay node to transmit to each of its relayed nodes on either a different frequency carrier or code, respectively, the forwarding may be done simultaneously, thus requiring higher instantaneous transmit power.
- In our study, which only considers the downlink direction, when a node cannot communicate directly with the base station and thus requires relaying assistance, its channel is assumed used by the base station for the purpose of transmitting its signal to its selected relay node. In a data

communication network, where traffic tends to be bursty, these timeslot(s) can be used by the base station to transmit the traffic for the relay node when there is no traffic to send to its relayed node(s). Hence, at times, this certain relay node will experience higher data throughput.

*Disadvantages of TDMA over CDMA:*

- The use of store-and-forward poses a delay which certain traffic signals such as voice may not tolerate.
- Handing off requires a break from the current connection before making a new connection. Thus, if the new connection is not done in a timely manner, the relayed node may experience a QoS degradation.
- Due to the nature of a time based access scheme, rigid time scheduling is required [9,30].

*Advantages of CDMA over TDMA:*

- CDMA has a special feature called soft handoff whereby a node is not required to break the current connection before establishing a new one [10]. Since at any given time it is allowed to be affiliated with more than one base station for soft handoff purposes, this feature can be extended to include relay nodes as potential serving stations. This will ease the handoff transition from base station-to-mobile node to mobile node-to-mobile node or vice versa, and in so doing avoid jeopardizing the quality of service of the relayed node.
- Since this is not a time based access scheme, the forwarder is not required to store the packets received before forwarding. This allows for concurrent forwarding of packets if the relay node supports more than one node.

### *Disadvantages of CDMA over TDMA:*

- A unique spreading code is required for each relayed node supported. Hence, more orthogonal codes are needed to concurrently support both conventional communications via the base station and communications via relaying. Perfectly orthogonal codes are needed in order to minimize the intra-cell interference as much as possible. Since in CDMA the same carrier frequency is reused by every subscriber in the cell, the most dominant interference is caused by the subscribers from within the same cell if they are not transmitting on perfectly orthogonal codes.
- One of the inherent problems in CDMA is achieving synchronization, especially in the uplink direction [10,37]. With asynchronous operations, the spreading codes are not orthogonal to one another. This leads to interference problems, and as more active links are present, the more serious this problem becomes. In both downlink and uplink, relaying would further worsen this problem since there would be more asynchronous communications going on among mobile terminals.

### *2.3.5 Summary*

Since this form of relaying has not been adopted in cellular systems before, it is expected it will require significant research and understanding before it can be fully realized. However, as a preliminary observation, the following benefits are expected to be realized if it is adopted in cellular systems:

- Increased coverage
- Decreased peak and average power consumption

- Increased spectral efficiency (due to a combination of adaptive modulation and our proposed adjacent-cell channel reuse scheme for relaying purposes)
- Decreased deployment period
- Increased node throughput (particularly for those located near the edge of the cell)
- Decreased infrastructure requirement

Finally, as a summary, Fig. 2 below, depicts a scenario where mobile terminals at certain locations, in particular at the cell edge, have a poor link to the base station. Fig. 3 illustrates one solution conventionally used by service providers to extend the coverage to these regions. Notice the number of repeaters that are necessary if all nodes with a poor coverage from the base station are to be accommodated via repeaters. Further, Fig. 4 conveys our proposed solution, as has been discussed thus far.

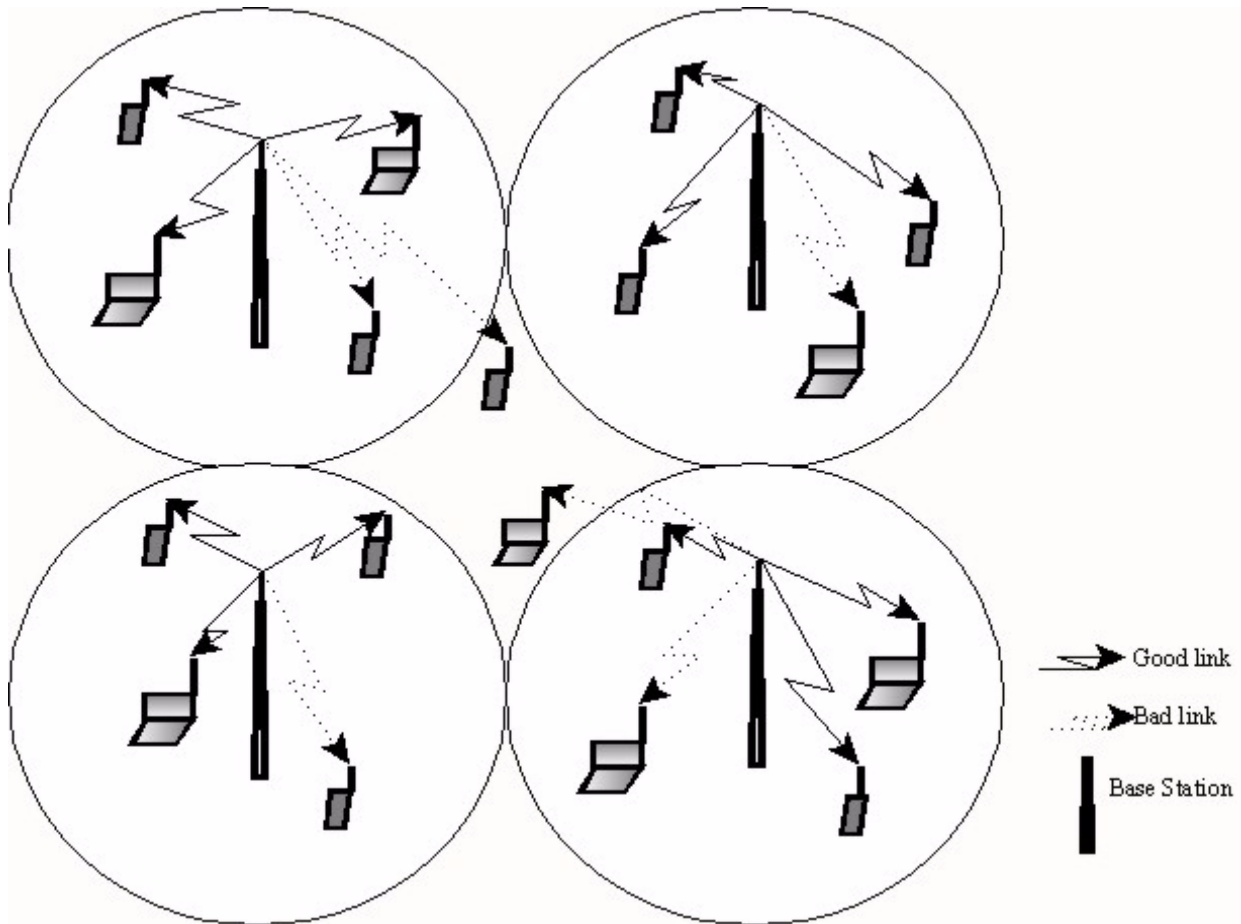

**Figure 2.** A scenario depicting areas of coverage holes or dead spots at which point the signal from the base station cannot cover or reach the mobile nodes at these locations.

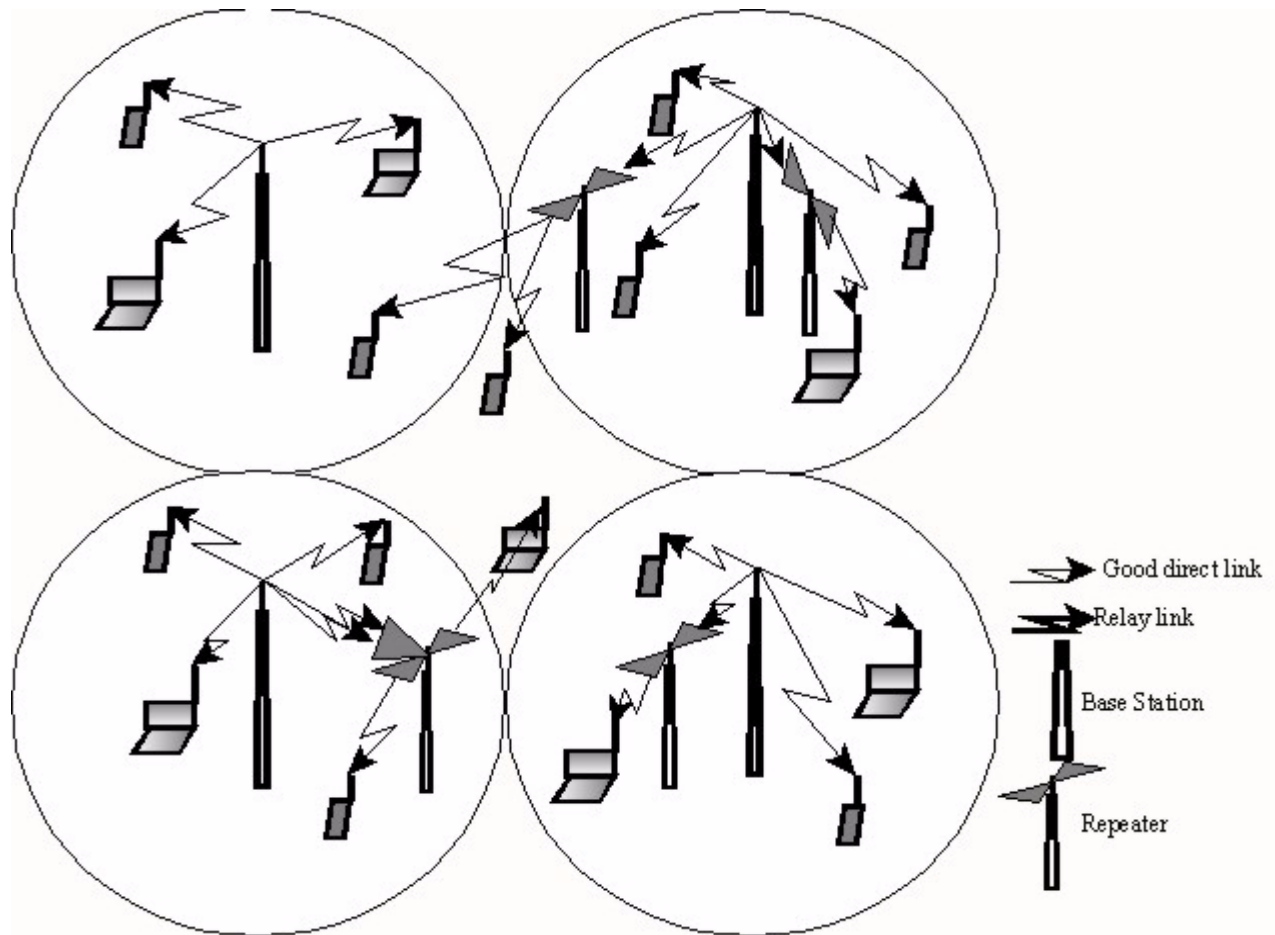

**Figure 3. A conventional solution to the coverage problem presented in Fig. 2 by using repeaters to extend the coverage to these locations.**

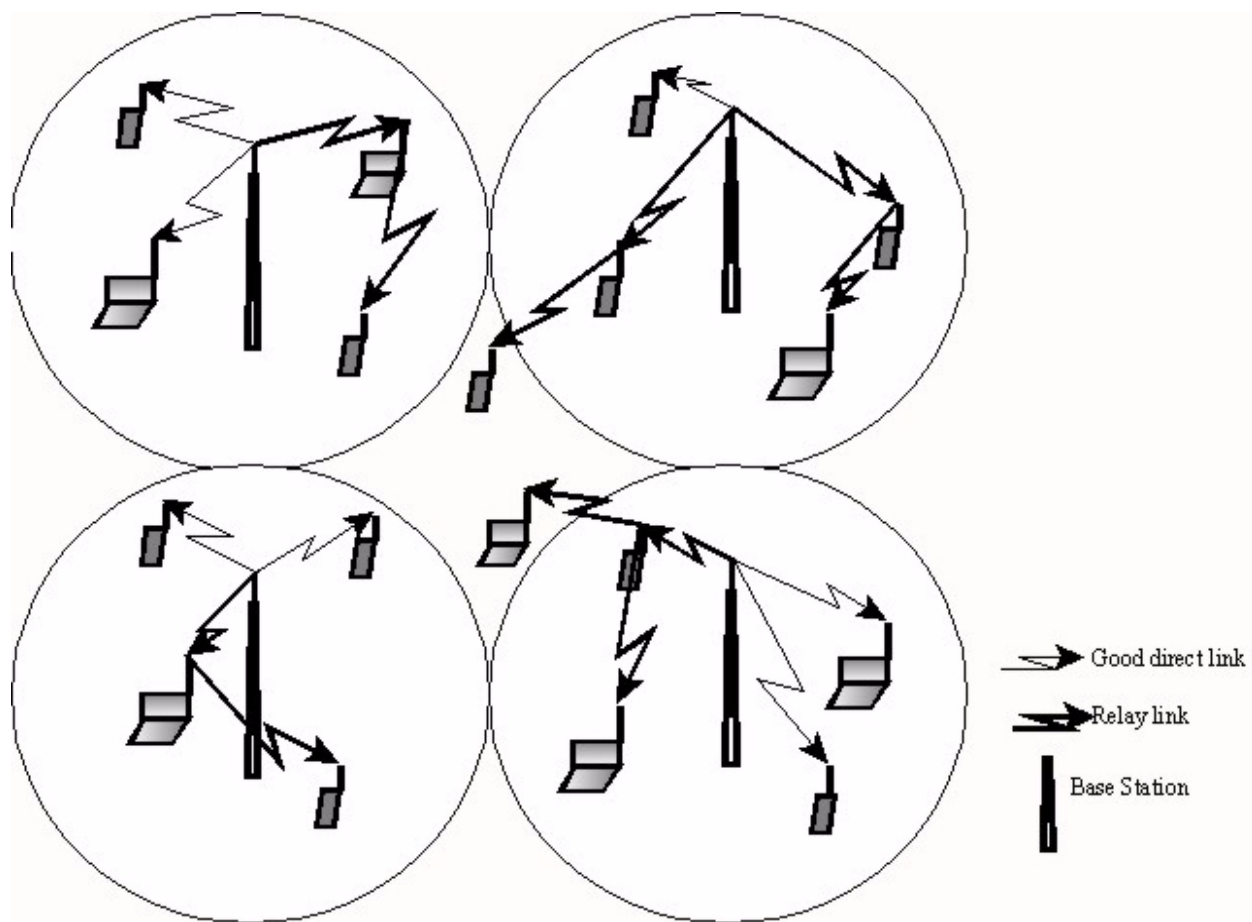

Figure 4. A novel solution to the coverage problem presented in Fig. 2 by using other mobile nodes with a good link to the base station to act as a relay node for those with a poor link.

## **CHAPTER 3**

### **RELAY NODE AND CHANNEL SELECTION SCHEMES**

This chapter deals with the propagation path-loss model (due to distance attenuation and lognormal shadow fading) and Rayleigh fading which together characterize the radio propagation channel. Furthermore, we first define the two relay node/path selection schemes in which we use only the geographic distance as the selection criterion. Then, we define the three relay node/path and channel selection schemes in which we use the path-loss (due to distance attenuation and lognormal shadow fading) as the selection criterion.

#### **3.1 Radio Propagation Model**

In an urban environment, the radio signal is attenuated severely as the distance between the transmitter and the receiver increases. The severity of this attenuation is inversely proportional to the distance between the transmitter and receiver raised to some exponent. This propagation exponent is commonly found to lie between 3.5 and 4 in an urban environment. Therefore, the average received power for a certain mobile node can be represented by the following formula [24]:

$$P_r = P_t \left( \frac{G_t G_r}{PL} \right), \quad (1)$$

where  $PL$  is the mean path-loss and is described by the following equation:

$$PL = \left( \frac{4\pi d_o}{\lambda} \right)^2 \left( \frac{d}{d_o} \right)^n, \quad (2)$$

where  $G_t$  &  $G_r$  are the antenna gain of the transmitter and receiver respectively;  $d_o$  is a reference distance at free space;  $d$  is the distance between the transmitter and the receiver, and  $n$  is the propagation exponent.

Furthermore, the actual received signal will deviate from the above average. This deviation is due to the shadowing effect caused by large obstructions such as tall buildings and trees. This effect, also known as the large-scale variations, is referred to as lognormal shadowing [24,35]. The variation in the received signal power, when measured in a log scale (in dB), has a Normal distribution. The depth of this fade variation is measured by the standard deviation and is usually represented by  $\sigma$ . Again, in an urban environment,  $\sigma$  ranges from 10 to 14 dB [24]. Thus, in order to account for the effect of shadow fading, (1) can be further written as:

$$P_r = P_t \left( \frac{G_t G_r}{PL} \right) 10^{\frac{X}{10}}, \quad (3)$$

where  $X$  has a log-normal distribution. If we combine (2) and (3) and express it in log scale, we obtain the following:

$$P_r[dBm] = P_t[dBm] - 10 \log \left( \left( \frac{1}{G_t G_r} \right) \left( \frac{4\pi d_o}{\lambda} \right)^2 \right) - 10 \log \left( \frac{d}{d_o} \right)^n + X_\sigma, \quad (4)$$

where  $X_\sigma$  now has a Normal distribution ( $N \sim (0, \sigma)$ ).

Besides the large-scale variations due to shadowing, the radio signal also experiences the small-scale variation effects due to multipath fading. This effect occurs quite commonly in a built up environment where there is no clear LOS between a given transmitter and receiver. The radio wave is broken into multiple components either due to scattering or diffraction when encountering objects that are smaller in dimension compared to its wavelength. Moreover, it could also result in a reflection if it encounters objects that are larger in dimension compared to its wavelength [24,35]. When multiple versions of this wave arrive at the receiver having different amplitude, phase, and delay, they add up either constructively or destructively.

Depending on the time delay difference between these multiple components, which is dependent upon the channel coherence bandwidth and the signal transmission bandwidth, the following results may be observed:

- Rapid fluctuations in the signal strength over a small travel distance or time interval which, at times, result in deep fading.
- Random frequency modulation due to varying Doppler shifts on different multipath components.
- Time dispersion caused by multipath propagation delays [24].

Each multipath component can be modeled by the sum of two independent complex Gaussian random variables. The magnitude (envelope) of this sum has a Rayleigh distribution, which has the following probability density function [23, 24]:

$$f_y(Y) = \frac{y}{\alpha^2} e^{-\frac{y^2}{2\alpha^2}}, \text{ for } y \geq 0, \alpha \geq 0, \quad (5)$$

where  $\alpha$  is the rms value of the received voltage signal before envelope detection, and  $\alpha^2$  is the time-average power of the received signal before envelope detection.

For simulation purposes, if we let  $U$  and  $V$  be two Gaussian random variables with a 0 mean and a standard deviation of 1, then from these two random variables we can derive another random variable which has a chi-square distribution according to the following:

$$Y^2 = \frac{1}{2}U^2 + \frac{1}{2}V^2, \forall E\{Y^2\} = \frac{1}{2}E\{U^2\} + \frac{1}{2}E\{V^2\} = 1, \quad (6)$$

such that  $Y^2$  has a chi-square distribution with a 1 mean and 2 degrees of freedom. The envelope, or in mathematical term, the square root of  $Y^2$  ( $\sqrt{Y^2} = Y$ ) follows a Rayleigh distribution. Now, to also incorporate the Rayleigh fading effect into the model, (3) can be further written as:

$$P_r = P_t \left( \frac{G_t G_r}{PL} \right) 10^{\frac{x}{10}} Y^2 \quad (7)$$

For the relay node and channel selection schemes that follow, the selection is carried out based on only the large-scale variations due to path-loss (which includes distance attenuation and shadow fading); since it would be impractical to perform inter-relay node and inter-channel hand-off based on multipath fading. However, Rayleigh fading is incorporated in the user coverage evaluation.

### **3.2 Relay Node/Path Selection**

Similar to the wired network, choosing a relay path is actually a routing problem. However, unlike in a wired network, choosing a relay path using merely the geographic distance as the selection metric is not as efficient as using the path-loss since the radio link quality varies greatly from one hop to the next, depending on whether or not there lies an obstruction between a given transmitter and receiver. Nonetheless, routing based on the geographic distance can be carried out quite simply and require minimal overhead, especially with the aid of GPS (Global Positioning System) technology.

In Oct. 1996, the FCC issued a report and order for all wireless carriers to provide E-911 service to all wireless callers [25,26]. In addition to other information, the location information provided (to the Public Safety Answering Point) must consist of the latitude and longitude estimate of the caller's position and must be within an accuracy of 125 m RMS 67% of the time [26]. Two types of location technology are available: a handset-based whereby location information of the handset is attained via GPS from a network of satellites or network-based by exploiting the cellular infrastructure to obtain geolocation information of the user terminal [25,26]. According to [26], current GPS receivers can determine their position within as good an accuracy of 50 m.

Coupled with the location information, relay node discovery can be carried out simply and quickly by the base station for the node that requires relaying assistance, or by the node itself, assuming that it, too, has location coordinates of the nodes that are within its vicinity. In fact, location information is being proposed in Ad Hoc networks for routing in order to reduce the routing overhead and to maintain a small routing table at the mobile nodes [14,16]. For instance, in [14] location information is proposed to be used in packet forwarding. Each source node obtains its location position via GPS and as well the location position of every other node in the network which it learns over time, through routing messages, and maintains in its routing table. When a packet needs forwarding, the source node will forward it to the neighbor node that is closest to the destination. In [16], location information is exploited so that the search space for routing messages is confined to a small zone in the network; this has the advantage of reducing the routing overhead.

### 3.2.1 Selection based on Geographic Distance

In the following, we investigate two relay node selection schemes in a two-hop relaying network: the first is a scheme that makes the selection based on the shortest overall path, while the second scheme is based on the shortest relay hop (mobile node-to-mobile node hop), among the candidate relay paths. For the following, let  $N$  denote the set of candidate relay nodes defined as the nodes which have an adequate link to the BS. Let  $d_{n_1}$  and  $d_{n_2}$  be the distances associated with the first (between the base station to the candidate relay node) and the second hop (between the candidate relay node to the relayed node of interest), respectively, along the  $n^{\text{th}}$  route,  $n \in N$ . Then the selected path,  $p_s$ , is determined as follows in each selection scheme:

- Shortest Path Selection Scheme (first scheme):

$$p_s = \arg \min_{\text{all } n \in N} (d_{n_1} + d_{n_2}) \quad (8)$$

- Shortest Relay hop Selection Scheme (second scheme):

$$p_s = \arg \min_{all\ n \in N} (d_{n2}) \quad (9)$$

### 3.2.2 Selection based on Path-loss

Since the path-loss associated with each link varies from location to location, to have an efficient routing algorithm, it would be desirable to have global path-loss information for the different links in a given cell. One of the benefits from using an efficient routing scheme is power savings and this, in turn, translates into less interference caused to other co-channel links nearby. Nonetheless, this benefit must be weighted against the signaling overhead involved in order to obtain this information. This trade-off becomes even more apparent in a large system involving many hops.

In the following, we investigate three relay node selection schemes in a two-hop relaying network: the first is a scheme that makes the selection based on a route that has the lowest bottleneck (in terms of path-loss); the second is based on the path-loss information only of the second hop – between each candidate relay node to the relayed node of interest (while knowing that the link quality of each candidate relay node to the base station is good); the third is based on a random selection (without considering the path-loss associated with either link). The main purpose of these investigations is to determine the benefits gained from having additional information about all the links that constitute the relay path. Thus, this will determine the trade-off between the efficiency of the more complex scheme, namely the first, compared to those with less complexity such as the second and third scheme.

Thus, for the following, let  $PL_{n1}$  and  $PL_{n2}$  be the path-losses associated with the first (between the base station to the candidate relay node) and the second hop (between the candidate relay node to the relayed node of interest), respectively, along the  $n^{th}$  route,  $n \in N$  (same

definition as in section 3.2.1). Then the selected path,  $p_s$ , is determined as follows in each selection scheme:

- Smart Selection Scheme (first scheme):

$$p_s = \arg \min_{all\ n \in N} (\max \{PL_{n1}, PL_{n2}\}) \quad (10)$$

- Semi-Smart Selection Scheme (second scheme):

$$p_s = \arg \min_{all\ n \in N} \{PL_{n2}\} \quad (11)$$

- Simple Selection Scheme (third scheme):

$$p_s = \text{rand}(N) \quad (12)$$

Fig. 5 below provides an example based on the Smart selection scheme; note that the selected route, indicated by the links with bold arrows, has the lowest path-loss among the higher ones on each route. Note also that the number of independent routes in this case should correspond to the number of candidate relay nodes. If the number of candidate relay nodes is large, however, the overhead involved in link quality measurements and information exchanges between the base station and the candidate relay nodes, and between each candidate relay node and the relayed node of interest, may be enormous. Therefore, for practical purposes the number of potential relay nodes should be limited.

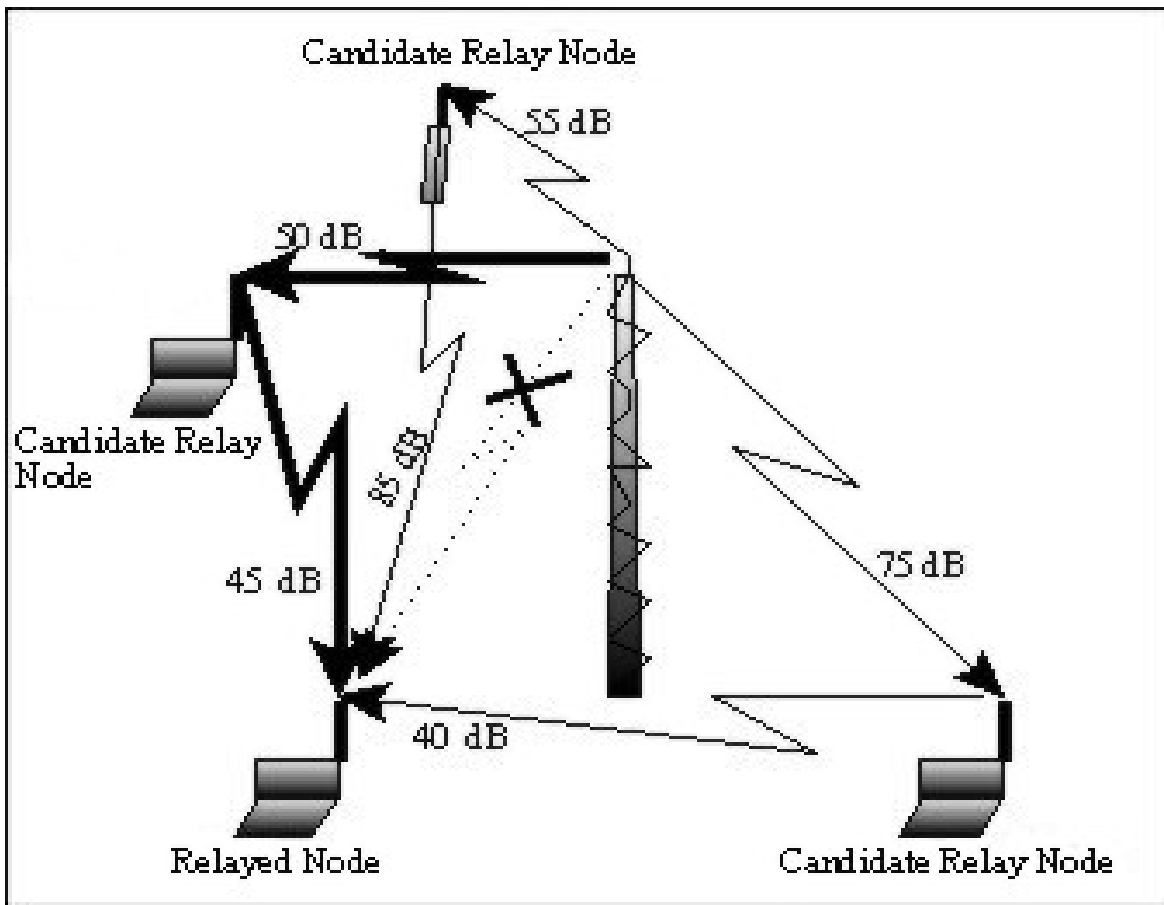

Figure 5. An illustration of relay node selection, using path-loss as the decision criterion, based on the Smart Selection scheme.

The difference between the Smart & Semi-Smart selection can be further distinguished through the following diagram:

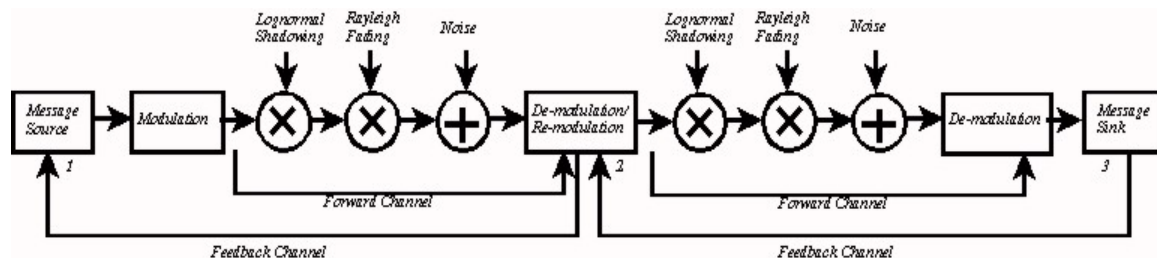

Figure 6. A block diagram of a relay path (shown here to include the effects of both Lognormal shadowing & Rayleigh fading) which is made up of two hops; the figure illustrates the importance of the link at 2 which governs the link quality at 3 when link 1 has a higher resource constraint than link 2.

According to the Smart scheme, among the paths available, it tries to find one that has the lowest bottleneck (best among the worst with respect to path-losses). However, at times when the relay node has a power constraint, then the link between the relay node and the relayed node will dictate the quality of service at the relayed node. Thus, in this kind of situation, the Semi-Smart scheme is more efficient than the Smart scheme since it always selects, among the candidates, a relay node to which the relayed node of interest has the lowest path-loss and therefore demanding the least transmit power to reach it.

On the other hand, when the first link has a higher constraint than the second link, then the Smart scheme is more efficient than the Semi-Smart scheme since it considers both links and finds the best of the worst links, among the candidate relay paths. Referring to Fig. 6 above, the Semi-Smart scheme overlooks the fact that there is a possibility that there may not be enough resources at 1 through 2 to satisfy the node at 3. Thus, for a given packet, if a lower SINR than the minimum required by the node at 3 is received at 2, then without any form of error control technique, this packet has a high probability of error at node 3.

### **3.3 Channel Selection**

Since our model assumes no reserve channels, channels from the adjacent cells will be acquired for relaying purposes. By doing so, we risk creating excessive interference that could lead to service interruptions at some links. To minimize this risk, tight power control and careful channel selections may be necessary. In the following, three schemes are presented among which a trade-off between efficiency and the overhead complexity is involved. The multiple access scheme considered here is based on TDMA where a channel is uniquely identified by a timeslot and a frequency carrier. Furthermore, the following schemes apply to the downlink scenario only, although similar derivations can be derived for the uplink scenario.

Let  $\gamma_i^c$  be the carrier-to-interference ratio received at the relayed node  $i$ , on channel  $c$ , and  $B_c$  the set of all base stations that use channel  $c$  plus the relay node  $j$  which also uses channel  $c$  for relaying purposes. Then,

$$\gamma_i^c = \frac{(G_{ji}P_j^c)}{\sum_{k \in B_c, k \neq j} (G_{ki}P_k^c)}, \quad (13)$$

where  $G_{ji}$  is the path-loss coefficient (as defined in (3)) between the relayed node  $i$  and the relay node  $j$ , and  $P_j^c$  is the transmitted power of the relay node  $j$ . Similarly,  $G_{ki}$  are the path-loss coefficients between the relayed node  $i$  and each co-channel base station  $k$  whose channels are being probed for reuse, and  $P_k^c$  is their corresponding transmitted power. Then, for:

- Smart Channel Selection, the channel selected,  $l_s$ , is :

$$l_s = \arg \max_{all\ c \in K, K \subset L} (\gamma_i^c), \quad (14)$$

where  $L$  is the set of all channels available in the adjacent cells, and  $K$  is the subset of  $L$  which denote the reusable channels. To determine whether a given channel,  $l$ , is reusable, a path-loss or link gain matrix of the active links that are associated with this channel plus that of the new candidate relay link is established. Let  $B_l$  denote the set of these active links, and let  $\mathbf{G}$ , where  $\mathbf{G} = \{G_{ij}\}$ , be the link gain matrix of these active links. With  $q$  mobile nodes involved  $\mathbf{G}$  will be a  $q \times q$  matrix. A new matrix derived from  $\mathbf{G}$  is obtained by normalizing each row vector in  $\mathbf{G}$  by the desired link gain of each first element in that row, such that:

$$\mathbf{Z} = \{Z_{ij}\}, \text{ where } Z_{ij} = \frac{G_{ij}}{G_{ii}}, \text{ for } i = 1 \dots q, j = 1 \dots q, \quad (15)$$

where  $G_{ii}$  is the desired link gain of mobile node  $i$ .

Since the matrix  $\mathbf{Z}$ , by definition, is a nonnegative matrix (all elements are nonnegative) and owing to the theory of nonnegative matrices originally due to Perron, et. al, which is presented in

more details in [20] and references therein, the following relation must hold if all the co-channel links involved with the channel of interest were to be active simultaneously:

$$\frac{(1+\gamma_t)}{\gamma_t} \mathbf{P} \geq \mathbf{Z} \mathbf{P}, \text{ where } \gamma_t \text{ is the minimum threshold value.} \quad (16)$$

A maximum achievable  $\gamma$ ,  $\gamma_{B_l}^*$ , is then determined from the largest real eigenvalue,  $\lambda^*$ , of this matrix  $\mathbf{Z}$ , according to the following [20]:

$$\gamma_{B_l}^* = 1/(\lambda^* - 1) \quad (17)$$

If  $\gamma_{B_l}^* \geq \gamma_t$ , then there exists a positive power vector such that all the links belonging to the co-channel set of the channel under question can be active simultaneously. Now, from the set  $L$  the subset  $K$  is formed as follows:  $l \in K$ , if  $\gamma_{B_l}^* \geq \gamma_t$ , and  $l \notin K$  if  $\gamma_{B_l}^* < \gamma_t, \forall l \in L$ .

- Semi-Smart Channel Selection, the channel selected,  $l_s$ , is :

$$l_s = \arg \max_{all\ c \in L} (\gamma_i^c) \quad (18)$$

- Simple Channel Selection, the channel selected,  $l_s$ , is :

$$l_s = \text{rand}(L) \quad (19)$$

What makes (14) a “smart” scheme is the fact that each channel is probed first for its effective  $\gamma$  at all the nodes involved, and among those that are acceptable to be reused, only the one that results in the highest  $\gamma$  at the relayed node is selected.

The Semi-Smart selection scheme is similar to the Smart scheme; the only exception is that the reusability check is not performed. With this scheme, the signaling overhead is reduced quite significantly. However, its performance is expected to be inferior to that of the Smart scheme. Meanwhile, the random selection scheme simply makes a channel selection on a random basis irrespective of the quality of the links affected by the chosen channel. This scheme

involves the least overhead, but neither the service continuity of the active links nor the service of the relayed node link is guaranteed. Thus, it is expected to offer the worst performance improvement.

Figs. 7, 8 and 9, 10 illustrate a basic configuration of co-channel links, for the worst possible case of interference, for a node that is not being relayed and one that is, respectively, when channels from the adjacent cell are reused. In the figure, the solid arrows represent the desired links, while the dashed arrows represent the interfering links. The cell cluster size is 4, as shown in bold in Fig. 7 below.

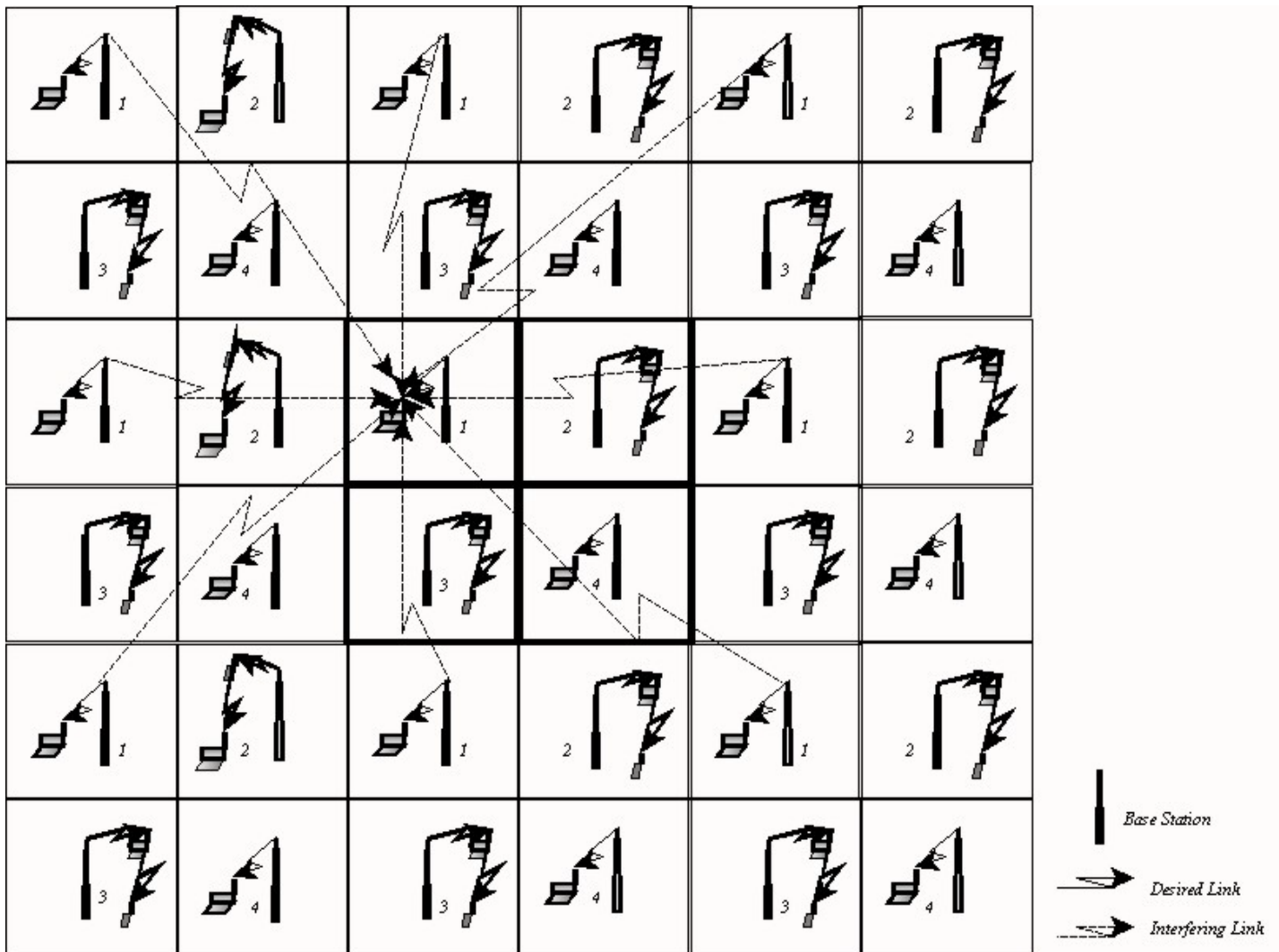

**Figure 7. Co-channel interfering links from one tier away for a node that is not being relayed.**

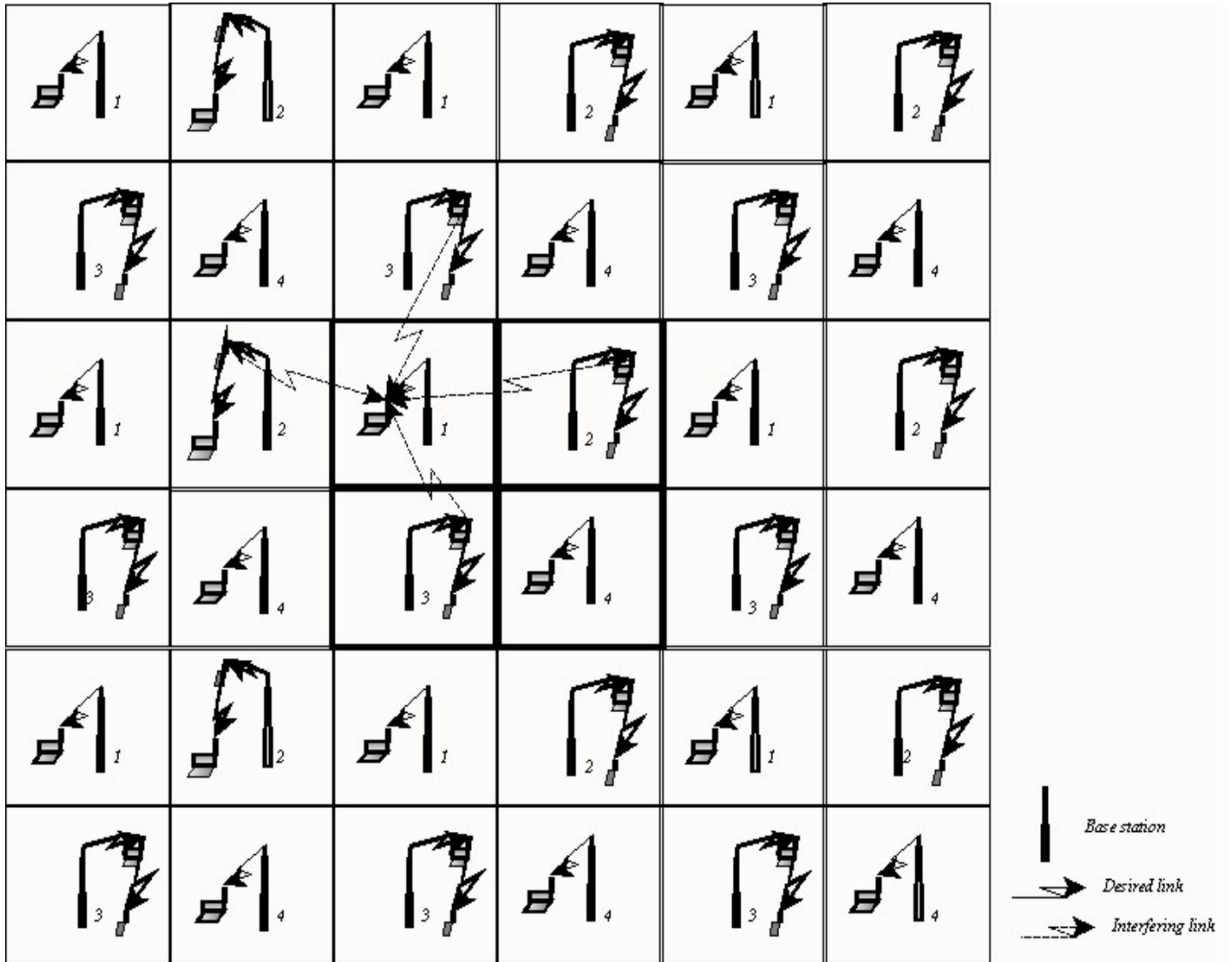

Figure 8. Co-channel interfering links from the adjacent cells, due to adjacent-cell channel reusing for relaying, for a node that is not being relayed.

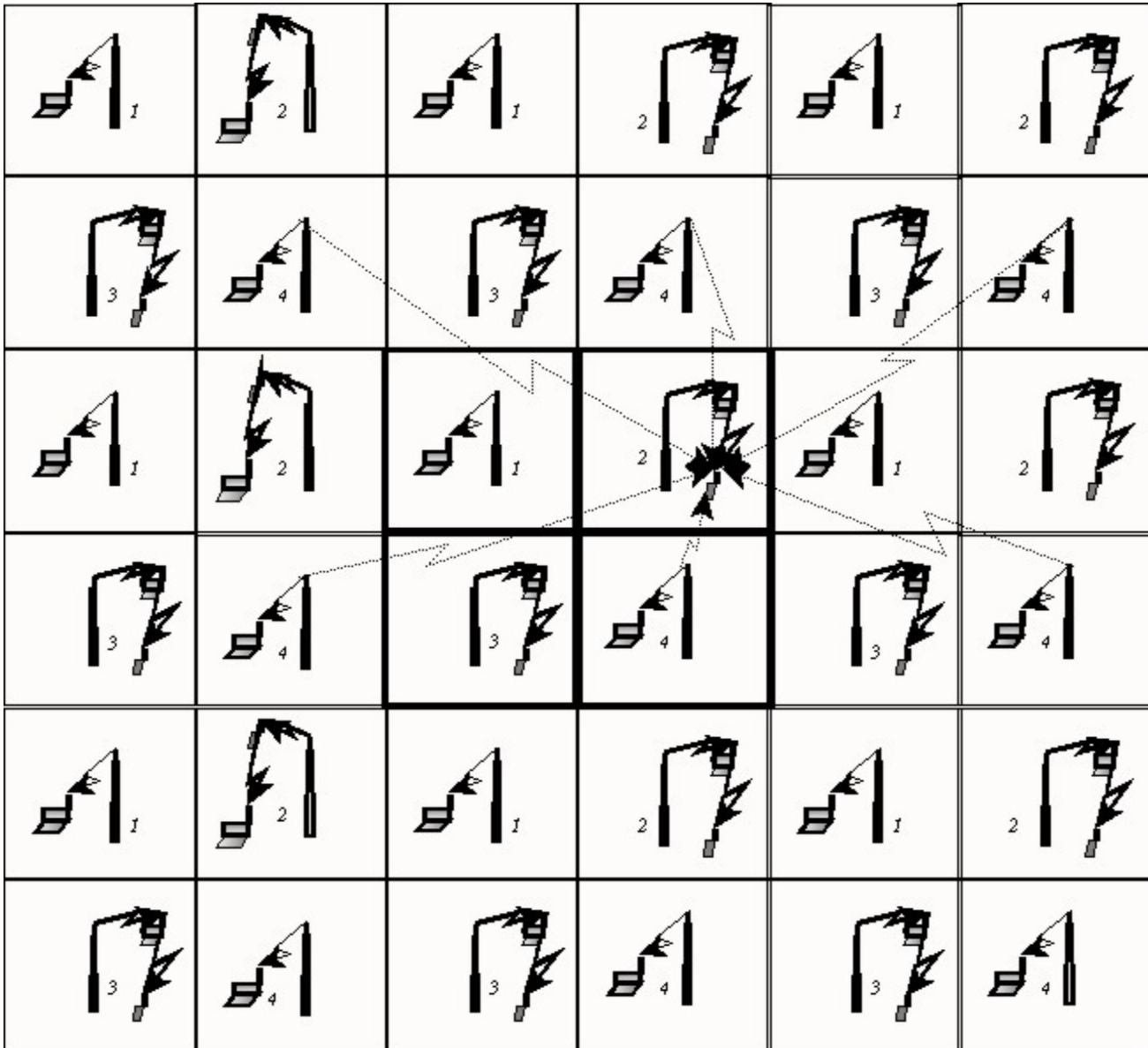

Figure 9. Co-channel interfering links from the base stations, due to adjacent-cell channel reusing for relaying, for a node that is being relayed.

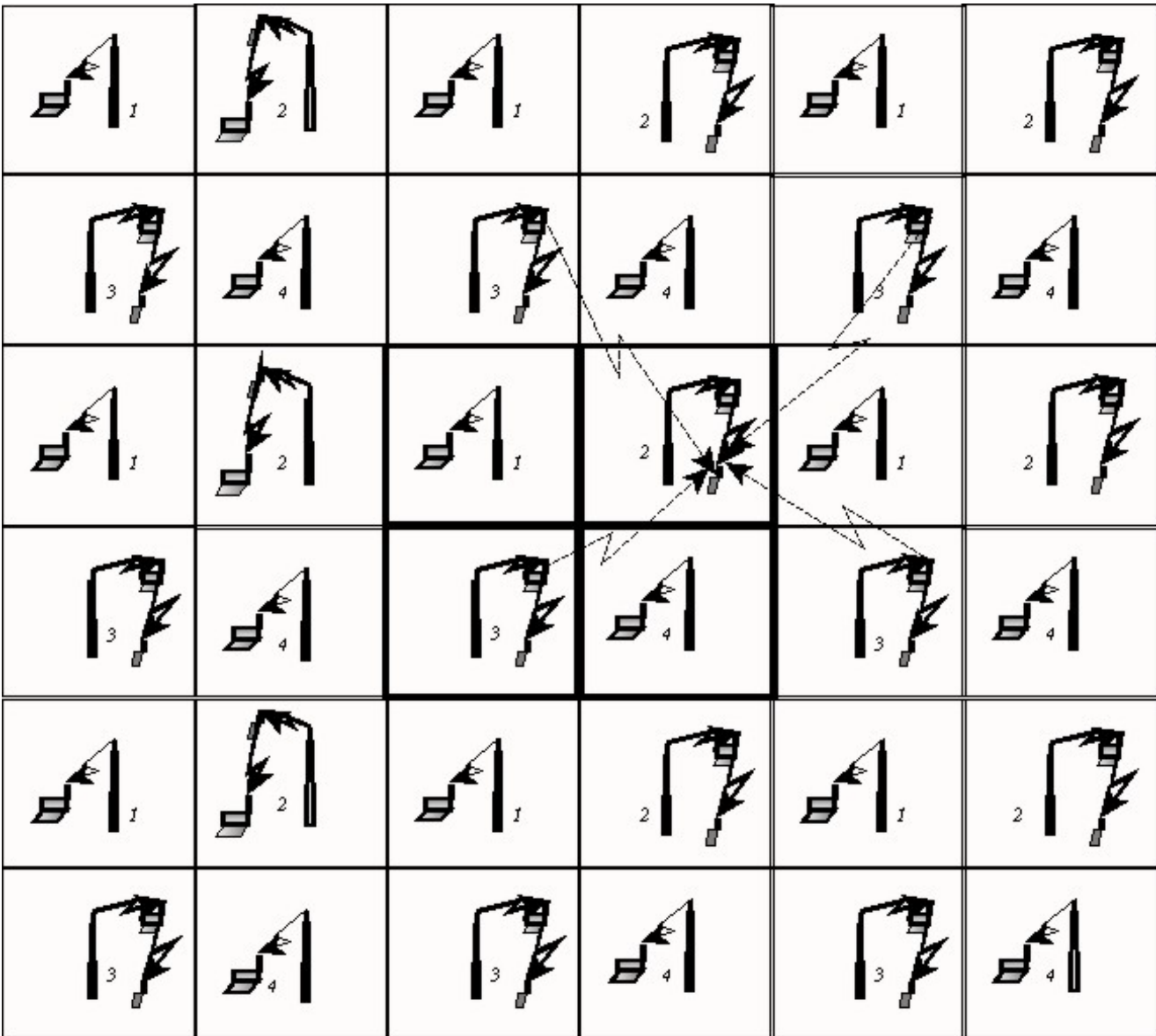

Figure 10. Co-channel interfering links from other relayers located the adjacent cells, due to adjacent-cell channel reusing for relaying, for a node that is being relayed.

Due to the shorter distances, it is expected that the dominant interference will come from the adjacent cells for both – a node that is not being relayed and one that is. Actually, the candidate channels set for relaying purposes do not include those from the corner cells. Thus, only the channels from the cell that is either vertically or horizontally adjacent to the current cell in which the relayed node is located are considered. One further restriction applies to all three channel selection schemes and that is, once a channel from an adjacent cell is selected for reuse in a certain cell, it is tagged, i.e. another relay node from within that same cell cannot be allocated this same channel to reuse simultaneously.

## **CHAPTER 4**

### **SIMULATION MODEL**

This chapter is concerned with the environment parameter and model assumptions needed for establishing the various simulation scenarios described in the previous chapter. Two types of assumption are distinguished here. The first is related to the physical environment and the system parameters, while the second is concerned with the relay model. Following that, a step-by-step outline of the simulation algorithm is provided through flow charts.

#### **4.1 Environment & Parameters Assumptions**

It is envisioned that relaying would be more practical in an urban environment where the user population is dense. If a few sparse coverage holes existed, such that those located in these regions cannot get good coverage from the base station, then there is a high probability that they will be able to be relayed via those whose communications with the base station are good. Therefore, for the model that follows, the parameter assumptions are designed specifically towards those of an urban environment:

- A path-loss propagation exponent:  $n = 4$
- Lognormal shadowing with a standard deviation:  $\sigma = 10$  dB
- Flat Rayleigh fading
- Slow fading
- Simulation area: 6x6 square cells (with wrap-around edges), 4-cell clusters,

cell size varies from 400x400 m to 2x2 km

- RF Carrier = 2.5 GHz, Transmission Bandwidth:  $W = 2$  MHz
- Thermal Noise with a noise figure:  $F = 8$  dB
- Omnidirectional antennas (with a gain of 1) for both the base station and the subscriber terminal
- Power control step size: 2 dB
- Maximum power command update rate: 10
- Maximum base station transmit power per node: 1 W
- Doppler effects are ignored (reasonable for low-speed mobility)
- Single SNR threshold ( $\gamma_t$ ): 10 dB
- The effect of error propagation is ignored
- Downlink scenario only

The reason for assuming wrap-around edges (where the cells on one end become the adjacent cells for those on the opposite end) for the given serving area is to eliminate the edge effect and to simulate the full effects of interference for the system under consideration without having to add many more cells. Thermal noise is also considered at the receiver. The receiver noise power is calculated according to the following formula [24]:

$$N = K_b T_s W F, \quad (20)$$

where  $K_b$  is the Boltzmann's constant ( $1.38 \cdot 10^{-23}$  Joules/Kelvin),  $T_s$  is the system temperature (290 K),  $W$  is the transmission bandwidth, and  $F$  is the noise figure.

As well, only downlink simulation is considered, and tight power control is used for both relaying and non-relaying cases. A "snapshot" power control scheme is used with a step size of 2 dB. Power updates are performed, based on the received SINR reported from the receiver, until

the reported SINR falls between 10 and 12 dB, or until a maximum of 10 updates are reached, which ever one comes first.

According to [28], the above parameters have been shown to offer a good performance for slow fading channels. The additional 2 dB margin to the 10 dB target is needed to offset the additional interference that occurs as a result of relaying. Furthermore, power control performed at the base station is assumed independent of that performed at the relay node, i.e. the power command updates issued by the relay node to the base station are independent of those issued by the relayed node to the relay node.

## 4.2 Model Assumptions

In addition to the above assumptions, the following relaying model assumptions are further necessary:

- Fully loaded cells with continuous traffic
- The number of available channels per cell increases linearly with the number of subscribers
- Subscribers are uniformly distributed within the cell
- Same path-loss propagation model for both: between the base station to the subscriber and between one subscriber to another
- Maximum number of hops: 2
- Maximum number of relayed nodes per relay node: 7
- Adjacent-channel interference is neglected
- Macrodiversity is not considered
- When handing off from a relay node, a mobile node is forced to link up with the base station first if this link becomes good

- Digital form of relaying is used
- Coverage is defined as  $\Pr[\text{SINR} \geq \text{Threshold}] \geq 95\%$  over all nodes in the cell

The assumptions of fully loaded cells and the linear increase in the number of available channels to the number of subscribers per cell allow us to focus on the coverage aspects, rather than the channel capacity aspects, of performance. Any new subscriber is never blocked and will be able to communicate with the base station if it has a good link (as defined above). Normally, in a conventional cellular system, subscribers are given the option to hand off to a neighbor base station offering the strongest signal. This is normally termed macrodiversity. Relaying provides a further option for a subscriber node to improve its SINR. In fact, macrodiversity and relaying are system design choices; for instance, when a relayed node moves to a different location and thus requires a handoff from the current relay link, it now has the option to initiate a new route via relaying or to link up with one of the neighboring base stations.

Up to now there has been very few study on the channel propagation between low height terminals [18]. For the scope of this thesis, we simply assume the same path-loss model for both links: base station-to-mobile terminal and mobile terminal-to-mobile terminal. Hopefully, if and when this relaying concept becomes more prevalent, the channel propagation between mobile terminals in an urban cellular environment will then have been well researched. Furthermore, for practical purposes, the 7-relayed node assumption that a particular relay node can support is considered sufficiently large so that this cap should not have any limiting impact on the performance.

Due to the large bandwidth and noise figure assumptions, a digital form of relaying has been assumed where the signal is demodulated first before being re-modulated and forwarded, as presented in [4]. This assumption is needed in order to eliminate the effects of noise propagation from one hop to the next, and consequently accumulating at the destination [4,23].

In this model, the satisfactory coverage for any individual mobile node is defined as the probability of the received SINR being greater than or equal to the threshold at least 95% of the time. The coverage analysis is carried out only for the subscribers in the innermost cluster (see Fig. 7).

### **4.3 Simulation Algorithm**

For each subscriber density the simulation is started without relaying and after the determination of the portion of subscribers in each cell that do not have satisfactory coverage from the base station (as defined in the previous section), the remaining portion, by definition, makes up the set of candidate relay nodes. Relaying is then incorporated and the simulation continues, with the Rayleigh fading channel changing at different snapshots. Throughout the course of the simulation, after 100 received SINR have been collected for each subscriber, its location position is then changed. In the simulation, when a node changes location, it is forced to link up with the base station in which it resides, first, if that link is good; otherwise, relaying is resorted to. The user coverage evaluation is based on the average of 1000 different subscribers' locations.

The following flow charts offer further details of the simulation process. Fig. 11 depicts the simulation process, Fig. 12 entails the scenario where relaying is incorporated, and Fig. 13 depicts the channel selection process based on the Smart selection scheme (since it is the most complicated scheme, we chose to present it in a more detailed format):

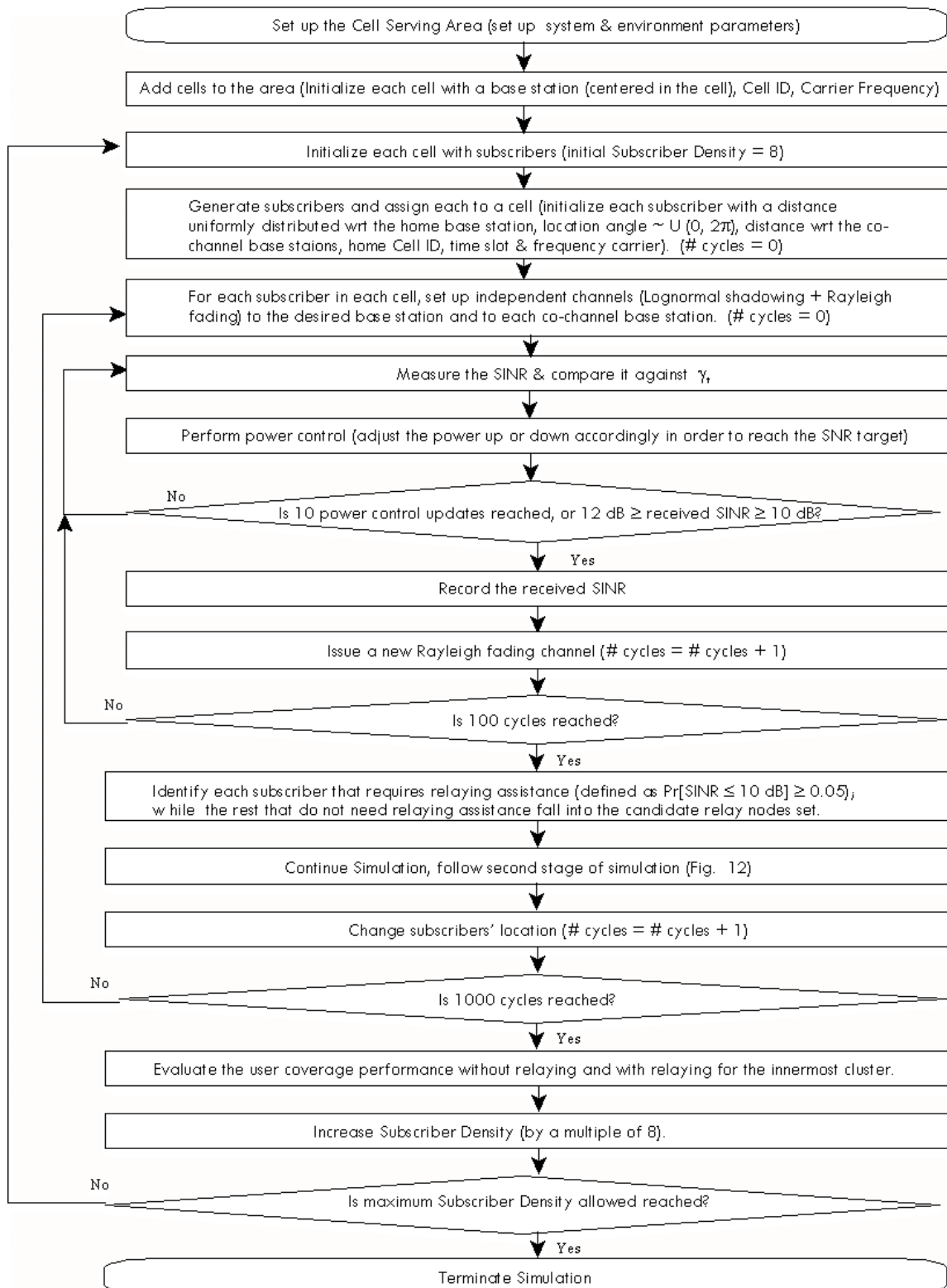

**Figure 11. Flow chart of the overall simulation process.**

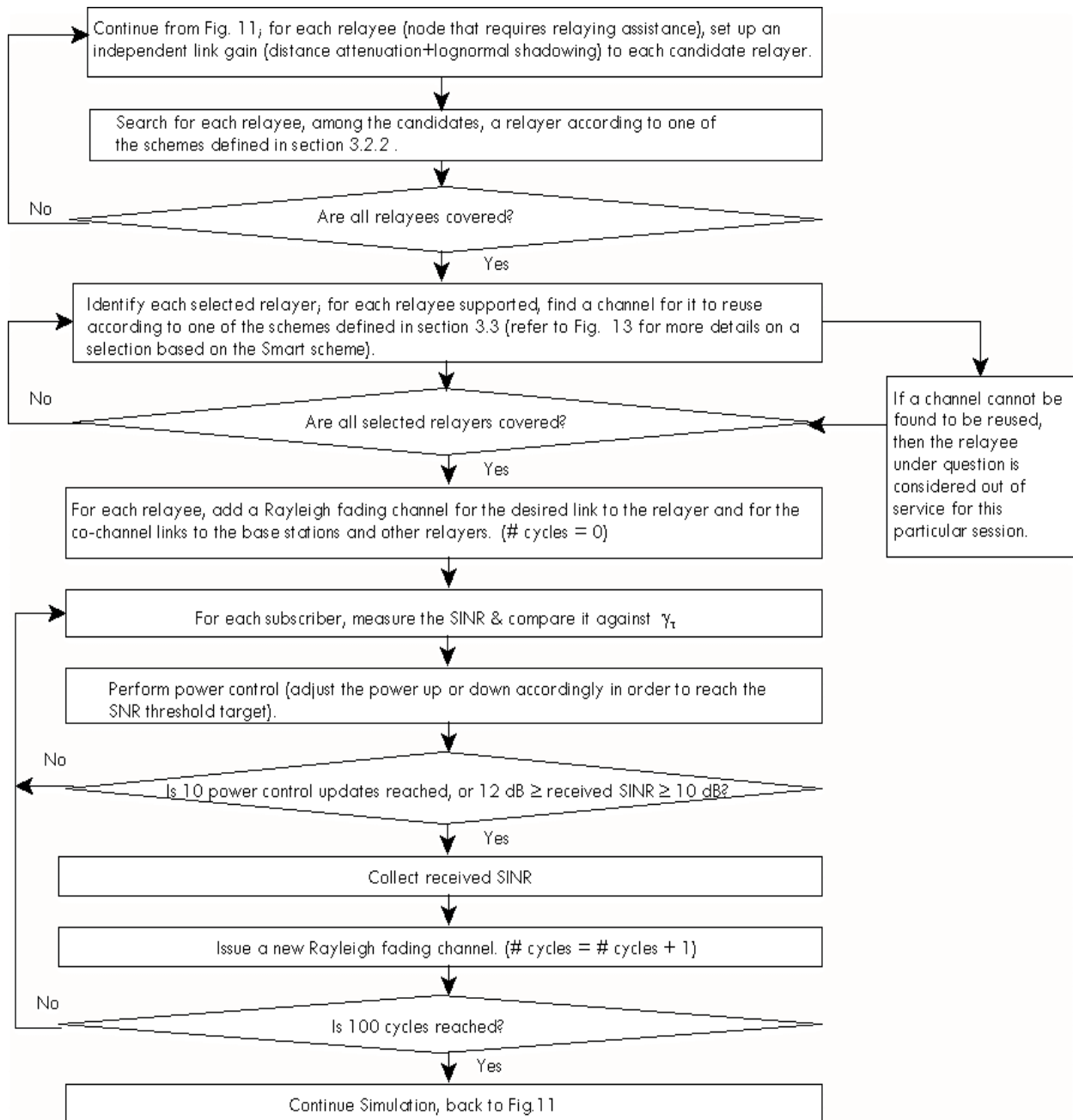

**Figure 12. Flow chart of the simulation scenario with relaying incorporated.**

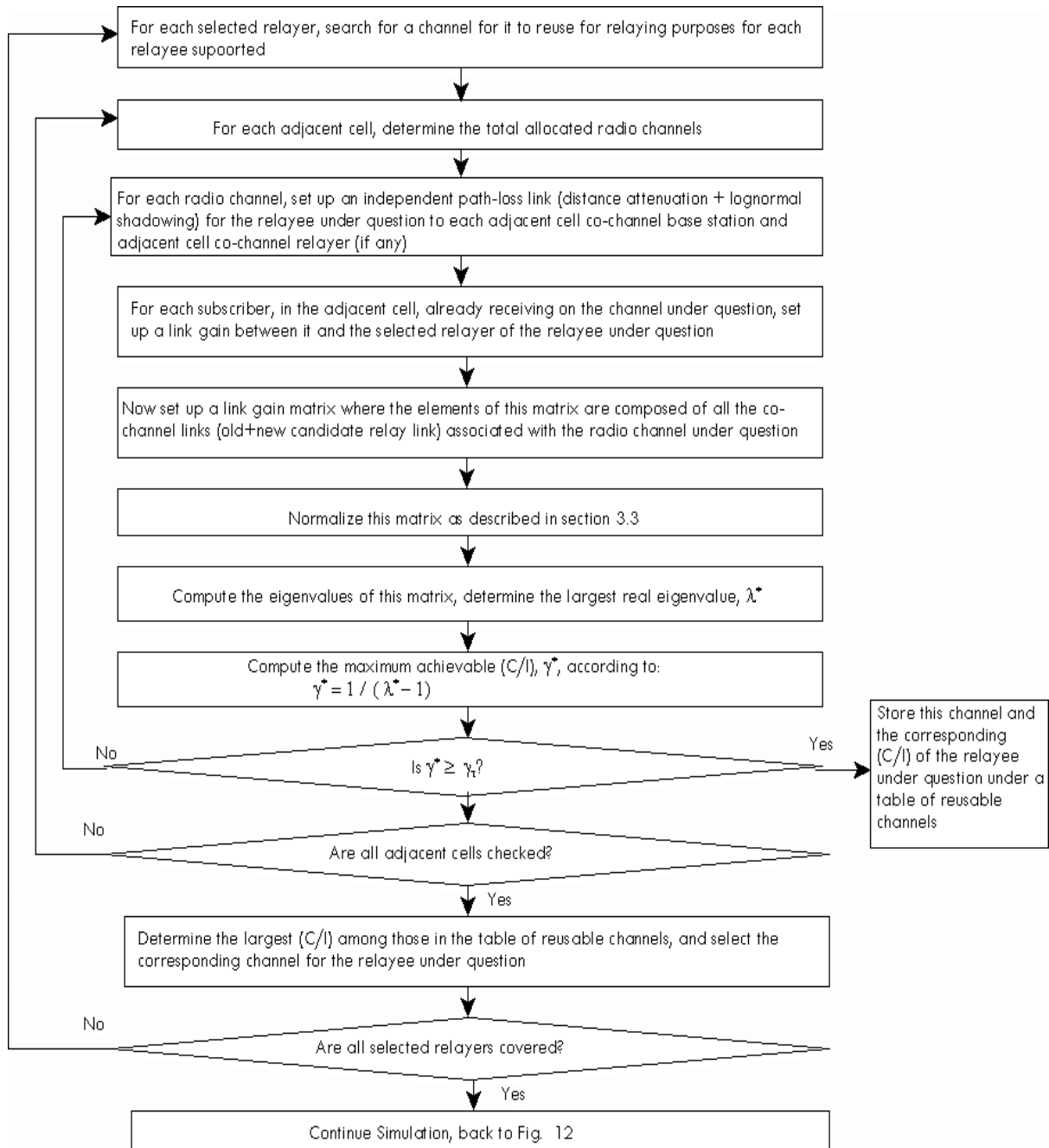

**Figure 13. Adjacent-cell channel reuse scheme based on the Smart channel selection.**

## CHAPTER 5

### SIMULATION RESULTS

In this chapter we present the simulation results for the different scenarios established in the previous chapters. The objectives of these simulations are to determine the sensitivity of the system coverage performance to the different combinations of relay node and channel selection schemes. First, we begin with a system with a large cell size, namely 2x2 km, then we reduce the cell size to 1x1 km, and finally to 400x400 m. With only 2-hop relaying and omnidirectional antenna consideration, whereby the *EIRP* (Effective Isotropic Radiated Power) is limited in range, relaying may not be as effective in a large-cell system such as macrocells. Furthermore, through the method of adaptive modulation we attempt to verify further benefits gained from relaying by using, in addition to the system coverage, the average node throughput, as another performance measure.

#### 5.1 Performance Impact for a Noise-Limited System

Figs. 14 and 15 below show the results for the case where the cell size is 2x2 km; the relay node selection scheme is based on the Smart selection; the channel selection scheme is based on the Semi-Smart selection, and the relay node maximum transmit power is a parameter that ranges from 100 mW up to 1 W. The difference between the two figures is that Fig. 14 is without power control, while Fig.15 is with power control. Referring to Fig. 15, it can be observed that when the user coverage is low when relaying is not considered, with relaying the performance only improves gradually. For instance, at the subscriber density of 64, the coverage

increases from approximately 38% to 58% with relaying and the maximum relay node transmit power of 100 mW and 1 W respectively. From another perspective, at the maximum relay node transmit power of 1W the coverage increases from 30% to 58% as the subscriber density per cell increases from 8 to 64. This is the case of a noise-limited system where the performance increases gradually with increasing relay node maximum power. Obviously, the reason for this poor performance is due to the use of omnidirectional antennas and as well a high path-loss exponent. For instance, the coverage range of 1 W power using omnidirectional antennas is approximately 200 m for outdoors [35]. Hence, the performance improvement is expected to be better if directional antennas are used, in which case the *EIRP*, defined as:

$$EIRP = P_t G_t, \quad (21)$$

would be much stronger.

As the cell size is reduced to 1x1 km, as shown in Figs. 16 and 17, while keeping everything else the same, we see a larger improvement from relaying. Again, the difference between the two figures is that Fig. 16 is without power control, while Fig. 17 is with power control. Here, it can be observed that the performance improvement with power control is consistently superior to the case with no power control (i.e. for a 1 W maximum relay node transmit power and a subscriber density of 80, the coverage improvement due to relaying but without power control is only approximately 78%, compared to 94% with power control). Referring to Fig. 17, two observations are noted: one is that the coverage performance without relaying is higher than the previous case (approximately 45% user coverage here versus 24.5% in the case of 2x2 km cell size) – which means there are more potential relay nodes available, and subsequently, the coverage improvement with relaying is significantly higher compared to the previous case.

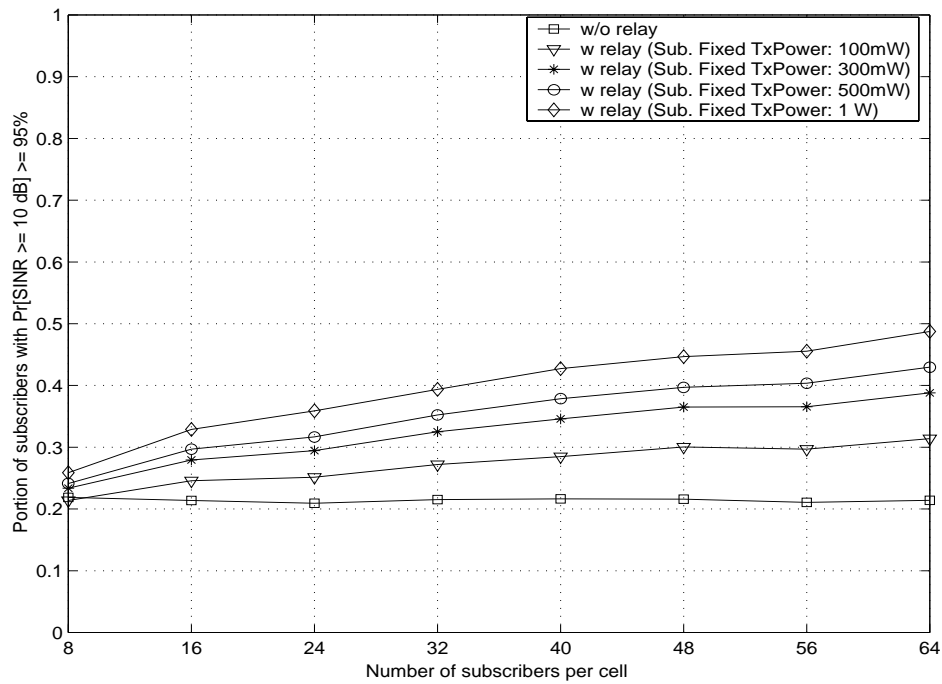

**Figure 14. User Coverage vs. Number of users per cell (for 2x2 km cell size, No Power Control, Smart Relay Node Selection, Semi-Smart Channel Selection).**

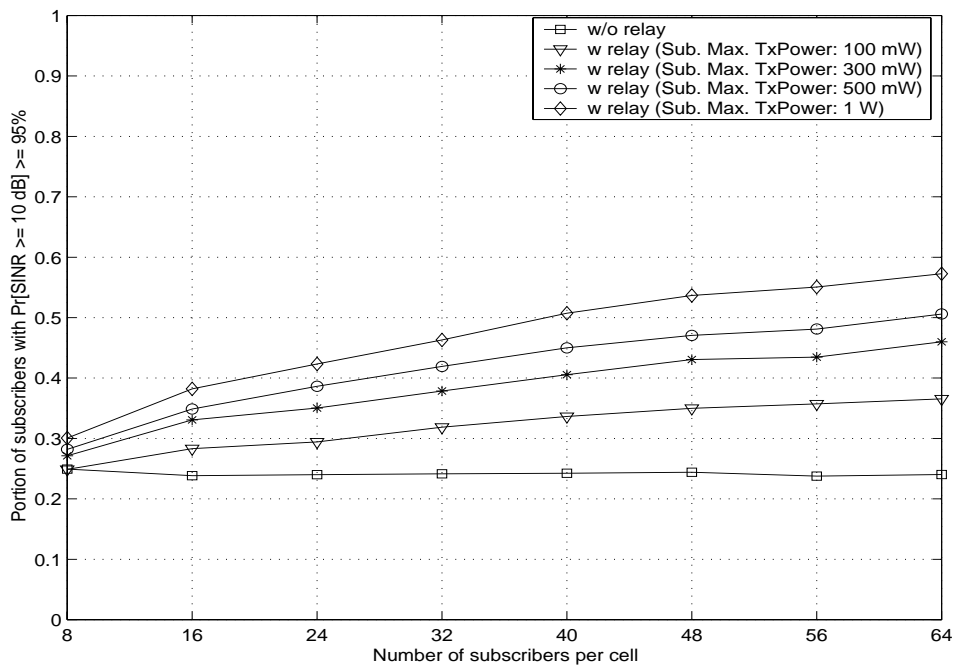

**Figure 15. User Coverage vs. Number of users per cell (for 2x2 km cell size, Power Control, Smart Relay Node selection, Semi-Smart Channel Selection).**

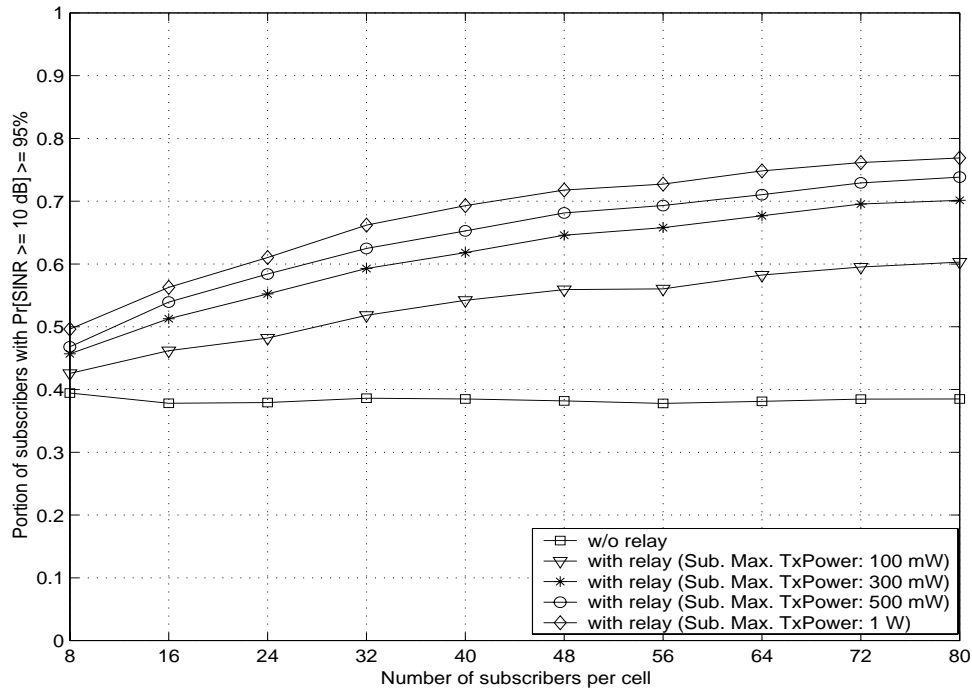

**Figure 16. User Coverage vs. Number of users per cell (for 1x1 km cell size, No Power Control, Smart Relay Node Selection, Semi-Smart Channel Selection).**

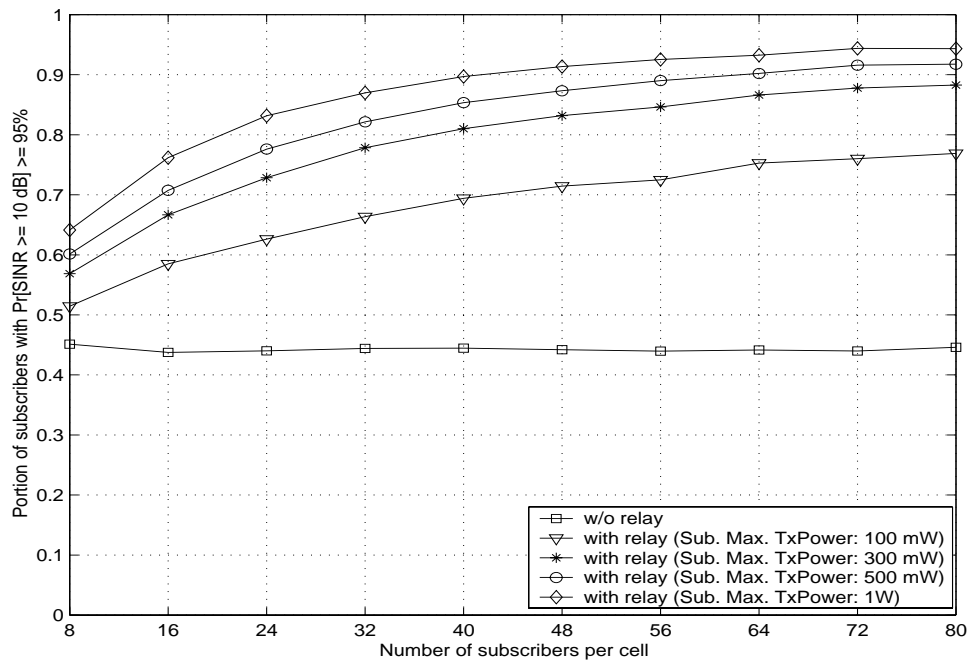

**Figure 17. User Coverage vs. Number of users per cell (for 1x1 km cell size, Power Control, Smart Relay Node Selection, Semi-Smart Channel Selection).**

## 5.2 Performance Impact for an Interference-Limited System

As the cell size is further reduced to 400x400 m, as shown in Figs. 18 and 19 below, we continue to see a further improvement. Fig. 18 is without power control, while Fig. 19 is with power control. Here, a few interesting observations are noted. Firstly, the impact of power control here is much more pronounced than in the cases of the larger cell size, as this can be witnessed by the significant difference in performance improvement between Fig. 18 and 19 (i.e. at a maximum relay node transmit power of 100 mW and a subscriber density of 64, the coverage increase due to relaying here is approximately 27% versus 13% for the 2x2 km cell size case, Fig. 15). Secondly, the number of subscribers per cell does not have to be high before we witness a significant coverage improvement due to relaying, as this can be seen by the plots corresponding to the cases where the number of subscribers per cell is at 16 to 24, as shown in Fig. 19. Thirdly, this corresponds to an interference-limited case where a significant improvement is observed at a very low relay node maximum power level, as low as 20 mW according to Fig. 19, and as the transmit power is increased, we do not observe a higher performance improvement. In fact, the performance starts to saturate beyond the 100 mW maximum transmit power level, as the number of subscribers increases (i.e. the coverage improvement saturates at approximately 98% as the maximum relay node transmit power exceeds 100 mW and the subscriber density per cell exceeds 48 subscribers).

The fluctuation observed in Fig. 18 for the case of no relaying (bottom curve) is due to the statistical variations from the simulation. For instance, since the subscribers are assumed uniformly distributed within the cell, the performance without relaying should be a straight line

as the subscriber density per cell increases. As such, a statistical analysis can be performed to obtain a 95% confidence interval for the coverage performance for this case. In general, for a collection of data samples  $\{Y_1, \dots, Y_n\}$  of size  $n$ , the sample mean or the point estimator,  $\hat{\rho}$ , of  $\rho$  based on these data samples is given by [2]:

$$\hat{\rho} = \frac{1}{n} \sum_{i=1}^n Y_i \quad (22)$$

If  $E\{\hat{\rho}\} = \rho$ , then  $\hat{\rho}$  is said to be an unbiased estimator of  $\rho$ . Though in general,

$$E\{\hat{\rho}\} = \hat{\rho} + b, \quad (23)$$

where  $b$  is the bias. In order to obtain an interval estimation, we need to determine the estimated variance of  $\hat{\rho}$ . Let  $\sigma^2(\hat{\rho})$  represents the true variance of  $\hat{\rho}$ , and let  $\hat{\sigma}^2(\hat{\rho})$  represent an estimator of  $\sigma^2(\hat{\rho})$  based on the data samples  $\{Y_1, \dots, Y_n\}$ . In general,

$$E\{\hat{\sigma}^2(\hat{\rho})\} = B \sigma^2(\hat{\rho}), \quad (24)$$

where  $B$  is called the bias in the variance estimator if  $B \neq 1$ , otherwise it is called an unbiased estimator of the variance  $\sigma^2(\hat{\rho})$ . If  $\hat{\sigma}^2(\hat{\rho})$  is approximately unbiased, then under general conditions the statistic:

$$t = \frac{\hat{\rho} - \rho}{\hat{\sigma}(\hat{\rho})} \quad (25)$$

is approximately  $t$  distributed (follows a student distribution) with some number of degrees of freedom,  $f$  [2]. An approximate  $100(1 - \alpha)\%$  confidence interval for  $\rho$  can be obtained by:

$$\hat{\rho} \pm t_{\alpha/2, f} \hat{\sigma}(\hat{\rho}), \text{ or equivalently: } \hat{\rho} - t_{\alpha/2, f} \hat{\sigma}(\hat{\rho}) \leq \rho \leq \hat{\rho} + t_{\alpha/2, f} \hat{\sigma}(\hat{\rho}),$$

where  $t_{\alpha, f}$  is the 100(1 -  $\alpha$ ) percentage point of a  $t$  distribution with  $f$  degree of freedom, which can be obtained from table A.5 in [2].

If  $\{Y_1, \dots, Y_n\}$  are statistically independent observations, then an unbiased estimate of the  $\sigma^2(\hat{\rho})$  or the sample variance,  $S^2$ , is obtained as follows:

$$S^2 = \sum_{i=1}^n \frac{(Y_i - \hat{\rho})^2}{n-1} \quad (26)$$

Since the true variance of  $\hat{\rho}$  is:  $\sigma^2(\hat{\rho}) = \frac{\sigma^2}{n}$ , the unbiased estimator of  $\sigma^2(\hat{\rho})$  with  $f$  (where  $f = n-1$ ) degrees of freedom is given by:

$$\hat{\sigma}^2(\hat{\rho}) = \frac{S^2}{n}, \quad (27)$$

The standard error,  $\sigma(\hat{\rho})$ , of the point estimator  $\hat{\rho}$  is therefore given by:

$$\hat{\sigma}(\hat{\rho}) = \frac{S}{\sqrt{n}} \quad (28)$$

Referring to Fig. 18, for the case of no relaying (bottom curve), each subscriber density can be treated as an independent observation (i.e. each is simulated using a different random number generator), where  $n$  the number of observations is 8 and  $f$  the degrees of freedom is 7 (8-1). The coverage performance for each subscriber density point (which corresponds to Fig. 18 for the case of no relaying) is provided by the table below.

	<i>Subscriber Density per cell</i>							
	8	16	24	32	40	48	56	64
Cov.	0.54	0.518437	0.513958	0.52375	0.51525	0.51656	0.51714	0.51656

**Table 1. Coverage performance for Fig. 18 corresponding to the case of no relaying at each corresponding subscriber density level per cell.**

Let  $\hat{C}$  denote the point estimator for the coverage performance without relaying, which can be computed as follows:

$$\hat{C} = \frac{0.54 + 0.518437 + 0.513958 + 0.52375 + 0.51525 + 0.516563 + 0.517143 + 0.516563}{8} = 0.5202$$

Thus, the sample variance of  $\hat{C}$  can be computed as follows:

$$\hat{\sigma}^2(\hat{C}) = \frac{(0.54 - 0.5202)^2 + \dots + (0.516563 - 0.5202)^2}{7(8)} = 0.000009052$$

While the standard error is obtained from  $\hat{\sigma}^2(\hat{C})$  by taking the square root:

$$\hat{\sigma}(\hat{C}) = 0.003008.$$

Therefore, the 95% confidence interval for the coverage performance without relaying (where

$t_{\alpha/2, f} = t_{0.025, 7} = 2.36$ , which is obtained from table A.5 in [2]),  $\hat{C} \pm t_{0.025, 7} \hat{\sigma}(\hat{C})$ , is:

$0.513128 \leq C \leq 0.527288$ . In other words, with 95% confidence, the coverage without relaying in Fig. 18 lies between 51.3% and 52.7%. Fig. 20 offers a different perspective on the coverage performance due to relaying; here it is plotted against the maximum relay node transmit power. It can be observed that at a lower subscriber density per cell (bottom curve of Fig. 20, which corresponds to a subscriber density per cell of 8), the dynamic range of relay node transmit

power is 20-1000 mW before the coverage improvement starts to saturate. Meanwhile, at a higher subscriber density per cell (i.e. 64) this range reduces to 20-100 mW. This is mainly due to the potential increase in the interference, since the average distances between adjacent cell subscribers are shorter at the higher subscriber density. Therefore, power control helps minimize this additional interference.

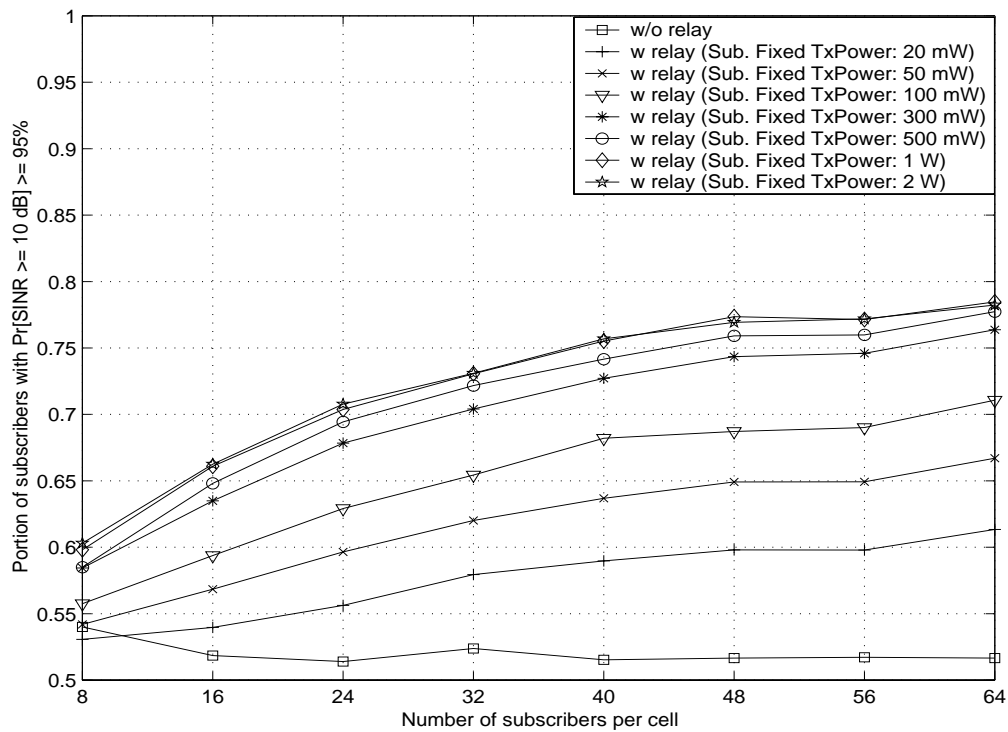

**Figure 18. User Coverage vs. Number of users per cell (for 400x400 m cell size, No Power Control, Smart Relay Node Selection, Semi-Smart Channel Selection).**

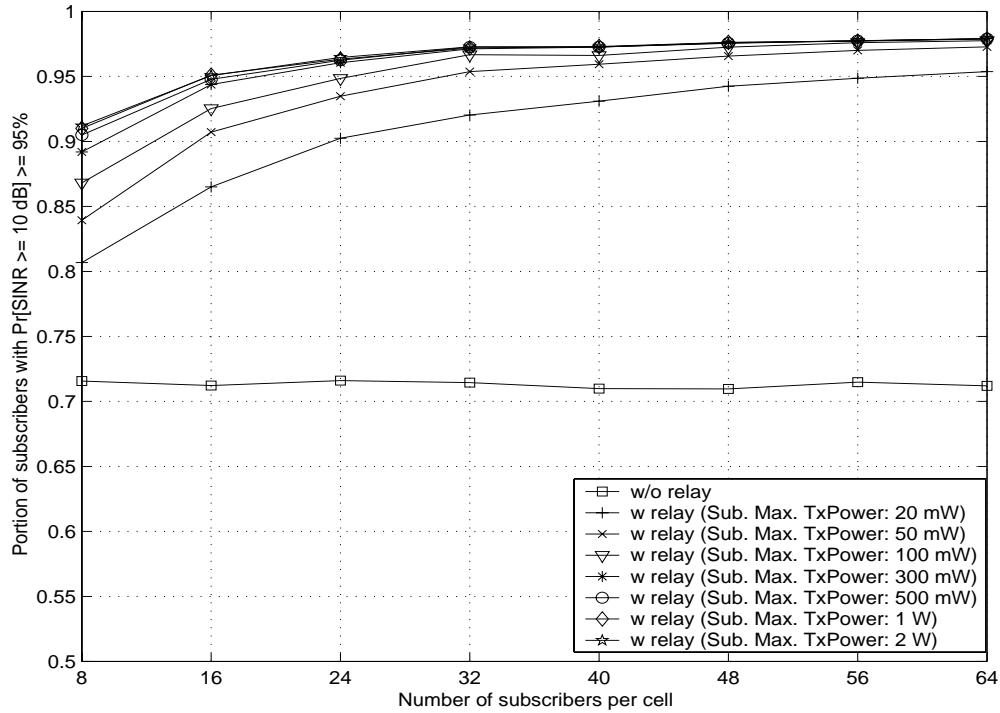

**Figure 19. User Coverage vs. Number of users per cell (for 400x400 m cell size, Power Control, Smart Relay Node Selection, Semi-Smart Channel Selection).**

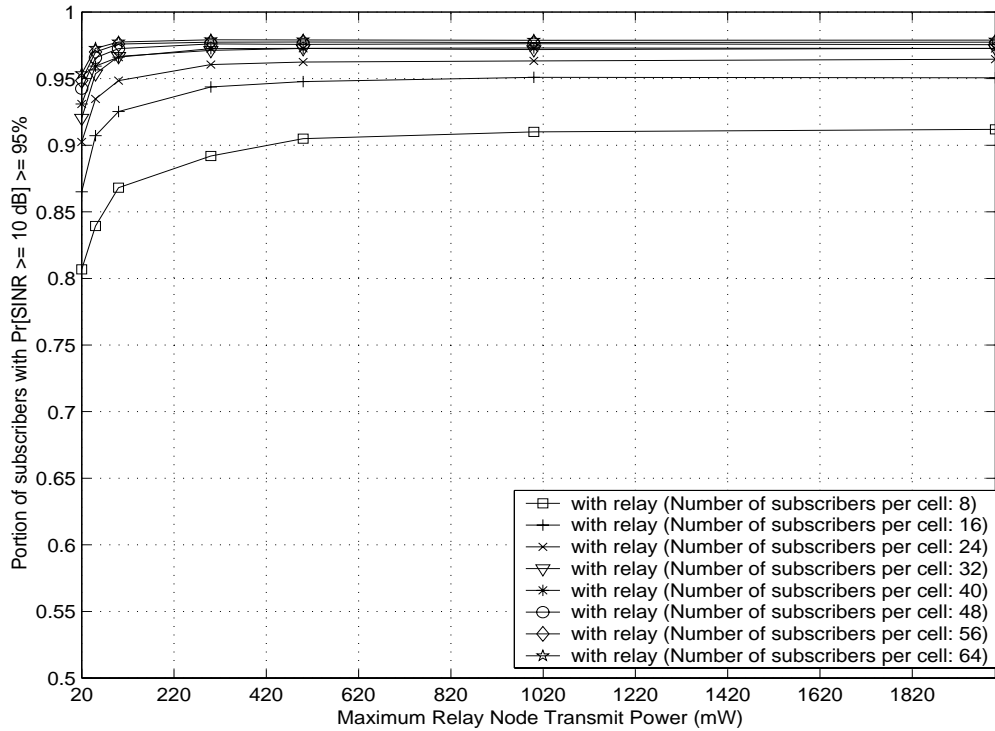

**Figure 20. User Coverage vs. Maximum Relay Node Transmit Power (for 400x400 m cell size, Power Control, Smart Relay Node Selection, Semi-Smart Channel Selection).**

### **5.3 Impact of Relay Node/Path Selection on Coverage**

In this section we present the results for the impact of relay node/path selection schemes on the coverage first basing the selection metric on the geographic distance, and then on the path-loss. Since the performance results for the smaller cell size are more interesting, the rest of the simulation scenarios that follow apply to a system with a cell size of 400x400 m only.

#### ***5.3.1 Selection based on Geographic Distance***

The two figures below, Figs. 21-22, have the following in common: the cell size is 400x400 m, power control, and the channel selection scheme is the Semi-Smart selection. The only difference concerns the relay node/path selection. Fig. 21 corresponds to the case where the selection is based on the shortest path, while Fig. 22 is based on the shortest relay hop. As can be observed the performance improvement with the latter is better than the former (an approximate 30% coverage increase due to the latter compared to only 6% increase due to the former, when relaying is used, the subscriber density is 64, and the maximum relay node transmit power is 20 mW). Therefore, it is more efficient to select a relay path based on the shortest distance between the candidate relay node and the node in need of relaying assistance, rather than the shortest overall path.

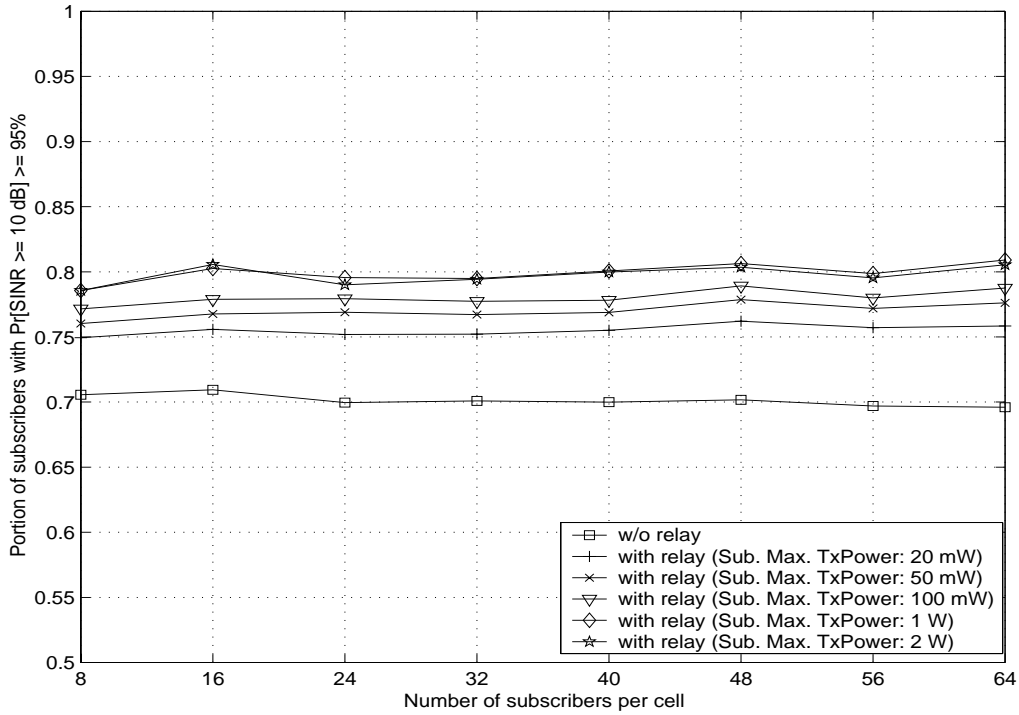

**Figure 21. User Coverage vs. Number of users per cell (for 400x400 m cell size, Power Control, Shortest Path Selection, Semi-Smart Channel Selection).**

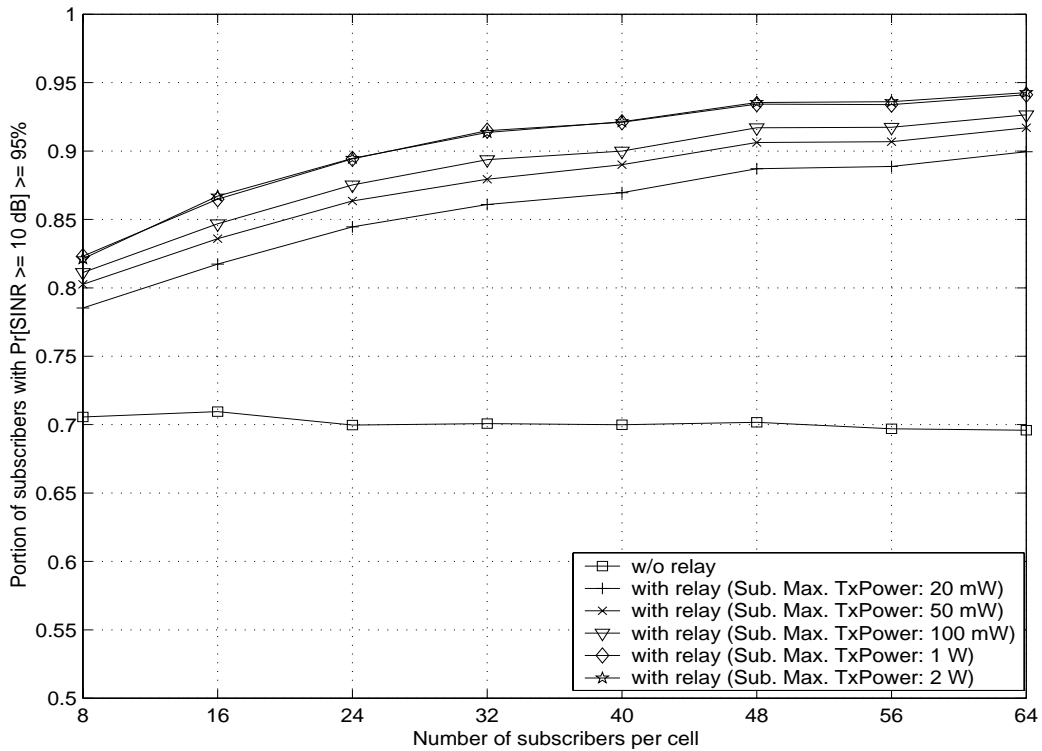

**Figure 22. User Coverage vs. Number of users per cell (for 400x400 m cell size, Power Control, Shortest Relay Hop Selection, Semi-Smart Channel Selection).**

### 5.3.2 Selection based on Path-loss

The next 2 figures, Figs. 23 and 24, have the following in common: the cell size is 400x400 m, power control, and the channel selection scheme is the Semi-Smart selection. The only difference concerns the the maximum relay node transmit power. Fig. 23 corresponds to 20 mW, while Fig. 24 corresponds to 1 W maximum relay node transmit power. In Fig. 23, the curve with the plus signs corresponds to Random selection where it can be observed that very little improvement is obtained through relaying (i.e. the coverage increases by only 2% irrespective of the subscriber density per cell). This result shows how sensitive the system performance is to the relay node/path selection. This situation could occur where the majority of nodes that require relaying assistance made a wrong relay node selection, due to reasons such as poor channel estimations or biased selection decisions affected by the fast Rayleigh fading channel, and as a result, a higher transmitted power than necessary is required to reach this relayed node by each corresponding selected relay node. As such, if power control was not employed in this case, we would expect to see a performance degradation due to increased interference as a result of relaying.

The curves with the x marks and the diamonds of Fig. 23 correspond to Semi-Smart and Smart selection respectively. With careful observation, we can observe that the Semi-Smart scheme offers a slightly better improvement than the Smart scheme (approximately 97% versus 95% at the subscriber density of 64); while, at the higher power of 1 W (Fig. 24), the Smart scheme seems to be slightly superior to the Semi-Smart scheme. The reason for this was explained in section 3.2.2 – namely, whenever the relay node has a power constraint (such as in the 20 mW case), the link between it and the relayed node tends to dictate the quality of service

at the relayed node. Since the Smart selection scheme does not always try to choose the best link among those between the candidate relay node to the relayed node, it is therefore inferior to the Semi-Smart scheme.

Further, Fig. 25 presents the frequency of relay node type (i.e. those supporting 1, 2, 3, 4, 5, 6, or 7 relayed nodes) normalized by the subscriber density. This result is extracted from the simulation shown in Fig. 23 for the Semi-Smart relay node selection scheme. It is presented in this manner in order to reflect the result shown in Fig. 23. As an example, at a subscriber density of 24, the frequency of occurrence (normalized by the subscriber density) of a one-to-one relay node type is 0.165, that of a one-to-two type is 0.03, and that of a one-to-three type is 0.0036, while the rest is approximately 0. Thus, in order to obtain the total number of users relayed, we must perform the following:

$$(0.165*24*1) + (0.03*24*2) + (0.0036*24*3) = 5.6592,$$

which coincide with the result shown in Fig. 23:  $(0.9256 - 0.70)*24 = 5.4144$ , when rounded down to the nearest integer.

As can be observed, the most frequent occurrence is a one-to-one type (i.e. 1 relay node supporting 1 relayed node), while the one-to-four type and above is rare. This provides a supporting evidence for our claim that the 7-relayed node per relay node cap does not have a limiting impact on performance improvement. Nonetheless, it should be noted that this is a function of the subscriber distribution, which in our model we have assumed a uniform distribution.

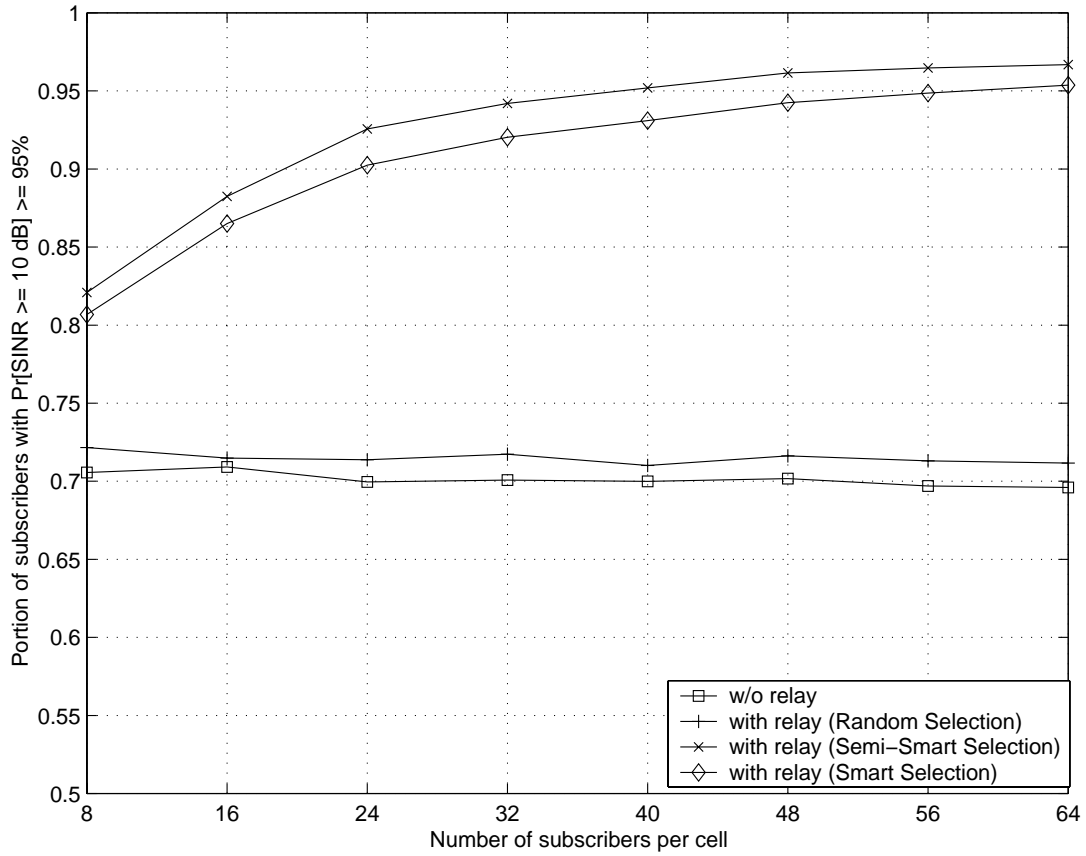

**Figure 23. User Coverage vs. Number of users per cell (for 400x400 m cell size, Maximum Relay Node TxPower: 20 mW, Power Control, Semi-Smart Channel Selection).**

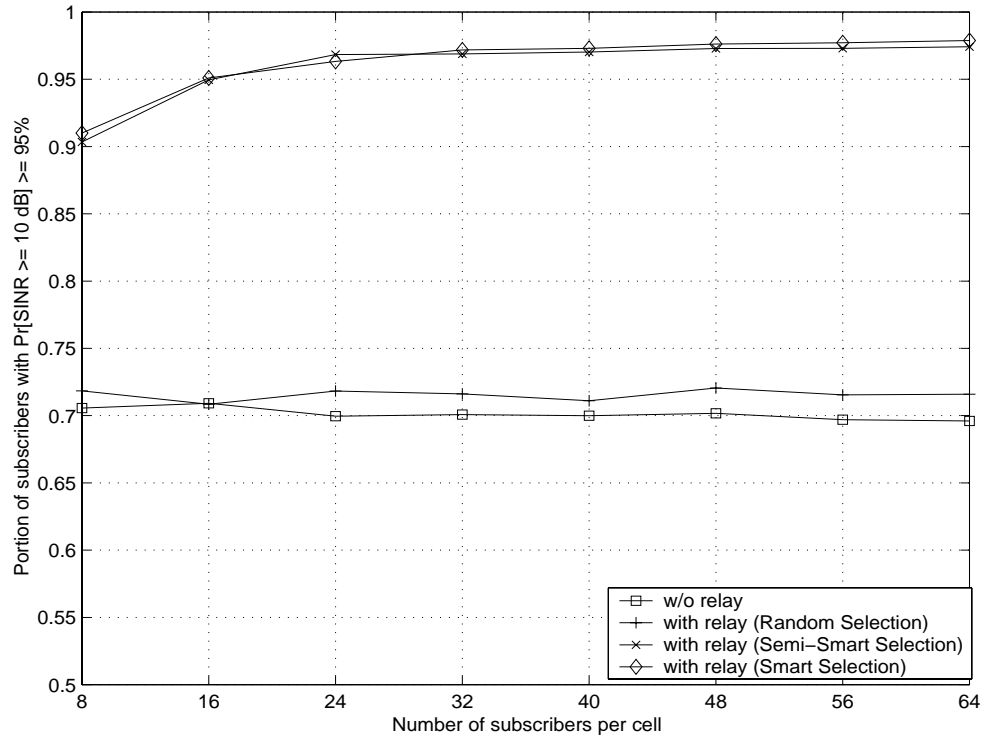

**Figure 24. User Coverage vs. Number of users per cell (for 400x400 m cell size, Maximum Relay Node TxPower: 1 W, Power Control, Semi-Smart Channel Selection).**

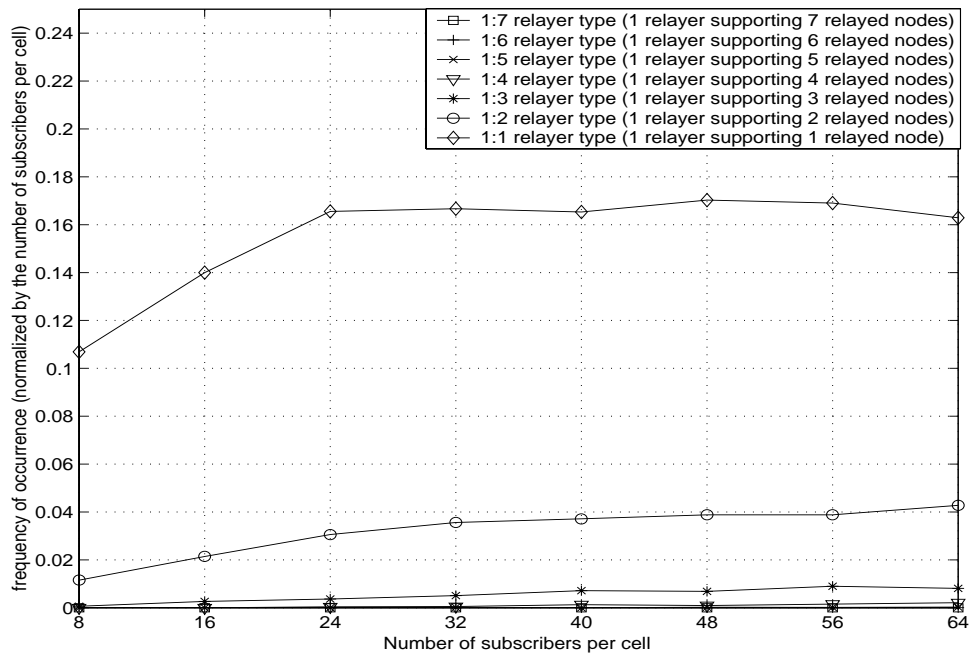
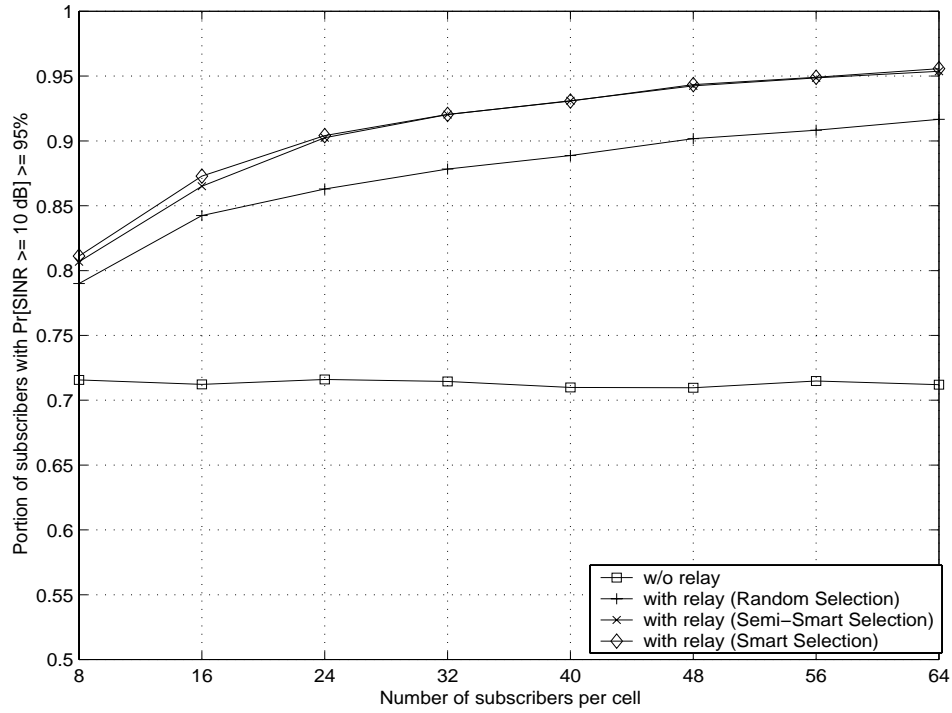

**Figure 25. Frequency of Relay Type (normalized by the subscriber density) vs. Number of users per cell (Corresponds to Fig. 23 for Semi-Smart Relay Node Selection Scheme).**

## 5.4 Impact of Channel Selection on Coverage

In the following figures, we adjust the relay node selection scheme to the Smart selection, while changing the channel selection scheme in order to determine the impact of channel selection on performance improvement. Fig. 26 corresponds to 20 mW, while Fig. 27 corresponds to 1 W maximum relay node transmit power. At the 20 mW level, no performance difference is observed between the Semi-Smart and Smart selection (approximately 95% coverage versus 92% at a subscriber density of 64), although they both outperform the Random selection.

At the 1 W level, the Smart scheme offers a slightly better performance than the Semi-Smart and Random selection schemes (approximately 97% compared to 96% and 90%, respectively, at a subscriber density of 64). The main reason for this is due to the fact that the Smart scheme takes into account the potential increase in interference and avoids reusing a channel that would create excessive interference to other already established links.



**Figure 26. User Coverage vs. Number of users per cell (for 400x400 m cell size, Maximum Relay Node TxPower: 20 mW, Power Control, Smart Relay Node Selection).**

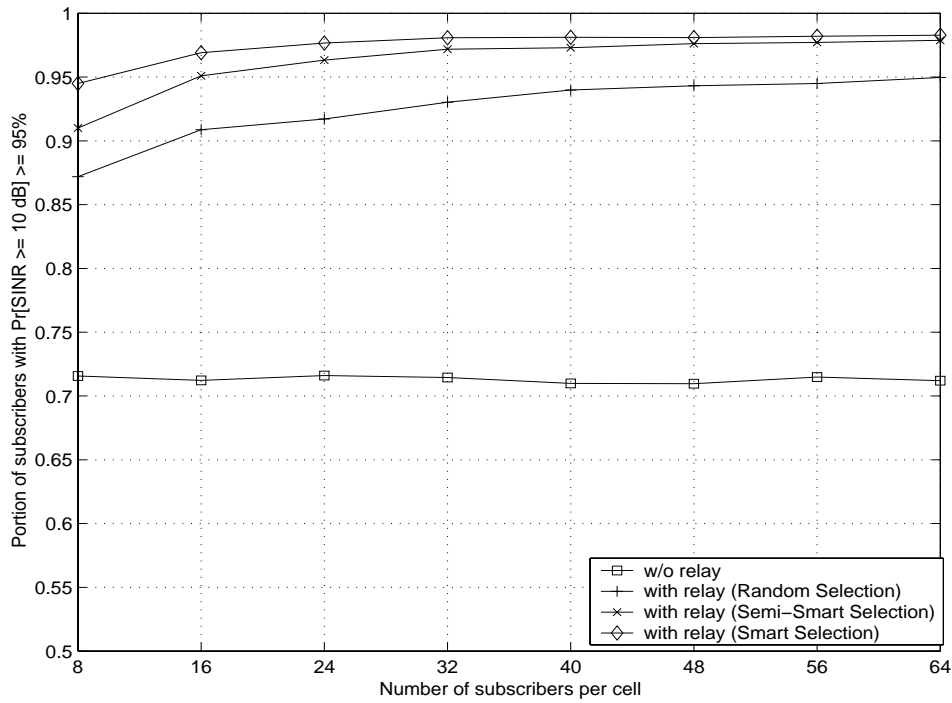
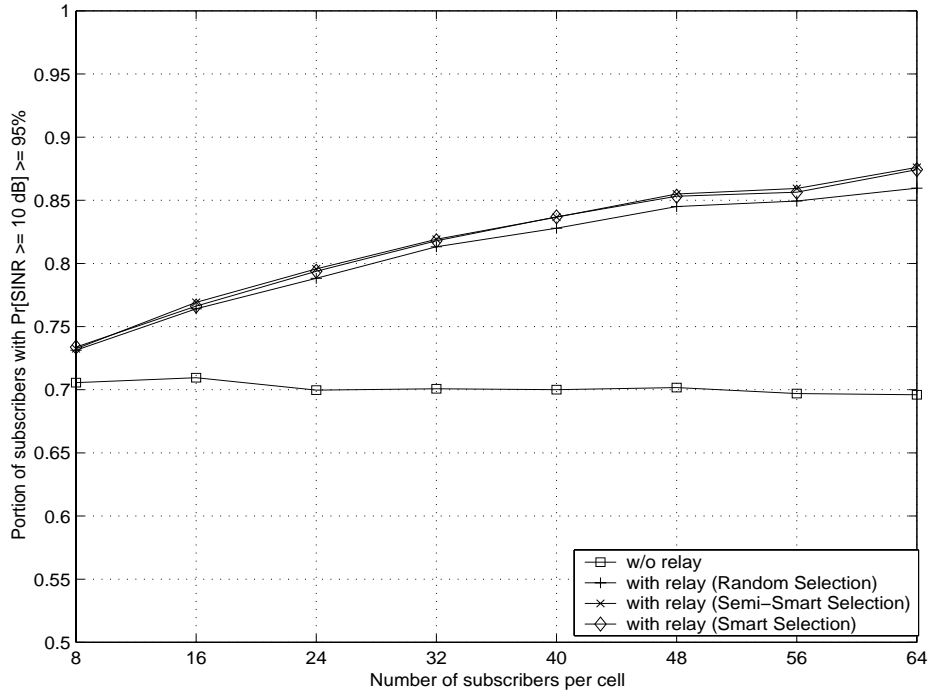

**Figure 27. User Coverage vs. Number of users per cell (for 400x400 m cell size, Maximum Relay Node TxPower: 1 W, Power Control, Smart Relay Node Selection).**

The results seen thus far pertain to a scenario where we have assumed that a given relayed node can always be affiliated with every other candidate relay node within the cell. However, in a real system, depending on the terrain of the system under consideration, the above assumption may not always be accurate. Thus, we next consider a scenario where we restrict the candidate relay nodes set to those that fall within a 50 m circular radius of the relayed node.

### **5.5 Impact of Relay Node/Path Selection on Coverage (smaller Candidate Relay Node Set)**

For the 2 figures below, Figs. 28-29, the candidate relay nodes set is reduced to a smaller set (whereby any node that falls within a sweep radius of 50 m of the relayed node is considered a candidate), while the different relay node selection schemes are applied to this smaller set. Figs. 28 and 29 correspond to a 20 mW and 1 W maximum relay node transmit power respectively. As can be observed, in either maximum power level there is practically no difference in the performance improvement among the three relay node selection schemes. The reason for this is because any candidate relay node that falls within the above requirement must have more or less the same channel conditions to the relayed node under question (perhaps almost a clear LOS). So the relay node selection scheme is not so crucial. However, it is obvious that with a limited candidate relay node set, the maximum achievable improvement is correspondingly reduced (only a coverage increase of approximately 17% here compared to 27% in the case of no restriction on the candidate relay node set, as seen in Fig. 23 with a subscriber density of 64 and the maximum relay node transmit power of 20 mW) since, in some cases, some nodes in need of relaying assistance cannot find a relay node.



**Figure 28. User Coverage vs. Number of users per cell (for 400x400 m cell size, Maximum Relay Node TxPower: 20 mW, Power Control, Semi-Smart Channel Selection).**

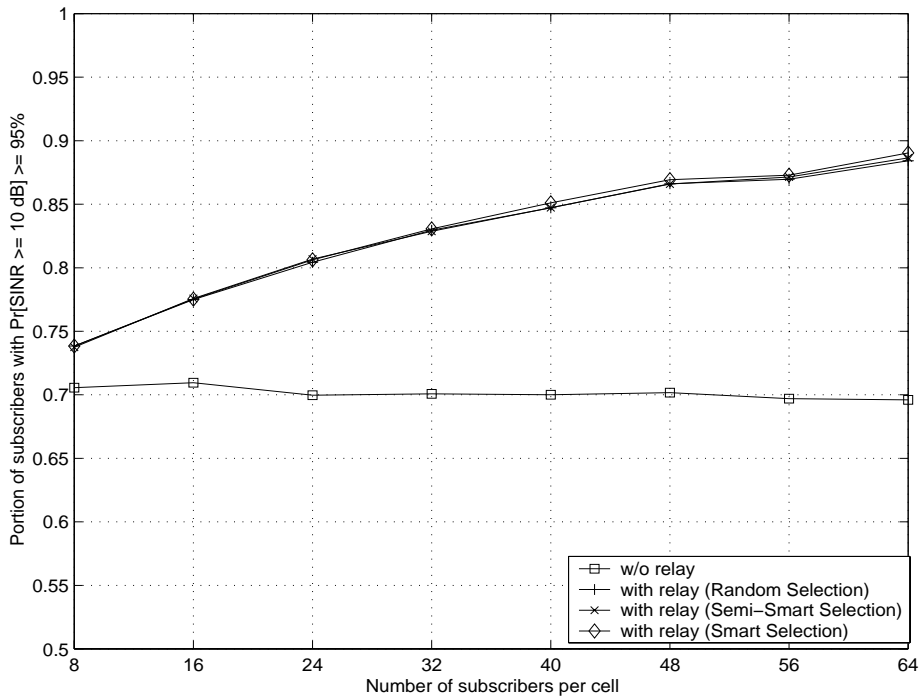

**Figure 29. User Coverage vs. Number of users per cell (for 400x400 m cell size, Maximum Relay Node TxPower: 1 W, Power Control, Semi-Smart Channel Selection).**

## 5.6 Worst Case Performance vs. Best Case Performance

The results shown below, Figs. 30 and 31, where the relay node set restriction has been lifted, illustrate the different impact each combination of relay node and channel selection scheme has on the performance. The worst case combination is the Random selection scheme for both relay node and channel selection without power control, shown in Fig. 30, where the performance with relaying is consistently inferior to that without relaying for all the various maximum relay node transmit power level. Meanwhile, the best case performance is debatable (depending on the relay node's maximum power limit) between the Semi-Smart and Smart combination of relay node and channel selection with power control, as shown in Fig. 23 and 31 respectively.

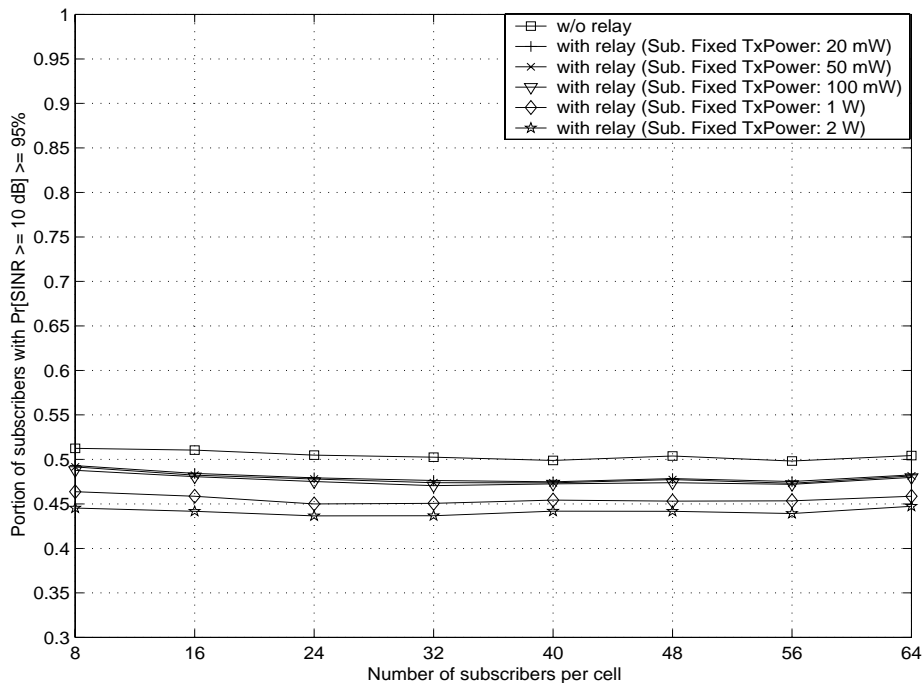

**Figure 30. User Coverage vs. Number of users per cell (for 400x400 m cell size, No Power Control, Random Relay Node Selection, Random Channel Selection).**

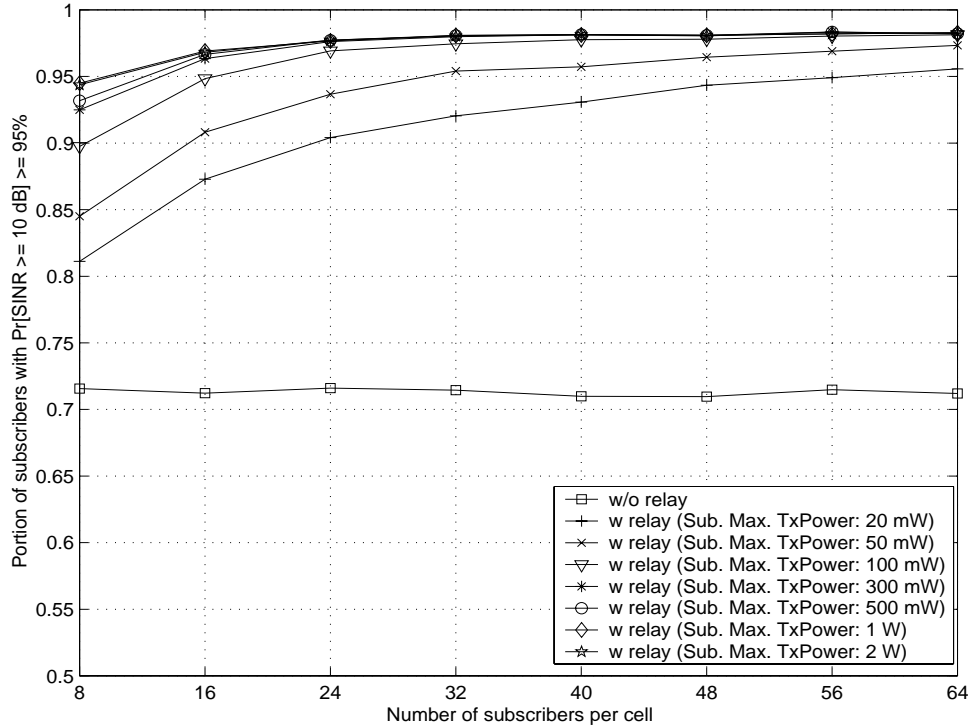

**Figure 31. User Coverage vs. Number of users per cell (for 400x400 m cell size, Power Control, Smart Relay Node Selection, Smart Channel Selection).**

Thus far, we still have not seen a significant difference in terms of the impact the Smart and Semi-Smart relay node selection has on the performance improvement. However, since the Smart selection involves probing the link conditions on all the hops along any given path, which requires more overheads, there must be some gain in this scheme over the Semi-Smart scheme. Therefore, for the next set of figures, we attempt to show the performance difference between the two by introducing an adaptive modulation technique in which the transmit power and the modulation level are adjusted in accordance to the SINR received, so that a constant BER is maintained for any given packet. In addition to the user coverage, we also attempt to quantify the average node throughput as another performance measure.

## 5.7 Impact of Adaptive Modulation and Power on Coverage

Adaptive modulation, a technique used to adapt the transmit power, modulation level, and/or code rate to the changing channel, is only beneficial if the channel conditions are good most of the time. When this occurs, adaptive modulation technique can offer a high link spectral efficiency without sacrificing the BER or considerable transmit power [6,8,19,33]. However, it requires having accurate channel estimations of the instantaneous received SINR, which in a high-speed mobile system, is difficult to obtain [19,22]. However, at low-speed mobility such as that of a pedestrian, channel state estimations may be obtained quite accurately [22]. Many options can be exploited; for instance, in [12] the power and data rate are adjusted while attempting to minimize the BER for systems with uncoded signals. In [3], the data and code rate are adjusted in accordance with the received SNR, reported back to the transmitter through a feedback channel, while the transmission is at full power so that a certain FER (Frame Error Rate) is maintained. In [8], the power, data rate, and code rate are all adjusted so that a maximum spectral efficiency is achieved while at the same time the BER is maintained at a minimum specified level.

For our purpose, in this simulation model, starting with the maximum transmit power, if the received SINR is greater than the minimum threshold required (provided below) the power is adjusted so that this received SINR approaches the next closest SNR value – that is lower than this received SINR – required for a given modulation level. The SNR required for a given modulation level is provided in Table 1 below. For any given modulation level, a constant BER is maintained. Furthermore, the following parameter assumptions are made:

- Each user has a BER requirement of  $10^{-5}$ , and a minimum SNR threshold ( $\gamma_t$ ) of 10 dB corresponding to BPSK.
- The signal is uncoded and the modulation schemes are BPSK, 4-QAM, 16-QAM, 64-QAM, and 256-QAM.
- The feedback channel is assumed to be error free with low delay so that the channel changes slower than the transmission symbol.
- Number of slots/frame: 8.
- Frame duration: 5 ms.
- Slot duration: 0.625 ms.
- Slot length: 512 symbols.
- Frame length: 4096 symbols.
- Continuous transmission (continuous packet arrival rate).
- Instantaneous Bit Rate per channel:

$$R_i = (\text{Slot length (in symbols)} * (\text{bits/symbol})) / \text{frame time.} \quad (29)$$

- Average Bit Rate per node:

$$S_i = \sum_{i=1}^N (R_i) / N, \quad (30)$$

where N is the total number of received SINR samples (each SINR sample is then mapped to the modulation level, given in Table 1, to obtain the number of bits per symbol).

- Average Node Throughput:

$$T_{\text{avg}} = \sum_{i=1}^K (S_i) / K, \text{ where K is the total number of subscribers.} \quad (31)$$

- Same coverage definition as in chapter 4.

The instantaneous bit rate for a given packet and for a given node at any given time will vary according to channel condition. It is defined as, according to (29), the slot size (in symbols) multiplied by the number of bits per symbol (modulation level) used for that particular packet, and divided by the frame time. The average bit rate for a given node, according to (30), is defined as the sum of the instantaneous bit rate of each packet divided by the total number of packets (SINR samples) received. Meanwhile, the average node throughput (in a cluster) is simply defined as, according to (31), the sum of the average bit rate per node divided by the number of nodes in the cluster.

The table below provides the SNR value required, which is read off of the BER vs. SNR curve provided in [6,23], for each modulation level in order to maintain a constant BER of  $10^{-5}$ .

	$M$				
BER	2	4	16	64	256
$10^{-5}$	10.0 dB	13.0 dB	20.0 dB	26.0 dB	32.0 dB

**Table 2. Required SNR for each modulation level assuming BPSK, and multi-level QAM modulation techniques.  $M$  is the modulation level.**

The figure below, Fig. 32, differs from Figs. 23 and 24 (section 5.3.2) in that it involves adaptive modulation. In the next section, we will show the impact of adaptive modulation on the average node throughput.

Based on the figure, we observe a similar pattern to the case with no adaptive modulation. At the lower maximum transmit power, 20 mW, the Semi-Smart selection clearly outperforms the Smart selection (approximately 92% coverage versus 87% at a subscriber density of 72);

while, at the higher maximum transmit power, 1 W, the Smart selection offers a slightly better performance than the Semi-Smart selection (83% versus 82% at a subscriber density of 72). Moreover, since we are attempting to increase the spectral efficiency per channel ( $R_i/\text{slot}$ ) by allowing higher modulation levels to be employed – which correspondingly demands higher power – at the higher maximum transmit power, the co-channel interference is increased. This explains the inferior performance improvement at 1 W compared to that at 20 mW. This effect may not occur if the Smart scheme is used for channel selection, since this scheme protects the already established links by preventing a channel from being reused if reusing it would result in excessive interference to the active, co-channel links.

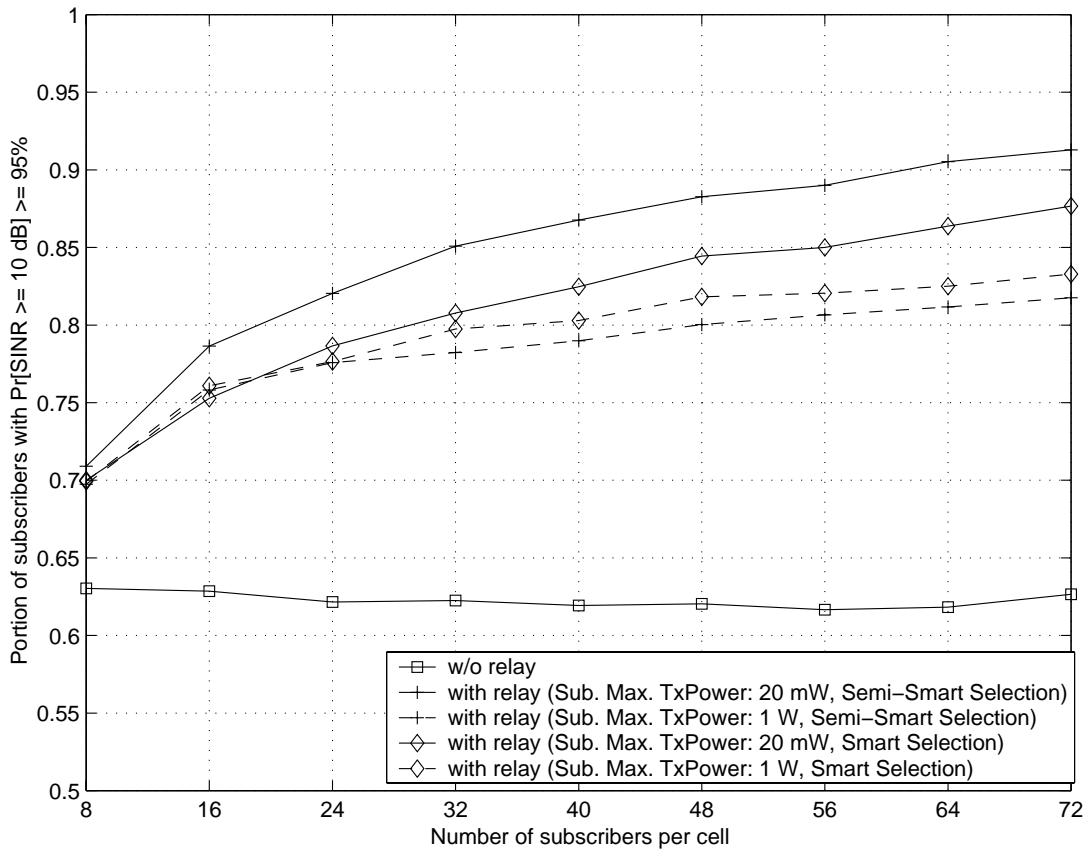

**Figure 32. User Coverage vs. Number of users per cell (for 400x400 m cell size, Power Control, Adaptive Modulation, Semi-Smart Channel Selection).**

## 5.8 Impact of Adaptive Modulation and Power on Average Node Throughput

It should be noted that the absolute values for the results shown below in Figs. 33-34 are not that important. What is important is the relative difference in performance due to relaying and as well to each relay node/path selection scheme. Fig. 33 is without adaptive modulation, while Fig. 34 is with adaptive modulation. According to Fig. 33, even without adaptive modulation we still obtain a slightly higher average node throughput due to relaying (approximately 108 kb/s compared to 97 kb/s at a subscriber density of 64).

With adaptive modulation, the advantage gained from relaying is even more pronounced as this can be witnessed (Fig. 34) by an even higher, compared to Fig. 33, average node throughput obtained with relaying compared to that without (an increase of approximately 70 kb/s here in average node throughput versus 11 kb/s in the no adaptive modulation case). Moreover, it is clear that the Smart selection outperforms the Semi-Smart selection at both maximum power levels (282 kb/s vs. 273 kb/s at a subscriber density of 72 and a maximum relay node transmit power of 20 mW). This demonstrates the benefits from having the additional link information (with the Smart scheme) of all the hops that constitute a relay path, at the expense of higher signaling overhead.

Furthermore, Figs. 35 and 36 present the percentage of times a certain constellation size is used. The two figures have in common the following: the relay node selection scheme is Smart selection, the channel selection scheme is the Semi-Smart selection, the maximum relay node transmit power is 20 mW. The only difference is that Fig. 35 corresponds to a subscriber

density of 8, while Fig. 36 corresponds to a subscriber density of 64. Although higher constellation sizes (i.e. 16-, 64-, and 256-QAM) are used more often with relaying compared to the case without relaying, their percentage use does not differ by much as the subscriber density per cell increases from 8 to 64. This reflects the trend observed in Fig. 34 for the Smart selection scheme. This observed trend could be due to a couple of reasons. One is perhaps due to the slow fading channel assumption whereby the capacity gain from adaptive modulation in this type of channel is not as great as that of a fast fading channel [34]. Another is perhaps due to the continuous traffic assumption whereby each subscriber is continuously receiving on only a single dedicated channel (i.e. there is no possibility of channels/timeslots aggregation for any subscriber).

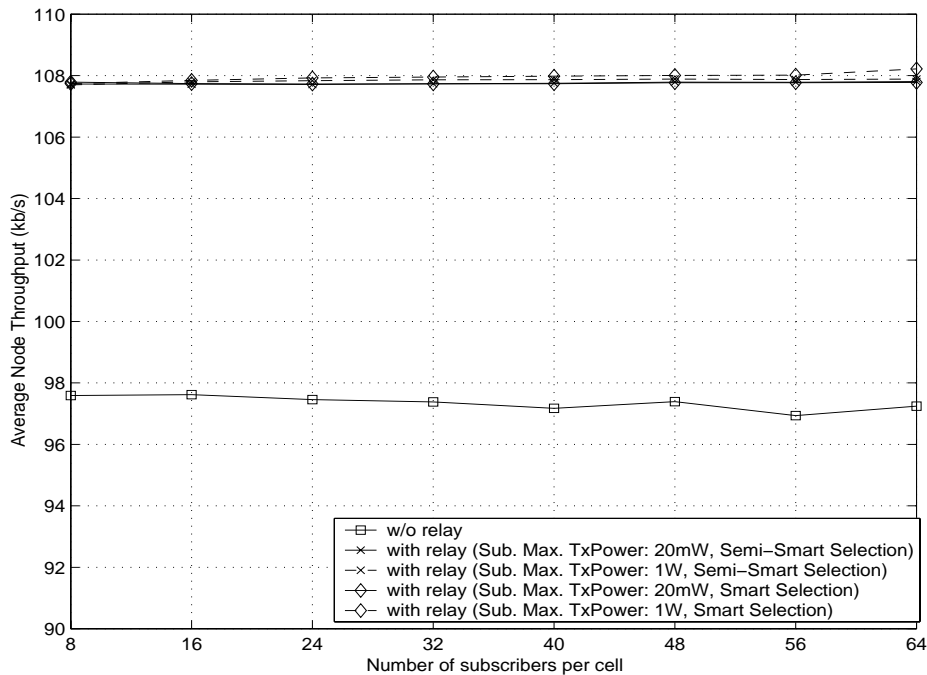

**Figure 33. Average Node Throughput vs. Number of users per cell (for 400x400 m cell size, Power Control, No Adaptive Modulation, Semi-Smart Channel Selection).**

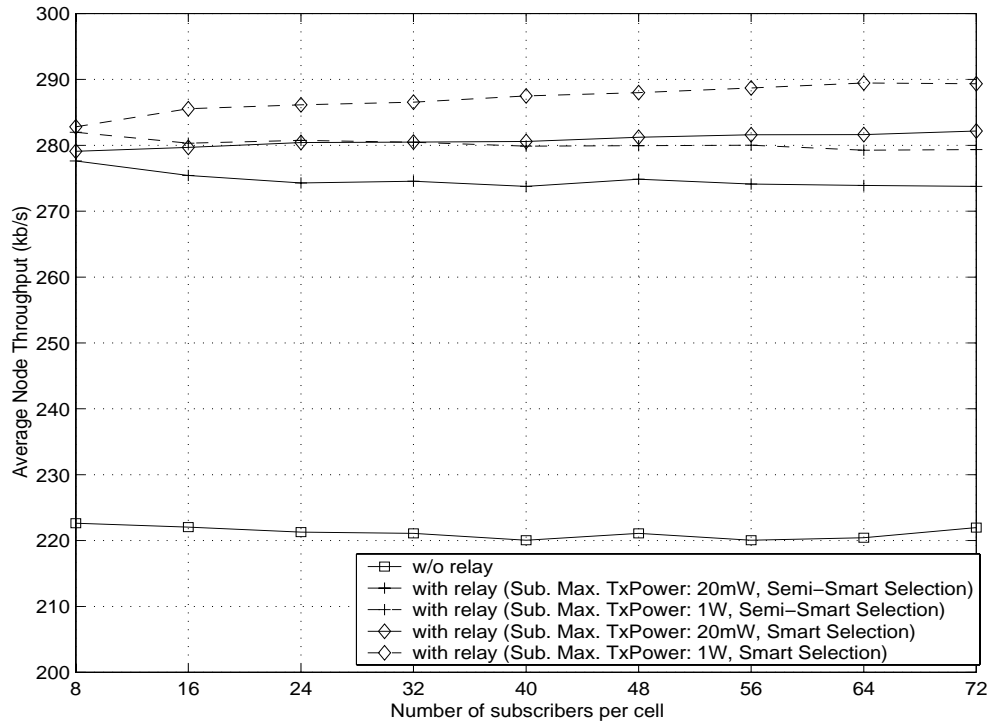

Figure 34. Average Node Throughput vs. Number of users per cell (for 400x400 m cell size, Power Control, Adaptive Modulation, Semi-Smart Channel Selection).

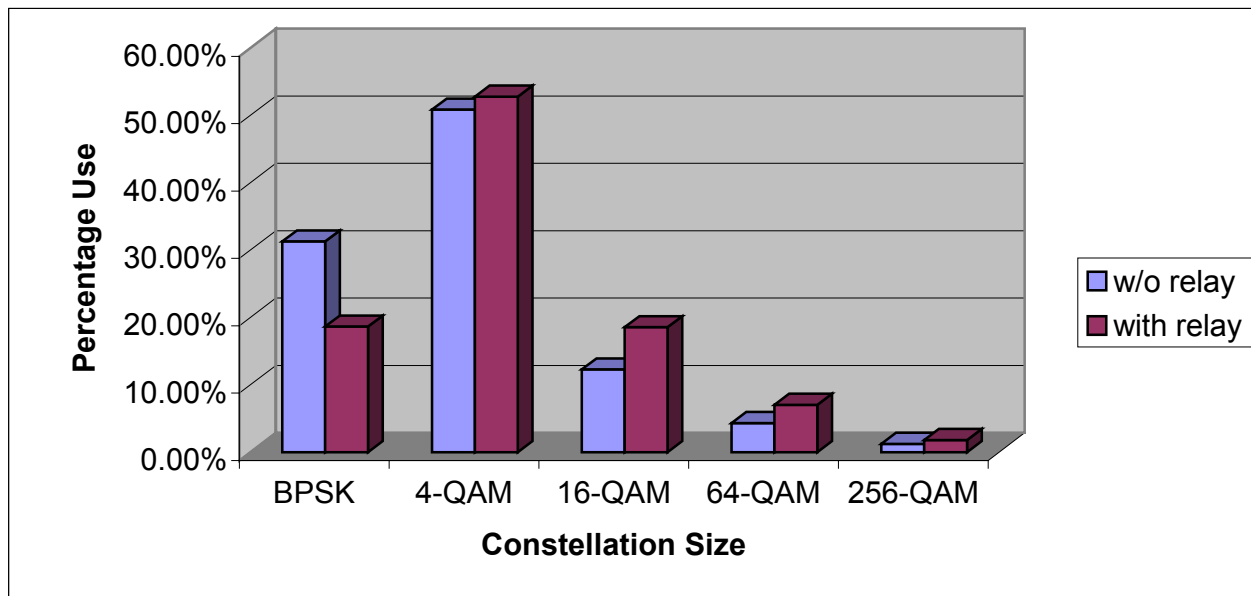
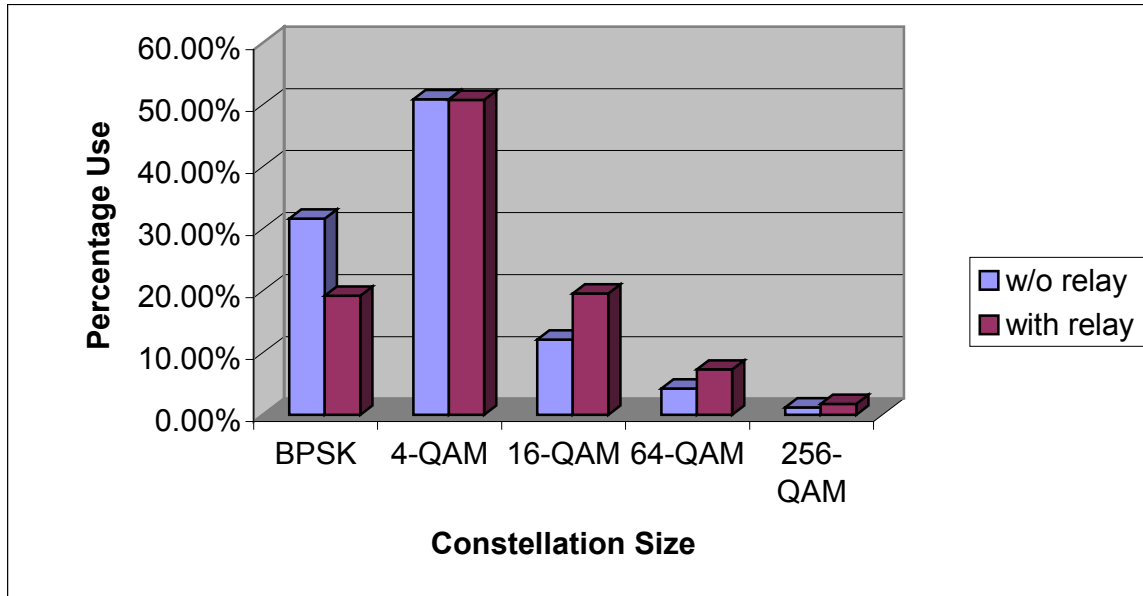

Figure 35. Percentage Use vs. Constellation Size (for 400x400 m cell size, Maximum Relay Node TxPower: 20 mW, Subscriber Density: 8, Power Control, Adaptive Modulation, Smart Relay Node Selection, Semi-Smart Channel Selection).



**Figure 36. Percentage Use vs. Constellation Size (for 400x400 m cell size, Maximum Relay Node TxPower: 20 mW, Subscriber Density: 64, Power Control, Adaptive Modulation, Smart Relay Node Selection, Semi-Smart Channel Selection).**

## CHAPTER 6

### DISCUSSIONS & CONCLUSIONS

#### 6.1 Results Summary

In this study we investigated whether there is a potential benefit from employing relaying in a fully loaded digital cellular system. Our results show that relaying can improve the system performance significantly, provided a good relay node/path selection is established. Therefore, based on our simulation results, the following conclusions are drawn:

- As can be witnessed in sections 5.2-5.8, relaying can reduce the maximum transmit power required to reach the receiver; however, whether relaying can lower the overall average power consumption in the long term has yet to be analyzed.
- The improvement due to relaying, with the use of power control, increases as the cell size is reduced, owing to the increase in cell density which consequently results in reduced average distances between mobile terminals (section 5.2).
- Even with as simple a selection metric as the geographic distance for relay node selection, a good performance improvement can still be gained from relaying (section 5.3.1, Fig. 22).
- In two-hop relaying, if there is a resource constraint (such as power and buffer space) at the relay node – which is usually the case since the mobile terminals are much smaller in size than the base station – then the Semi-Smart scheme of relay node selection is more attractive since this scheme requires less overhead and offers a better performance improvement than the Smart scheme (section 5.3.2, Fig. 23).

- Even though no extra bandwidth is reserved for relaying purposes and by adopting our adjacent-cell channel reuse proposal (section 5.4), a significant performance improvement can still be obtained through relaying.
- The difference in performance improvement between using Smart, Semi-Smart, and Random Channel selection is not very significant (section 5.4); therefore, if the overhead complexity involved in Smart or Semi-Smart selection does not justify the slight increase in performance return, it may be more advantageous to opt for the Random selection.
- Even with fewer candidate relay nodes, a substantial improvement can still be obtained from relaying (section 5.5).
- In addition to coverage improvement, the average node throughput can also be improved since techniques to increase the data rate, such as adaptive modulation, can be applied to take advantage of the good links obtained from relaying (section 5.8).

## 6.2 Further Discussions

According to our simulation results, relaying in a cellular system seems promising. However, it would be interesting to see how sensitive these results are to different environment and parameter assumptions. For example, by resorting to relaying we expect to obtain a good LOS and thus channel conditions, and therefore perhaps it is more appropriate to model the relay link by a Ricean channel instead of a Rayleigh channel. Furthermore, the lognormal shadowing standard deviation for a relay link should perhaps be lower than that of a base station-to-mobile node link. These and other parameters need to be refined and further simulations need to be carried out so that we have a basis for making a comparison.

Furthermore, throughout our simulations, we have assumed a digital form of relaying. With this assumption, there lies a possibility of detection error being introduced at each hop. Though the channel conditions are expected to be good the majority of the time due to relaying, at other times when they are bad, the Packet Error Rate (PER) at the final destination may be high if no error control technique is employed. Two forms of error control can be considered: Automatic Repeat Request (ARQ) and Forward Error Correction (FEC). ARQ is a high level error control technique involving store-and-forward and retransmission, which is subject to delay [32,35]. For voice traffic, which is delay sensitive, the digital form of relaying may not be suitable. In that case, amplified relaying, as presented in [4], should suffice since voice traffic does not require a high bandwidth and therefore the effect of noise accumulation at the destined receiver is not as great. A lower level of error control technique is the FEC, where the data packets undergo the process of channel coding and interleaving before being transmitted or forwarded [23,35]. Channel coding is a very effective mean for minimizing the Bit Error Rate (BER) at the destination. However, it requires a higher buffer space, bandwidth, and delay, which again may not be suitable for certain traffic types. Therefore, when relaying a certain traffic signal, factors such as number of hops, end-to-end delay, and BER must be considered.

One other issue concerns the mobility assumption, where in our model we have considered low-speed mobility such as that at the pedestrian speed. In a highly dynamic environment with high-speed mobility, it is doubtful that relaying – via mobile terminals – would be effective since it would be very difficult to obtain accurate channel measurements (due to a fast changing channel) and to perform inter-node tracking. For instance, while a relayed node is moving and its traffic is being relayed by another node, if it happens to be turning the corner of a building it can suddenly lose the relay connection. While this relay connection is lost, however,

it may find itself a viable link to the base station or to another potential relay node and thus require a new connection either with the base station or the new relay node. If this situation keeps occurring, a given relayed node may find itself requiring many handoffs, which could ultimately lead to service degradation. Hence, in a high-speed mobility environment, it may be difficult to retain a relay session for any useful period.

In the above situation, it is probably more effective to employ fixed relay stations such as those presented in [36], [38] and references therein. For example, reference [36] offers a solution to the problem of unbalanced traffic load among the differing cells through relaying whereby certain traffic from a congested cell are relayed via these so-called seeds or ad-hoc relay stations to a less congested neighboring cell. Further, [38] and references therein, under the heading of “ODMA”, proposes a capacity enhancement technique through relaying using fixed and mobile nodes as relay stations. The objective there is to increase the throughput particularly for those mobile terminals located near the edge of the cell, since they experience the weakest signal from the base station. Despite this drawback, one of the advantages with relaying using mobile terminals is that it can be easily extended to multi-hop relaying; meanwhile, using multi-hop relaying via fixed relay stations requires more stations to be installed, which may require a long deployment period, or incur more costs and overheads.

Another issue regards practicality. More specifically, a system wide relay-capable cellular network would be feasible if there is a full cooperation among all subscribers. Mobile terminals must remain on as long as there is traffic to be sent or received. Since long duration-relaying will drain the battery of the relay node, it may be inclined to shut off its device which would result in an interruption of service to the current relayed node. If too many forced handoffs occur unexpectedly, the relayed node would experience a dramatic QoS degradation.

One possible solution to this dilemma is through power distribution or power balancing, whereby relay nodes take turns in relaying for others. For instance, a time limit can be imposed on a relay session so that at a specified time the relayed node must be ready to handoff to a different relay node (assuming that there is another link available) or the base station once the time limit of the current relay link is about to expire. Although this scheme may still require significant handoffs depending on the imposed expiry time (which is also an issue), the benefit is that the overall power consumption in the system is eventually distributed among the relay nodes.

Lastly, this form of relaying generates other concerns as well such as security, and billing [36]. One major security hole found in the AMPS system is Theft-Of-Service [29], whereby a mobile terminal manages to steal the identity of another and uses the service without paying for it. It is very easy for a mobile terminal to steal the identity of another by eavesdropping on the information sent to the base station during the authentication period and sequentially programming its own handset to the newly discovered identity. This is possible because the AMPS system is an analog system and does not have the encryption capability [29]. The second-generation system such as the GSM however, which is a digital system, provides room for encryption of messages and thus authentication information is strongly encrypted [29]. Hence, digital form of relaying offers room for encryption of messages.

Billing management, in the context of relaying however, might be an issue. In addition to keeping records of the regular usage information for the purpose of charging, the service provider must also keep records of who was relaying to whom, and for how long so that some sort of compensation can be rewarded accordingly.

### 6.3 Future Research

In order to obtain further insights into the impact of relaying in a cellular network on the system performance, the following investigations should be considered:

- Using low height channel models for mobile terminal-to-mobile terminal link in order to validate our results since our model assumes same channel model as that of the base station to the mobile terminal, even though the height difference between a base station and a mobile terminal is quite significant.
- Capacity aspects of performance whereby only a limited number of channels are available for each cell, as opposed to our assumed linear increase of available channels to the number of subscribers per cell.
- Total power consumption and delay performance comparison for a cellular system without relaying, and with relaying incorporated.
- A coverage and throughput analysis on the impact of different relay node and channel selection schemes in a multihop relaying cellular network.
- A coverage and throughput analysis in a multihop relaying cellular network where subscribers have different QoS requirements such as that found in a multimedia network.
- Performance impact due to relaying when macrodiversity is incorporated in the system.
- Performance impact due relaying when other frequency reuse factors than 4 are used.
- Performance tradeoff between unicast and broadcast relaying. Unicast relaying is a point-to-point form of relaying as has been considered thus far. Meanwhile, broadcast relaying involves distributing the packet to all the forwarders that can hear the broadcast. Unicast and broadcast

relaying are the two relaying options found in HIPERLAN (High Performance Radio LAN) [35].

- Effectiveness of directional antennas for the subscriber terminals. Directional antennas have been studied in packet radio networks and have shown significant performance improvement over omnidirectional antennas, provided tracking can be managed [5]. However, in a high-speed mobility environment, tracking might pose too great of a problem to render their effectiveness.
- Performance tradeoff between single-route and multi-route relaying (as a form of diversity).
- Performance tradeoff between mobile and fixed relay station relaying technique.

## REFERENCES

- [1] G. N. Aggelou and R. Tafazolli, "On the Relaying Capability of Next Generation GSM Cellular Networks," *IEEE Personal Communications*, pp. 40-47, February 2001.
- [2] J. Banks, et. al, *Discrete-Event System Simulation*, Prentice Hall, New Jersey, 1999.
- [3] P. Bender, et. al, "CDMA/HDR: A Bandwidth-Efficient High-Speed Wireless Data Service for Nomadic Users," *IEEE Communications Magazine*, pp. 70-77, July 2000.
- [4] J. Boyer, "Multihop Wireless Communications Channels," Masters thesis, Carleton University, 2001.
- [5] C. Chang and J. Chang, "Optimal Design Parameters in a Multihop Packet Radio Network using Random Access Techniques," *IEEE GlobeCom*, Vol. 1, pp. 493-497, June 1984.
- [6] S. T. Chung, and A. J. Goldsmith, "Degrees of Freedom in Adaptive Modulation: A Unified View," *IEEE Transactions on Communications*, Vol. 49, pp. 1561-1571, Sept. 2001.
- [7] E. H. Drucker, "Development and Application of a Cellular Repeater," *IEEE Vehicular Technology Conf.*, pp. 321-325, June 1988.
- [8] A. J. Goldsmith, and P. Varaiya, "Increasing Spectral Efficiency through Power Control," *Proc. Int'l Conf. On Comm.*, Geneva, May 1993.
- [9] R. H.M. Hafez, *The GSM System*, Lecture Notes, Carleton University, 1996-2000.
- [10] R. H.M. Hafez, *Broadband CDMA Systems*, Lecture Notes, Carleton University, 1999.
- [11] T. J. Harold and A. R. Nix, "Intelligent Relaying for future Personal Communications Systems," *IEEE Colloquium on Capacity and Range Enhancement Techniques for Third Generation Mobile Communication and Beyond*, 2000.
- [12] J. Hayes, "Adaptive Feedback Communications," *IEEE Transactions on Communications*, vol. COM-16, pp. 29-34, Feb. 1968.
- [13] T. C. Hou and Victor O.K. Li, "Performance Analysis of Routing Strategies in Multihop Packet Radio Network," *IEEE GlobCom*, pp. 487- 492, June 1984.
- [14] R. Jain, A. Puri, and R. Sengupta, "Geographical Routing Using Partial Information for Wireless Ad Hoc Networks," *IEEE Communications Magazine*, pp. 48-57, Feb. 2001.
- [15] V.S. Kaunismaa, "On Frequency Radio (OFR) Repeater as Fade Filler," *IEEE Vehicular Technology Conf.*, Vol. 2, pp. 528-531, June 1989.
- [16] Y. Ko, and N. H. Vaidya, "Location-Aided Routing (LAR) in Mobile Ad Hoc Networks," *MobiCom*, pp. 66-74, 1998.

- [17] B. J. Leff, "Application Engineering Considerations for Cellular Repeaters," *IEEE Vehicular Technology Conf.*, Vol. 2, pp. 532-534, June 1989.
- [18] L. R. Maciel, H. L. Bertoni, and H. H. Xia "Unified Approach to Prediction of Propagation Over Buildings for all Ranges of Base Station Antenna Height," *IEEE Transactions on Vehicular Technology*, Vol. 42, No. 1, pp. 41-45, Feb. 1993.
- [19] R. A. Nobelen, J. Whitehead, and S. Timiri, "An Adaptive Radio Link Protocol with Enhanced Data Rates for GSM Evolution," *IEEE Personal Communications*, pp. 54-63, Feb. 1999.
- [20] S. Papavassiliou and L. Tassiulas, "Improving the Capacity in Wireless Networks Through Integrated Channel Base Station and Power Assignment," *IEEE Transactions on Vehicular Technology*, vol. 47, no. 2, pp. 417-427, May 1998.
- [21] C. E. Perkins, E. M. Royer, S. R. Das, and M. K Marina, "Performance Comparison of Two On-Demand Routing Protocols for Ad Hoc Mobile Networks," *IEEE Personal Communications*, pp. 16-28, February, 2001.
- [22] G. J. Pottie, "System Design Choices in Personal Communications," *IEEE Personal Communications*, pp. 50-67, October 1995.
- [23] J. G. Proakis, *Digital Communications*, McGraw-Hill, New York, Fourth Edition, 2001.
- [24] T. S. Rappaport, *Wireless Communications: Principles and Practice*, Prentice Hall PTR, 1996.
- [25] T. S. Rappaport, et. al, "Position Location Using Wireless Communications on Highways of the Future," *IEEE Communications Magazine*, pp. 30-37, Oct. 1996.
- [26] J. H. Reed, et. al, "An Overview of the Challenges and Progress in Meeting the E-911 Requirement for Location Service," *IEEE Communications Magazine*, pp. 30-37, Apr. 1998.
- [27] E. M. Royer, "A Review of Current Routing Protocols for Ad Hoc Mobile Wireless Networks," *IEEE Personal Communications*, pp. 46-55, April 1999.
- [28] S. Salamah, "Transmit Power Control in Fixed Cellular Broadband Wireless Systems," Masters thesis, Carleton University, 2000.
- [29] J. D. Solomon, *Mobile IP: The Internet Unplugged*, Prentice Hall PTR, New Jersey, 1998.
- [30] E. S. Sousa and J. A. Silvester, "A Spreading Code Protocol for a Distributed Spread Spectrum Packet Radio Network," *IEEE GlobCom*, pp. 481- 486, June 1984.
- [31] M. E. Steenstrup, *Routing in Communications Networks*, Prentice Hall, 1995.
- [32] A. S. Tanenbaum, *Computer Networks*, Prentice Hall PTR, New Jersey, Third Edition, 1996.
- [33] W. T. Webb, "Spectrum Efficiency of Multilevel Modulation Schemes in Mobile Radio Communications," *IEEE Transactions on Communications*, Vol. 43, No. 8, pp. 2344-2349, Aug. 1995.

- [34] W. Webb, "Broadband Fixed Wireless Access as a Key Component of the Future Integrated Communications Environment," *IEEE Communications Magazine*, pp. 115-121, Sept. 2001.
- [35] E. K. Wesel, *Wireless Multimedia Communications: Networking Video, Voice, and Data*, Addison-Wesley, Massachusetts, 1998.
- [36] H. Wu, C. Qiao, and O. Tonguz, "Performance Analysis of iCAR (Integrated Cellular and Ad-hoc Relay System)," *IEEE International Conf. on Communications*, Vol. 2, pp. 450-455, 2001.
- [37] O. Yue, "Design Trade-offs in Cellular/PCS Systems," *IEEE Communications Magazine*, pp. 146-152, Sept. 1996.
- [38] [http://www.3gpp.org/ftp/tsg\\_ran/wg1\\_r1/tsgr1\\_11/docs/\\*](http://www.3gpp.org/ftp/tsg_ran/wg1_r1/tsgr1_11/docs/*).