

SNE SIMULATION NOTES EUROPE

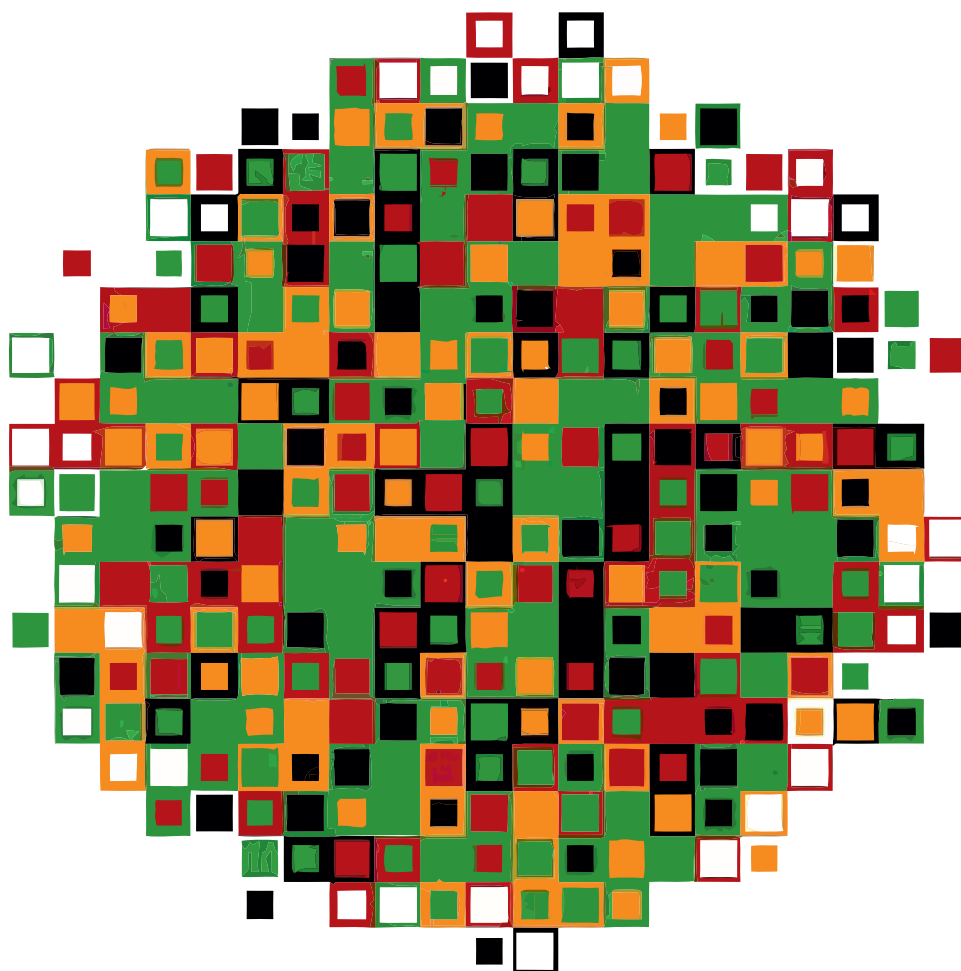

Volume 21 Number 3-4
December 2011

Print ISSN 2305-9974
Online ISSN 2306-0271



Journal on Developments and
Trends in Modelling and Simulation
Membership Journal for Simulation
Societies and Groups in EUROSIM





EUROSIM 2013

8th EUROSIM Congress on Modelling and Simulation

The City Hall, Cardiff, Wales, United Kingdom 10-13 September 2013



EUROSIM Congresses are the most important modelling and simulation events in Europe. For EUROSIM2013, we are soliciting original submissions describing novel research and developments in the following (and related) areas of interest: Continuous, discrete (event) and hybrid modelling, simulation, identification and optimization approaches. Two basic contribution motivations are expected: M&S Methods and Technologies and M&S Applications. Contributions from both technical and non-technical areas are welcome.

Congress Topics

The EUROSIM 2013 Congress will include invited talks, parallel, special and the poster sessions. The Congress topics of interest include, but are not limited to:

Intelligent Systems and Applications
Hybrid and Soft Computing
Communication Systems and Networks
Case Studies, Emergent Technologies
Workflow Modelling and Simulation
Web-based Simulation
Security Modelling and Simulation
Computer Games and Simulation
Neural Networks, Fuzzy Systems &
Evolutionary Computation
Autonomous Mental Development
Bioinformatics and Bioengineering
Circuits, Sensors and Devices

e-Science and e-Systems
Image, Speech & Signal Processing
Human Factors and Social Issues
Industry, Business, Management
Virtual Reality, Visualization and
Computer Games
Internet Modelling, Semantic Web
and Ontologies
Computational Finance & Economics
Systems Intelligence and
Intelligence Systems
Adaptive Dynamic Programming and
Reinforcement Learning

Methodologies, Tools and
Operations Research
Discrete Event /RT Systems
Mobile/Ad hoc wireless
networks, mobicast, sensor
placement, target tracking
Control of Intelligent Systems
and Control Intelligence
Robotics, Cybernetics, Control
Engineering, & Manufacturing
Energy, Power, Transport,
Logistics, Harbour, Shipping
and Marine Simulation
Semantic & Data Mining

Congress Venue / Social Events

The Congress will be held in the historic and magnificent City Hall in the heart of Cardiff, the capital city of Wales. The Gala Dinner will be held in the main hall of the National Museum of Wales. Social activities include visits to Cardiff Castle and Caerphilly Castle.

Congress Team: K. Al-Begain, A. Orsoni, R. Zobel, R. Cant, D. Al-Dabass; kbegain@glam.ac.uk

Info: www.eurosim2013.info

Editorial

Dear Readers – *SNE 21(3-4)* is the third *SNE* issue with new strategy and new layout: from *Simulation News Europe* to *Simulation Notes Europe*, from classical printed *SNE* with online copies to *Online SNE* with open access for basic contributions, and DOI® link registration for citation; we hope, these changes allow *SNE*'s development as modern publication.

This *SNE* issue also starts the new benchmark C20 'Complex Production System' – we thank the authors Sebastian Schreiber and Alexander Fay from Helmut-Schmidt-University Hamburg for setting up this benchmark, which extends the ongoing ARGESIM ModSim Benchmark (AMSB) C2 'Flexible Assembly System' essentially. Benchmark C20, of type Extended ARGESIM ModSim Benchmark (EAMSB) invites for solutions with documentations up to six pages, in range of full scientific publications. It is intended to define in future as well classical AMSBs and extensive EASMBs (on schedule is C21 'Hybrid Systems – Structural Dynamic Systems'). This new discrete benchmark together with the contribution on AssistSim (a support system for discrete modeling and simulation by Sigrid Wenzel et al from University Kassel), further five contributions on discrete simulation and two solutions to classical discrete benchmark AMSB C2 'Flexible Assembly System', establish discrete modeling and simulation as one focal point of this *SNE* issue. As counterpart, the other contributions show the very broad variety of modeling and simulation – from automotive and network applications to kinetics.

I would like to thank all authors for their contributions and all people who are helping to manage the changes in *SNE* and supporting the new publication strategy of *SNE*. Thanks again to Vlatko Ceric, who provided graphics for the cover pages of *SNE* Volume 21 – this issue with the third print from the series 'Compositions'.

Felix Breitenecker, Editor-in-Chief, etc@sne-journal.org

Contents

AssistSim – Towards Automation of Simulation Studies in Logistics. A.D. Latner, H. Pitsch, I. J. Timm, S. Spieckermann, S. Wenzel	119
Modeling Different Structures and Verifying Models from a System View with Window Regulators as Examples. Z. Xin, S. Petkun	129
Development of a Simulation-Based Process Chain – Strategy for Different Levels of Detail for the Preprocessing Definitions. T. A. Krol, S. Westhäuser, M. F. Zäh, J. Schilp, G. Groth	135
Integration of GIS Data in Health Care Utilization. G. Romstorfer, S. Parragh, G. Schneckenreither, M. Landsiedl, P. Einzinger, M. Scheuringer	141
Agent-based Modeling and Simulation of a Pastoral-nomadic Land Use System. P. Kuckertz, O. Ullrich, A. Linstädter, E. Speckenmeyer	147
Cycle Time Analyses of Plants by Automated Modeling Techniques and DEVS. R. Schoech, S. Schmid, C. Hillbrand	153
Dynamic Distributed Simulation of DEVS Models on the OSGi Service. M. Petzold, O. Ullrich, E. Speckenmeyer	159
Kinetic Model for Dose Equivalent - an Efficient Way to Predict Systems Response of Irradiated Cells. S. Scheidegger, R. Fuchsli	165
Robustness against Interference in Wireless Sensor Networks. S. Zacharias, T. Neue	171
Application of the Fourier Analysis for the Validation and Optimisation of Discrete Event Models. H.-P. Barbey	177
ARGESIM Benchmark C20 'Complex Production System' – Definition and Call Software. S. Schreiber, A. Fay	180
A Process-oriented Approach to ARGESIM Benchmark C2 'Flexible Assembly System' using AnyLogic with Java. S. Emrich, B. Malinowsky, O. Höftberger	191
A MATLAB-based Solution to ARGESIM Benchmark C2 'Flexible Assembly System' using SimEvents. T. Pingel, S. Pawletta	193
EUROSIM Societies Info & News	N1-N8

Reader's Info

Simulation Notes Europe publishes peer reviewed *Technical Notes*, *Short Notes* and *Overview Notes* on developments and trends in modelling and simulation in various areas and in application and theory. Furthermore *SNE* documents the ARGESIM Benchmarks on *Modelling Approaches and Simulation Implementations* with publication of definitions, solutions and discussions (*Benchmark Notes*). Special *Educational Notes* present the use of modelling and simulation in and for education and for e-learning.

SNE is the official membership journal of EUROSIM, the Federation of European Simulation Societies. A News Section in *SNE* provides information for EUROSIM Simulation Societies and Simulation Groups.

SNE is published in a printed version (Print ISSN 2305-9974) and in an online version (Online ISSN 2306-0271). With *Online SNE* the publisher ARGESIM follows the Open Access strategy, allowing download of published contributions for free. Since 2011 *Online SNE* contributions are identified by a DOI (Digital Object Identifier) assigned to the publisher ARGESIM (DOI prefix 10.11128). Print *SNE*, colour high-resolution *Online SNE*, full *SNE* Archive, and source codes of the *Benchmark Notes* are available for subscription via membership in a EUROSIM society.

→ www.sne-journal.org

✉ office@sne-journal.org, etc@sne-journal.org

✉ SNE Editorial Office, c/o ARGESIM / DWH, Neustiftgasse 57-59, 1070 Vienna, Austria

SNE Editorial Board

SNE - Simulation Notes Europe is advised and supervised by an international scientific editorial board. This board is taking care on peer reviewing and handling of *Technical Notes*, *Education Notes*, *Short Notes*, *Software Notes*, *Overview Notes*, and of *Benchmark Notes* (definitions and solutions). At present, the board is increasing:

Felix Breitenecker, Felix.Breitenecker@tuwien.ac.at

Vienna Univ. of Technology, Mathematical Modelling and Simulation; Austria, Editor-in-chief

Maja Atanasijevic-Kunc, maja.atanasijevic@fe.uni-lj.si

Univ. of Ljubljana, Lab. Modelling & Control, Slovenia

Peter Breedveld, P.C.Breedveld@el.utwente.nl

University of Twente, Div. Control Engineering, Netherlands

Agostino Bruzzone, agostino@itim.unige.it

Universita degli Studi di Genova, Italy

Francois Cellier, fcellier@inf.ethz.ch

ETH Zurich, Institute for Computational Science, Switzerland

Vlatko Čerić, vceric@efzg.hr

Univ. Zagreb, Fac. of Organization and Informatics, Croatia

Russell Cheng, rhc@maths.soton.ac.uk

University of Southampton, Fac. Mathematics/OR Group, UK

Horst Ecker, Horst.Ecker@tuwien.ac.at

Vienna Univ. of Technology, Inst. f. Mechanics, Austria

Edmond Hajrizi, ehajrizi@ubt-uni.net

University for Business and Technology, Pristina, Kosovo

András Jávör, javor@eik.bme.hu,

Budapest Univ. of Technology and Economics, Hungary

Esko Juuso, esko.juuso@oulu.fi

Univ. Oulu, Dept. Process/Environmental Eng., Finland

Kaj Juslin, kaj.juslin@vtt.fi

VTT Technical Research Centre of Finland, Finland

Francesco Longo, f.longo@unical.it

Univ. of Calabria, Mechanical Department, Italy

David Murray-Smith, d.murray-smith@elec.gla.ac.uk

University of Glasgow, Fac. Electrical Engineering, UK

Gasper Music, gasper.music@fe.uni-lj.si

Univ. of Ljubljana, Fac. Electrical Engineering, Slovenia

Thorsten Pawletta, pawel@mb.hs-wismar.de

Univ. Wismar, Dept. Computational Engineering,

Wismar, Germany

Niki Popper, niki.popper@drahtwarenhandlung.at

dwh Simulation Services, Vienna, Austria

Thomas Schriber, schriber@umich.edu

University of Michigan, Business School, USA

Yuri Senichenkov, sneyb@dcn.infos.ru

St. Petersburg Technical University, Russia

Sigrid Wenzel, S.Wenzel@uni-kassel.de

University Kassel, Inst. f. Production Technique, Germany

Author's Info

Authors are invited to submit contributions which have not been published and have not being considered for publication elsewhere to the SNE Editorial Office. SNE distinguishes different types of contributions (*Notes*):

- *Overview Note* – State-of-the-Art report in a specific area, up to 14 pages, only upon invitation
- *Technical Note* – scientific publication on specific topic in modelling and simulation, 6 – 8 (10) pages
- *Education Note* – modelling and simulation in / for education and e-learning; max. 6 pages
- *Short Note* – recent development on specific topic, max. 4 pages
- *Software Note* – specific implementation with scientific analysis, max 4 pages
- *Benchmark Note* – Solution to an ARGESIM Benchmark; basic solution 2 pages, extended and commented solution 4 pages, comparative solutions on invitation

Interested authors may find further publication and layout information at SNE's website → www.sne-journal.org (templates for *Notes*, requirements for benchmark solutions, etc.).

SNE Contact & Info

→ www.sne-journal.org

✉ office@sne-journal.org, etc@sne-journal.org

✉ SNE Editorial Office, c/o ARGESIM / DWH, Neustiftgasse 57-59, 1070 Vienna, Austria

SNE SIMULATION NOTES EUROPE

ISSN SNE Print ISSN 2305-9974, SNE Online ISSN 2306-0271

WEB: → www.sne-journal.org, DOI prefix 10.11128/sne

Scope: Technical Notes, Short Notes and Overview Notes on developments and trends in modelling and simulation in various areas and in application and theory; benchmarks and benchmark documentations of ARGESIM Benchmarks on modelling approaches and simulation implementations; modelling and simulation in and for education, simulation-based e-learning; society information and membership information for EUROSIM members (Federation of European Simulation Societies and Groups).

Editor-in-Chief: Felix Breitenecker, Vienna Univ. of Technology, Inst.

f. Analysis and Scientific Computing, Div., Math. Modelling and

Simulation, Wiedner Hauptstrasse 8-10, 1040 Vienna, Austria; ✉

Felix.Breitenecker@tuwien.ac.at, ✉ etc@sne-journal.org

Layout / Administration: Anna Mathe, ARGESIM / ASIM

✉ anna.mathe@tuwien.ac.at, ✉ office@sne-journal.org

Print SNE: Grafisches Zentrum, TU Vienna,

Wiedner Hauptstrasse 8-10, 1040, Vienna, Austria

Online SNE: DWH Simulation Services, Neustiftgasse 57-59, 1070 Vienna

Publisher: ARGESIM ARBEITSGEMEINSCHAFT SIMULATION NEWS

- WORKING COMMITTEE SIMULATION NEWS, Neustiftgasse 57-59,

1070 Vienna, Austria; → www.argesim.org, ✉ info@argesim.org

on behalf of ASIM (→ www.asim-gi.org and EUROSIM

→ www.eurosim.info)

© ARGESIM / EUROSIM / ASIM 2011

AssistSim – Towards Automation of Simulation Studies in Logistics

Andreas D. Lattner¹, Holger Pitsch², Ingo J. Timm³, Sven Spieckermann⁴, Sigrid Wenzel^{5*}

¹ Goethe University Frankfurt, Germany; ² INCONTROL Simulation Solutions, Germany; ³ University of Trier, Germany; ⁴ SimPlan AG, Germany; ⁵ University of Kassel, Kurt-Wolters-Straße 3, 34125 Kassel Germany, *s.wenzel@uni-kassel.de

Abstract Due to the complexity of production and logistics systems, more and more expert know-how is necessary for building adequate simulation models and for designing the right experiments for the requested aims of investigation. To support simulation studies as efficient and high-quality projects, there are different development activities like specialised unit libraries, model generation algorithms, procedure models or decision support systems. Based on the results of the joint research project *AssistSim*, this article presents a new approach of designing and executing experiments as one innovative possibility for support while performing simulations studies.

Introduction

Simulation is a well-established method for analysing and improving processes in manufacturing and logistics systems (e.g. [1] and [2]). Application of simulation methods can support troubleshooting as well as the assessment of planning variants. For example, the automotive industry does not invest in any material flow or manufacturing systems without simulating the systems to justify their decisions. However, the complexity of the systems to be modelled on the one hand, and the degrees of freedom in varying the model parameters to analyse the model and its behaviour on the other hand pose challenges even for simulation experts. In addition reduction of product lifecycles as well as reduced time for modifying production processes necessitate fast simulation results in even shorter time periods.

There are a lot of marketable discrete event simulation software packages with well-defined libraries and features for modelling and simulating manufacturing and logistics processes [3]. The challenges for simulation experts are to prepare valid data, to build valid models, to design dedicated experiments for the given aims of investigation and – all in all – to perform efficient and high-quality simulation studies.

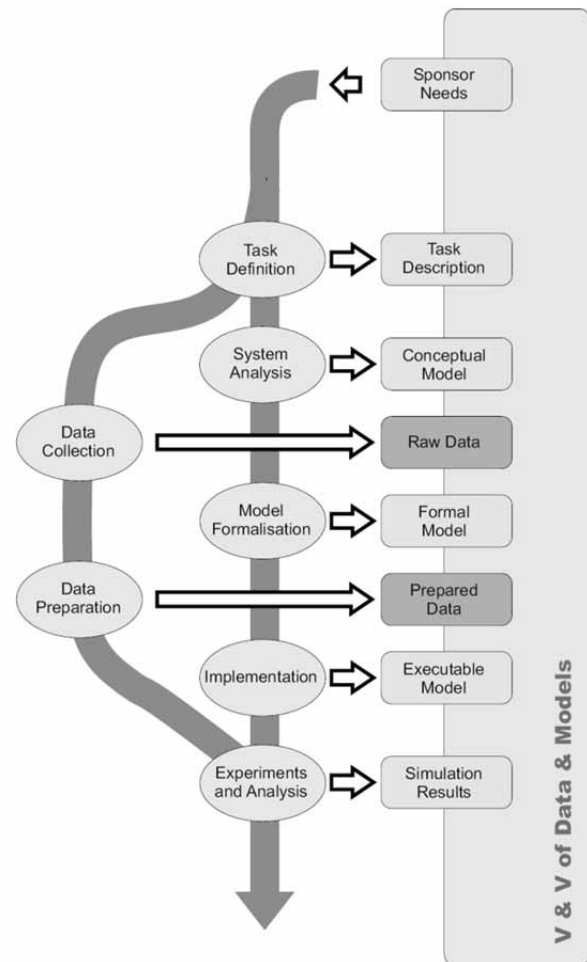

Figure 1. Procedure model for simulation including V&V [4].

One important quality aspect is about the design and the execution of the experiments. *Experiments and Analysis* as one phase of a simulation study (see Figure 1) is based on a valid executable simulation model and the prepared input data for this model.

The experiments depend on the complexity of the system and the aims of investigation, on the model parameters that need to be considered and on the interpretation of the simulation results by the simulation

experts with consequences for the system and the experimental design itself. Incorrect experiments produce unusable results for the given aims of investigation; experimentations with an insufficient number of simulation runs cause statistical inaccuracy or even lack of significance.

Therefore the joint research project *AssistSim* (HessenAgentur Project No. 185/09-15) was started in 2009, addressing the experimental design and execution in simulation studies as one of the challenges for simulation experts. The project goal is the development of a decision support software package for a standardised, systematic and semi-automatic design and execution of simulation experiments. The partners of the project consortium managed by SimPlan AG, a German simulation service provider, are the Goethe University Frankfurt, the University of Kassel, INCONTROL Simulation Solutions, Wiesbaden, UST Umweltsensortechnik GmbH, Geschwenda, and representatives of the industry workgroup 'Ablaufsimulation (Process Simulation)' within the VDA (German Association of the Automotive Industry).

In this paper we present the results of the joint research project. After a short discussion of some related work, the underlying logistics scenario and the defined assistance requirements are pointed out in Section 2. Subsequently the implemented assistance mechanism for simulation experiments divided into the experimental design assistance and the simulation execution assistance are described (Section 3 and 4). *Finally, a discussion of the results* (Section 5) as well as some information about future work (Section 6) *concludes this paper.*

1 Related Work

To enhance the accomplishment of simulation studies for production and logistics and to ensure high-quality simulation results, there are several research efforts which may be classified as follows:

- Procedure Models
- Automatic Model Generation Concepts
- Auxiliary Tools for Statistics, Optimisation or Visualisation
- Decision Support Systems

Procedure models define a systematic procedure for performing simulation studies (for example see Figure 1

or cf. [5] for an extended procedure model), for verifying and validating simulation models, data and results (cf. [4]) or for information acquisition [6] and input data management and validation [7].

Automatic model generation concepts allow an efficient implementation of cost-effective models by utilisation of CAD data and working plan data. Therefore standardised models will be produced. For example, the automotive industry implements different strategies for (semi-)automatic model generation using specialised automotive unit libraries [8], [9], [10].

Auxiliary tools for statistics, optimisation or visualisation are software packages that can be used in addition to the discrete event simulation tools. They include specialised, but standardised functions for optimisation of model parameterisation, automatic execution of series of experiments, or result visualisation. Some tools may be used as an add-on tool only to one simulation package; some tools are implemented as general software for different simulation packages (e.g. [11]).

Decision support systems are computer-based tools which (as discussed in [12], p. 34) are integrated in the day-to-day business operations and are tailored according to the user's tasks, include a dedicated knowledge management, offer alternatives in handling the given tasks and last but not least assist the user to decide efficiently and reliably. Taking the definition above into account there are only very few research projects focused on supporting simulation studies by specialised assistance features. There is, however, one development referring to a tool for scenario definition and navigation for collaborative simulation tasks [13]; another development focuses on the implementation of organisational functions for managing simulation studies [14].

2 Logistics Scenario and Requirement Analysis

In order to derive the assistance requirements during the execution of a simulation study, it turned out to be very helpful to use a specific example. Ideally, this example would not be too complicated and would at the same time illustrate the typical challenges of a real-world production or logistics system. The Institute of Prof. Wenzel at the University of Kassel provides a sample production system (cf. [15]) to the project, which has been developed for their engineering master program. This system, shown in Figure 2, comprises various production resources, conveyors, and an in-process high bay storage.

The set-up of the sample system allows a characteristic analysis such as:

- What is an appropriate configuration for the die casting machines downstream of the bay?
- Is it possible to run the upstream part of the shop in two shifts and the rest of the shop in three shifts?

In order to tackle suchlike rather general questions, they need to be broken down to some objects and object parameters. With regard to the first question one could, e.g., modify the number of die casting machines by adding or removing the fourth machine. Additionally, different dimensions of the storage might impact the utilization of the machines (by better de-coupling breakdowns in upstream areas). And thirdly, the speed of the storage and retrieval machine could improve or worsen the supply of the die casting area.

Today, a simulation analyst most likely would identify the investigation questions of the study, related objects and parameters during system analysis together with planning or application engineers of the real-world system. These questions themselves would be either raised directly by the application engineers, or the simulation analyst would unveil it in interviews bringing in his experiences from earlier simulation projects. Questions, related objects and parameters would be documented in a rather informal way in meeting minutes, presentations or (at best) in a requirements specification typically using the office tools at hand.

After completion of the model building process, the simulation analyst would (usually again together with the application engineer) manually compile a list of parameter variations for the runs of the simulation model. The number of replications per parameter configuration, the run-in period and the test of results on statistical significance would also be done manually and the results would be stored in different ways again (spreadsheets, presentations, sometimes in database tables). The conclusions finally presented by the simulation analyst to the application engineer and his management are again put down in presentations.

This description makes clear that today planning, running and assessing simulation experiments are handcraft with many manual steps (even though an executable simulation model itself is implemented and processed on a computer and even though a couple of auxiliary tools is available; cf. Section 1).

However, an assistance system for experimental design and execution does not only open up room for improving a single simulation study. It might also become a source for knowledge management. If the workflow described previously in this chapter, beginning with the verbalisation of analytic questions down to the assessment of simulation results is supported by a (semi-)automatic software tool, it will be possible to collect information during each step of the simulation project.

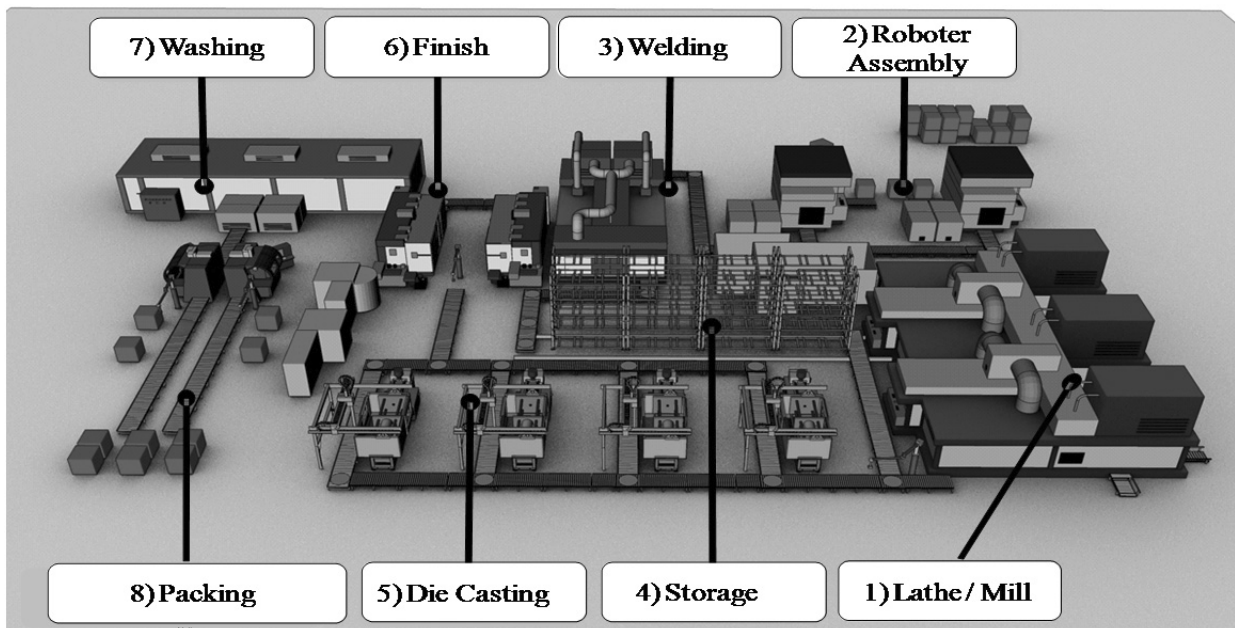

Figure 2. Sample model used for *AssistSim* evaluation (Copyright: University of Kassel, Department of Production Organization and Factory Planning – pfp).

Thus, considering not only one but several simulation studies enables the development and continuous extension of a knowledge base. This knowledge base allows a simulation analyst – whenever a new study is started – to browse questions including associated objects, parameters, run lists and results.

Thereby, the study can be started a lot faster and smoother benefitting from experiences gathered in previous simulation projects. In extension of the current state-of-the-art not only simulation models and model components become re-usable, but (to some degree) project experiences.

The knowledge base, of course, will have to be acquired and maintained by companies and institutions which are using simulation on a regular basis and not only once in a while. But as soon as they are available they might also be proven to be a very valuable assistance for simulation beginners who can improve their learning curve.

As lined out in this section, the features of an assistance system might be arranged following the process steps of a simulation study. This leads to a division in features which support the planning of the study, the formulation of investigation questions etc. and in features which assist preparation, execution and assessment of simulation runs. The latter does have some similarities with experiment managers implemented by some vendors of commercial simulation software packages (cf. Section 1). However, the mechanisms sketched out in Section 4 are not dependent on one specific simulation software. Additionally, some extensive functionality for distributing simulation runs is introduced.

The planning features capturing questions and targets of simulation studies and relating those to objects and data definitely is beyond the scope of existing experiment managers.

3 Experimental Design Assistance for Simulation Studies

The approach of the assistance system for simulation studies is to support and guide the user of a simulation tool throughout the whole simulation study. In detail, this means that the assistance already starts when the user might know nothing more than an initial description of the problems which be solved by using simulation. Here, it does not matter if the user is already a simulation expert or not.

While standard support features of current available simulation tools are limited to the guidance through their own experimental functionalities the aim of *AssistSim* is to support the user in setting up the right experiments for his specific problem, and to assist him in performing these experiments correctly.

Hence, the assistance mechanism for simulation experiments has to be divided into two parts:

- Experimental design assistance
- Simulation execution assistance

While the assistance regarding execution and control of simulation experiments is described in the following section 4, the fundamental experimental design assistance concept, so to speak the assistance steps from the idea to the experiment are described in this chapter. The basic structure of the assistance system in both, the experimental design as well as the execution assistance, is shown in Figure 3.

The first step of a simulation study is to define the goals of the study. The goal might be given as an investigation question to be answered, e.g. ‘Is the current storage still sufficient in case of a change in volume und content of the orders?’ This is a typical verbal formulation of a question which acts as a starting point of a simulation study. Unfortunately, this formulation does not lead to any experiments directly. Thus, the next step has to be the transformation of this informal verbal description of a problem into one or more objectives of investigation which can be analysed by a simulation.

The transformation has normally to be performed by the simulation expert. In case that he is a consultant he has to do this together with the customer. Due to different levels of expertise or experience, this transformation might mislead the whole project. Hence, a support for this basic, but very important step in the experiment preparation is required. The approach of *AssistSim* for this step is its integrated reference database in which comparable goals and questions of previous simulation projects are stored. The reference database delivers the concrete objectives of investigation for the given goals based on their integrated checklists (see also [16]).

In case of the example given above, potential objectives delivered by the checklist ‘Storage’ might be ‘Speed of the Automated Storage and Retrieval System’, ‘Storage Capacity’, and ‘Storage Policy’.

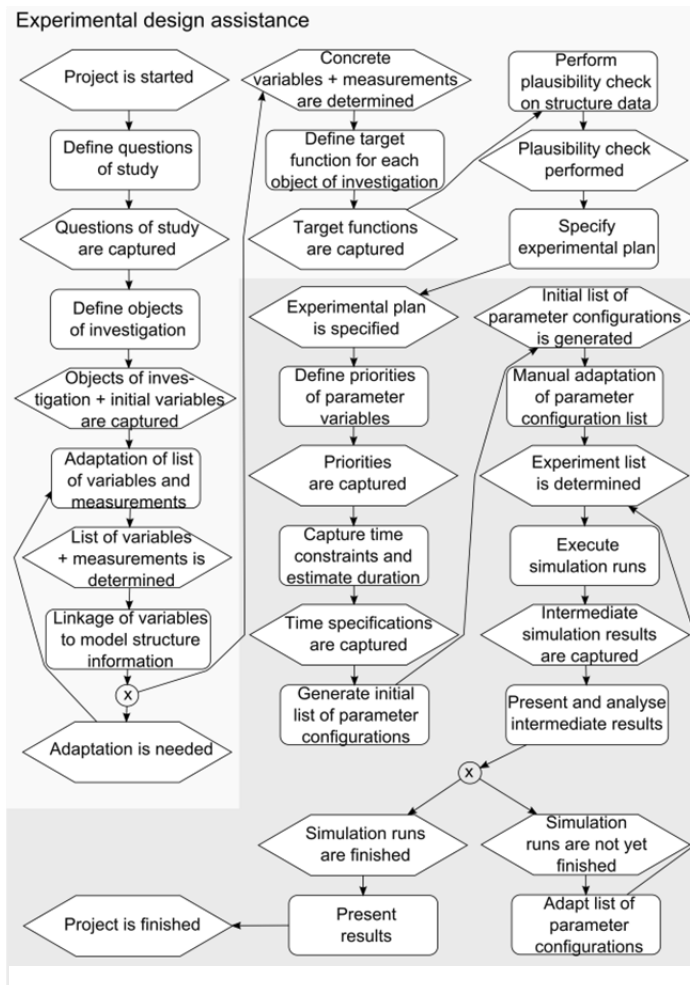

Figure 3. Experimental design assistance and simulation execution assistance

All elements taken from the reference database as well as any inserted or linked data are stored into a project related database by the assistance system. In case that a project goal is not yet available in the reference database the user is able to select a comparable problem. It is also possible to define a new scenario and save it to the reference database later on. By this, the size as well as the expertise of the reference database and therefore its scope of application grows with every new project. According to the objectives, the reference database delivers the corresponding necessary initial variables and measurements. Herewith, the danger of missing an important variable or measurement is reduced. But, if required, the user will be able to enhance or to modify the list of variables and measurements in case that the ones suggested by the reference database do not cover his needs completely, or even if he likes to get insight in additional objectives.

Once the list of variables and measurements is determined, these still model-independent variables need to be linked to the structural information of the underlying simulation model. Basically, this is achieved by setting up references from the tables within *AssistSim* to the simulation object specific parameters in the simulation models. These parameters might be collected in tables within the model, or just be given in object specific user interfaces.

During this process it might become obvious that the list of variables and measurements needs further adaption. Thus, the *AssistSim* application offers this capability of a manual adaptation as well.

Once the list of linked variables and measurements is finalised, the user is assisted in defining target functions for each selected objects of investigation. In case of the example given above potential target functions could be e. g. 'Maximise the storage capacity', and 'Maximise the throughput of the storage where the minimum throughput is never less than 1.500 entities per day'. When the target functions are captured and stored into the project related database, a plausibility check on the structural information of the current model has to be performed. This test is necessary to ensure that the available information and data can be used in order to achieve the goal of the simulation study. If, for example, the given range of values of a certain parameter indicates that a single component specified in the model will never achieve the performance level which is necessary to fulfil the given restrictions, the dataset, or even the target functions have to be adapted or improved.

Once the plausibility check is successful, the final step of the experimental design assistance, the specification of the experimental plan starts. In this process step the user is assisted in configuring the value ranges of all the parameters defined as variables. These ranges will be used in several simulation runs during the experiment in order to determine the most adequate set of parameters to achieve the requirements formulated in the target functions.

When the value ranges as well as the increments are set for all variables, the experimental plan is captured in the project database, and the design of the experiment is finished.

Afterwards the user can choose whether to start the experiment immediately by selecting the simulation execution assistance, or just to save the preparation of the experiment in the database for use at a later point of time.

The assistance in designing a simulation experiment as described above is not yet known in or for any available, commercial simulation tool. However, most of the possible mistakes are done especially in these early steps of a simulation study, and lead to wrong or at least not usable simulation results. Furthermore, some of the steps from an informal problem description up to an experimental plan are somewhat challenging when a user performs them manually, especially, if the user is less experienced. Knowing this, some people decline to use the method of simulation in order to solve problems.

Hence, the functionalities of the assistance system for designing simulation experiments are quite a big step ahead, and will ease the use of simulation. By this, simulation becomes more attractive to a broader audience. Once the experimental design of a simulation study has been completed, the information needed for the actual execution of the desired simulation runs is provided. The different process steps of the simulation execution assistance are shown in the second part of Figure 3.

4 Simulation Execution Assistance

The specification of the experimental plan can be seen as the interface between experimental design and simulation execution assistance. In the first step of the execution assistance, priorities for the single parameter variables can be defined. The priorities can be used to determine the execution sequence of the simulation runs. Additionally, it will be possible to set time constraints if desired, i.e., to determine how much time is provided for simulation runs, and to estimate the duration for all experiments. With the provided information, it is also possible to compute the expected maximal number of replications of the simulation runs under consideration of the time constraints. The initial list of parameter configurations is generated and can be adapted manually by the user, before the actual execution of the simulation runs is initiated. Intermediate results can be evaluated automatically by the system. Depending on this analysis, the list of parameter configurations as well as the number of replications can be adapted in order to meet pre-specified requirements. After all simulation runs are finished, the process ends.

In the following subsections we describe the key concept of parameter configurations, the execution and control of the simulation runs, as well as the statistical evaluation which is performed during or after the execution of simulation runs.

4.1 Parameter Configurations

For the approach presented here, we assume that an executable simulation model is given, i.e., synthesis or adaptation of a simulation model is excluded. The provided simulation models consist of a set of parameters which can be varied and a set of measurements which are captured during simulation runs. We distinguish between parameter definitions and parameter instances (or shortly, parameters).

The parameter definitions have been defined during the experimental design. Each parameter definition consists of a parameter identifier and a parameter range. Parameter ranges are either interval-based or consist of a finite set of possible values. In the first case a lower and upper bound restricts the possible values of a parameter and a step size is defined in order to determine the level of granularity to investigate such an interval-based parameter.

While the set of parameter definitions and their ranges define the total parameter space to be taken into account, a parameter configuration can be seen as one individual assignment of parameter values to all defined parameter definitions.

Consequently, one parameter configuration can be used to parameterise the simulation model in accordance with the specifications of the experimental design assistance.

4.2 Simulation System Control

The simulation system control has two major tasks: 1) to identify which parameter configurations have to be executed and 2) to actually perform simulation runs in interaction with the simulation system.

In the first case, the strategy of identifying the next parameter configuration depends on the type of simulation study which is currently performed. If it is an optimisation task, an optimisation algorithm will determine the parameter configurations considered in the next step. In the case of an explorative study, a systematic execution of parameter configurations is performed. For such explorative simulation studies three different modes are defined in our approach (illustrated in Figure 4):

1. Replication-based execution
2. Parameter configuration-based execution
3. Automated parameter configuration-based execution

The replication-based execution generates one replication for each parameter configuration before the next replication of a parameter configuration is simulated. This leads to a ‘fair’ distribution of computation time to all parameter configurations.

The parameter configuration-based execution performs a desired number of replications by iterating through the sorted list of parameter configurations, i.e., all replications are generated for one parameter configuration before the next parameter configuration is taken into account. Using this strategy, the focus lies on performing the simulation runs for those parameter configurations with a higher priority first.

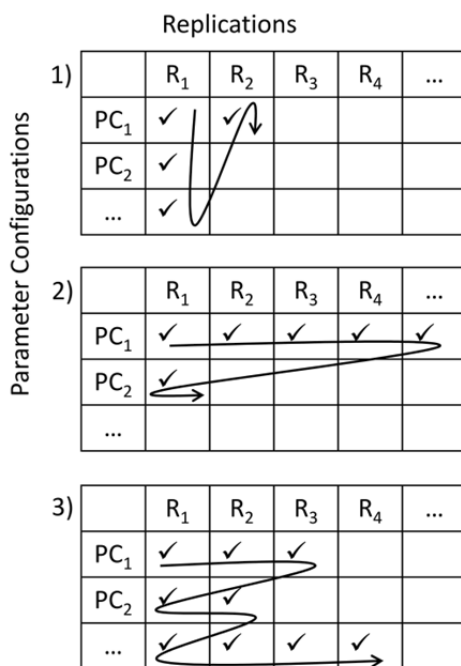

Figure 4. Strategies for performing the simulation runs based on given parameter configurations (PC) and replications (R).

The third strategy is similar to the parameter configuration-based strategy but does not necessarily generate the maximal number of replications for each parameter configuration. Before initiating the next simulation run of the current parameter configuration it is checked if the confidence interval widths of all measurements are

small enough in order to provide a (user-specified) sufficiently accurate value by taking into account the replications performed so far. This can lead to different numbers of replications for different parameter configurations.

For the execution of simulation runs, simulation jobs are sent to a simulation server which is able to distribute the jobs (i.e., simulation model, parameters, and seed values for the random number generator) to different simulation nodes.

4.3 Statistical Evaluation

A statistical evaluation can be performed in different contexts. Basic statistics are computed for every simulation measurement (e.g., manufacturing output) taking into account all measurement values of the different replications of a certain parameter configuration. The basic statistics consist of the following values:

- Minimal and maximal value
- Number of replications
- Mean, median
- Standard deviation, variance
- Sum
- 25% and 75% quartile values
- Interquartile range
- Confidence interval width (one-side)
- Skewness of the distribution
- Mode (lower and upper bound)

If a specific level of detail (desired maximal confidence interval width) is specified for a measurement, the automated parameter configuration-based execution (see Section 4.2) will compare the confidence interval width of the replications’ results to the desired maximal width in order to decide if more replication runs are to be performed for a parameter configuration.

Additionally to these basic statistics, the statistical evaluation allows for performing statistical significance tests in order to compare the results of different parameter configurations with respect to a particular measurement.

It is possible to specify a set of parameter configurations which should be compared and a pairwise t-Test is then performed and the corresponding probability-values are captured. These results can then be used in order to decide if a parameter configuration can be assumed to be superior to others.

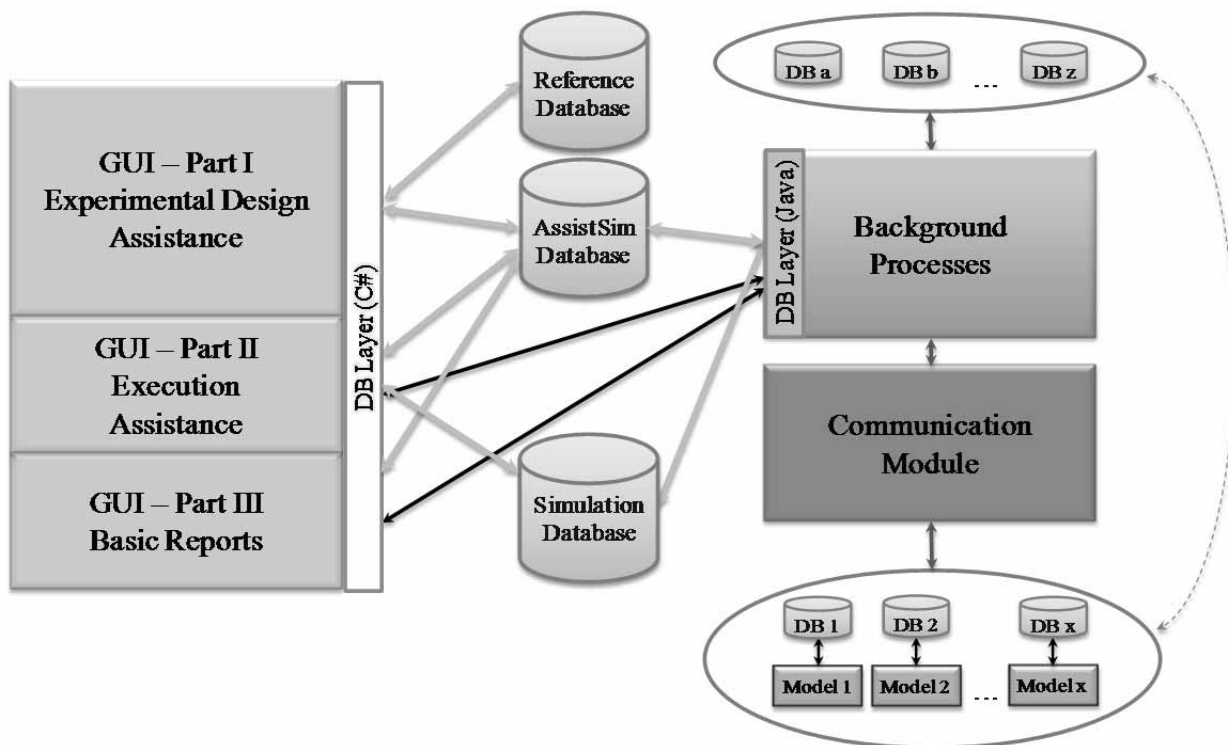

Figure 5. Components of *AssistSim* Software Prototype (DB – Database, GUI – Graphical User Interface).

Additionally to these basic statistics, the statistical evaluation allows for performing statistical significance tests in order to compare the results of different parameter configurations with respect to a particular measurement. It is possible to specify a set of parameter configurations which should be compared and a pairwise t-Test is then performed and the corresponding probability-values are captured. These results can then be used in order to decide if a parameter configuration can be assumed to be superior to others.

If more than two parameter configurations are compared, the thresholds for the significance values will have to be adapted in order to take into account the multiple testing issues and to avoid misleading interpretation of the significance tests' results.

5 Project Results

A large subset of the features described in the two preceding sections has been implemented in a software prototype during the joint research project *AssistSim*. The software architecture of this prototype does have several components as depicted in Figure 5.

There is a user interface to guide simulation experts through the process of designing experiments and executing simulation runs. Currently, the user interface also offers some basic reporting features (meant to be extended to some sort of reporting assistance). The related data (questions, objects and object parameters, data, parameter configurations, run lists, results etc.) are stored in the *AssistSim* database. A reference database serves as the knowledge base and provides information from earlier simulation studies.

Furthermore, there is a module for background processes such as run list generation and prioritisation, statistical evaluation etc. And finally, another component is responsible for the distribution of runs to several client computers in a computer network and for the control of these runs.

Note, that this communication module requires another piece of software to be installed on each client computer. In order for a client computer to be used for simulation runs, it needs (in addition to the communication software) to be equipped with a simulation software license of the respective simulation software package and it needs to have some spare processor capacity.

AssistSim is set up in such a way that it in principle can be connected to any simulation software package using a specific communication interface. This interface has been tested for Siemens PLM simulation tool Plant Simulation and for INCONTROL's simulation tool Enterprise Dynamics [17].

Until now, the *AssistSim* software prototype has been tested by some of the German car manufacturers (BMW, Daimler, VW) which are collaborating within the VDA (cf. [18]). Some intensive testing was also done using the sample production system shown in Figure 2.

The test results led to some minor changes and bug-fixing of the software. In general, the results proved the underlying concept of guidance and assistance throughout designing experiments and experimentation to be working goal-oriented and efficiently. Of course, since the software still is a prototype some refinements to the user interface and some other parts of the implementation are required. However, during the next month there are two tracks for improvement and enhancement: firstly, a related research project has been started just recently (cf. Section 6) and secondly and more importantly, the partners feel very confident about the benefit of the assistance functionalities that the development of the system will go on.

6 Conclusion and Future Work

The joint research project *AssistSim* has addressed different aspects for assistance while performing simulation studies. The focus of the project was set to two particular tasks of such a simulation study: the experimental design and the simulation execution.

The experimental design is supported by means to capture relevant information about principal questions of the simulation study up to the detailed identification of objects for investigation.

After finishing this task, parameter variables and measurements are identified and linked to the corresponding structure of the simulation model. The execution assistance performs a systematic investigation of the parameter space and initiates simulation runs in interaction with (potentially distributed) simulation systems and stores the corresponding simulation results of specified measurements in the *AssistSim* database. These results are then used in order to compute various statistical values and to perform statistical significance tests.

An extensive evaluation of the prototype developed within the project at different project partners from the automotive industry has indicated that the developed assistance functionalities are actually seen to be very helpful for the performance of simulation studies. The simulation expert is assisted in planning simulation studies in a systematic way. Additionally, the automated execution and control of simulation runs is a convenient way to perform many (parallel) simulations for the investigation of certain aspects of the simulated system and to capture results and statistical information about these runs.

The *AssistSim* project has mainly addressed the experimental design and simulation execution as tasks within simulation studies. For complex simulation models, an extensive amount of input data to build up the simulation model might be needed. Additionally, complex simulation studies can also lead to large amounts of output data which should be evaluated.

Due to the high relevance of an adequate capturing of input data and the evaluation of the simulation output data, we are investigating potential assistance functionalities for these tasks in the new joint research project EDASim – Development of a Data Assistance for Simulation Studies in Production and Logistics (Hessen Agentur Project No. 260/11-06).

Acknowledgements

The content of this paper is a partial result of the *AssistSim* project (HessenAgentur Project No. 185/09-15) which is funded by the European Union (European Regional Development Fund – ERDF) as well as the German State Hessen in context of the *Hessen ModellProjekte*.

We would like to thank all our project collaborators of the *AssistSim* development team for their effort in the conceptual design and development of the system, namely Björn Bockel, Tjorben Bogon, Markus Holzner, Ulrich Jessen, Pascal Katzenbach, Alex Müller, Markus Schmitz, René Schumann, and Stephan Stauber. We would also like to express our gratitude to our industry partners – the VDA industry workgroup 'Ablaufsimulation (Process Simulation)', in particular Gottfried Mayer (BMW Group), and UST Umweltsensortechnik GmbH, in particular Christian Loos, – for their valuable contributions in different phases of the project.

References

- [1] J. Bayer, T. Collisi, S. Wenzel (Hrsg.). *Simulation in der Automobilproduktion*. Berlin: Springer, 2003.
- [2] S. Wenzel, P. Boyaci, U. Jessen. *Simulation in Production and Logistics: Trends, Solutions and Applications*. In W. Dangelmaier, A. Blecken, R. Delius, S. Klöpfer (eds.): *Advanced Manufacturing and Sustainable Logistics. Proceedings of the 8th International Heinz Nixdorf Symposium, IHNS 2010, Paderborn, April 2010*, S. 73-84.
- [3] J.J. Swain. *Simulation Software Survey*. *OR/MS Today*, October 2009, <http://www.orms-today.org/orms-10-09/frsurvey.html> (online: 25. July 2011).
- [4] M. Rabe, S. Spieckermann, S. Wenzel. *Verification and Validation for Simulation in Production and Logistics*. In: SNE Special Issue 2009 'Quality Aspects in Modelling and Simulation', 8/2009, pp. 21-29.
- [5] H. Pitsch, O. Rose, S. Wenzel. *Quality Aspects in Simulation Studies for Production and Logistics*. In: SNE Special Issue 'Quality Aspects in Modelling and Simulation', 8/2009, pp. 5-11.
- [6] S. Kuhnt, S. Wenzel. *Information Acquisition for Modelling and Simulation of Logistics Networks*. In: *Journal of Simulation* (2010) 4 - published online 6. November 2009 doi10.1057/jos.2009.9, pp. 109-115.
- [7] A. Skoogh, B. Johansson. *A Methodology for input data management in discrete event simulation projects*. In: S. J. Mason; R. Hill; L. Mönch; O. Rose; T. Jefferson; J.W. Fowler (eds.) *Proceedings of the 2008 Winter Simulation Conference*. pp. 1727-1735. IEEE Omnipress, 2008.
- [8] S. Jensen. *Eine Methodik zur teilautomatisierten Generierung von Simulationsmodellen aus Produktionsdatensystemen am Beispiel einer Job Shop Fertigung*. Dissertation, Universität Kassel, 2007.
- [9] T. Rooks. *Rechnergestützte Simulationsmodellgenerierung zur dynamischen Absicherung der Montagelogistikplanung bei der Fahrzeugneutypplanung im Rahmen der Digitalen Fabrik*. Dissertation, TU Clausthal-Zellerfeld, 2009.
- [10] S. Strassburger, S. Bergmann, H. Müller-Sommer. *Modellgenerierung im Kontext der Digitalen Fabrik - Stand der Technik und Herausforderungen*. In G. Zülch, P. Stock (eds): *Integrationsaspekte der Simulation: Technik, Organisation und Personal*. Karlsruhe, KIT Scientific Publishing 2010, S. 37-44.
- [11] INCONTROL Simulation Software B.V. *Enterprise Dynamics Experimentation User Guide, 2009*.
- [12] B. Hellingrath, M. Kloth, M. Kluger, S. Wenzel. *Assistenzsystem unterstützt Planer und Betreiber*. *Materialfluss und Logistik*, Sonderpublikation, 1996, S. 32-38.
- [13] R. Bijlsma, V. De Gast, E. Valentin. *Deploying Decision Support Systems Based on Simulation Models*. In M. Rabe (ed.): *Advances in Simulation for Production and Logistics Applications*. Stuttgart: Fraunhofer IRB Verlag, 2008, pp. 531-544.
- [14] L. März, M. Saler. *Ein Analyse-, Planungs- und Entscheidungsinstrument für Lagerlogistikanwendungen*. In M. Rabe (ed.): *Advances in Simulation for Production and Logistics Applications*. Stuttgart: Fraunhofer IRB Verlag, 2008, pp. 237-245.
- [15] S. Wenzel, B. Bockel. *Ausbildung in der Digitalen Fabrik – Qualifizierung in Produktion und Logistik durch digitale Planungsmethoden*. In M. Schenk (Hrsg.): *Virtual Reality und Augmented Reality zum Planen, Testen und Betreiben technischer Systeme*. 4. Fachtagung zu Virtual Reality, 27.-28. Juni 2007, Magdeburg, S. 219-224 (CD-ROM).
- [16] B. Bockel, M. Schmitz, S. Wenzel. *Entwicklung von Methodiken zur systematischen Planung von Experimenten in Simulationsstudien*. In G. Zülch; P. Stock (Eds.): *Integrationsaspekte der Simulation: Technik, Organisation und Personal*. Karlsruhe, KIT Scientific Publishing 2010, S. 363-370.
- [17] INCONTROL Simulation Software B. V. *Enterprise Dynamics 8.2*. 2011.
- [18] G. Mayer, C. Pöge. *Auf dem Weg zum Standard – Von der Idee zur Umsetzung des VDA Automotive Bauteinkastens*. In G. Zülch, P. Stock (Eds.): *Integrationsaspekte der Simulation: Technik, Organisation und Personal*. Karlsruhe, KIT Scientific Publishing 2010, S. 29-36.

Submitted: September, 2011

Accepted: November 30, 2011

Modeling Different Structures and Verifying Models from a System View with Window Regulators as Examples

Zhao Xin, Sergey Petkun*

Brose Fahrzeugteile GmbH Hallstadt, Max-Brose-Straße 2, 96052 Hallstadt, Germany; *sergey.petkun@brose.com

Abstract. As the development of automobile industry, window regulator has evolved from manual window regulator to power window regulator with intelligent control. At present window regulator has turned into a complex mechatronic system. The electrical window regulator in a car is a classical example of mechatronic systems, because it contains all necessary components of mechatronic systems. With growing complexity from one hand and price pressure from the other, it is almost impossible to develop such system without good assistant tools. The system simulation helps to overcome the difficulties arising with requirements on market, such as shortening development time and decreasing its cost.

In this paper it is shown how two different types of window regulators can be modeled using a uniformed way. A cross arm window regulator and rail guided cable driven window regulator are based on different working principles. And the great difficulty is to model both types in the same simulator platform. The both systems share the same functionality, although they are fundamentally based on different mechanical solutions. The ranges of working conditions of both systems are so wide that it leads to natural desire to replace numerous tests with modeling. The generalized approach for modeling such systems is discussed and the verification of models is introduced, which is to compare simulation result with simultaneous paralleled measurement from physical window regulator systems. A very important question is discussed how detailed models should be built.

Introduction

Since the appearance of the first vehicle, window regulator has evolved through states of manual window regulator at the first beginning, electrical power window regulator and electrical power window regulator with intelligent control nowadays.

It turns from the simple mechanical component into complex mechatronic device, which involves not only mechanical structure any more but also electrical actua-

tor, electronic hardware, and software control for anti-pinch function [1]. With no doubt, window regulator has become mechatronic system. To develop such kind of mechatronic system, simulation turns out to be a good assistant method to face the challenge, because it saves time and cost for prototyping and increases efficiency and effectiveness to identify design failure in an early phase. Although simulation has lots of advantages over traditional techniques, it is not omnipotent. How well simulation could help in practical system development is still related to many factors. Basically, the system to be modeled comes to the first place and in this paper it is window regulator.

At present, cross arm window regulator and rail guided cable driven window regulator are the two structures of window regulator which are widely used in vehicle doors. As seen in Figure 1 and Figure 2, the structures of cross arm window regulator and double rail guided cable driven window regulator (double rail window regulator) are quite different. Besides, the two structures share no common in aspects of working principle, kinematic and dynamic properties.

The principle of cross arm window regulator is like a lever. It transforms and magnifies a rotational movement from electrical drive into a translational movement in glass moving direction. However, in double rail window regulator, electrical drive pulls cable, around cable drum, to lift up and pull down window glass through glass carriers. Such structure provides a constant glass speed, while cross arm window regulator does not. And cross arm window regulator has a poorer acoustic performance, compared with rail window regulator. Even cross arm window regulator is heavier than rail window regulator.

However, cross arm window regulator is not of no features. Its advantages over rail window regulator lie on the convenience of its install in vehicle door and the competitive price. So on and so on. There are even more aspects to compare and to show that the two widely-used structures of window regulators are different.

For many reasons, among which cost is the first one, simulation is used as an aided tool in the development of systems like window regulator. Another reason to utilize simulation is the increasing complexity of systems. And the third one is the great range of customer requirement hidden in the specification of functionality under all circumstances.

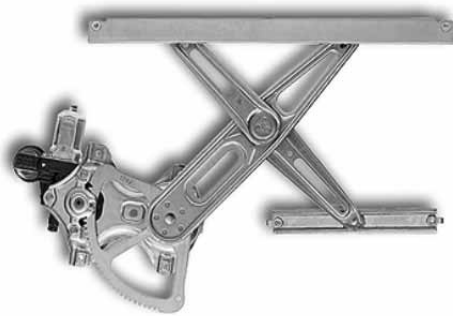

Figure 1. Cross arm window regulator.



Figure 2. Double rail guided cable driven window regulator

For these reasons, simulation is used in development of window regulators. Traditionally, it is easy to come up with the idea that the two window regulators could be modeled in a separated way. In the case of cross arm window regulator, the driving arm of cross arm window regulator is made of metal and it bends slightly in the direction of glass movement. If the bend of arms is neglected, the mechanism could be taken as rigid body and modeled as ideal levers [2]. In certain simulation environments like MSC Adams or SIMPACK, the model is easy to build on basis of multi-body dynamic system.

In a more complex way, when bend is taken into account, the strain and the stress of arms could be modeled as flexible body in FEM. For rail window regulator, there has not been a satisfactory way to model flexible cable, as its shape is changeful in space.

But it is possible to model the part of cable in rail window regulator with finite strain model [3]. Nevertheless, such method is too complicated to be implemented for the practical use. It is possible to implement artificial solution for flexible elements such as cable, but it is too expensive and the calculation duration increases dramatically. This approach requires also CAD data, which excludes the possibility of analysis at acquisition phase of projects when CAD data does not exist yet. From the other aspect, for system analyses, such method has no practical sense. In another method, cable is assumed as a spring with high stiffness [4].

Theoretically, it works to model the two types of window regulator separately by two methods. The disadvantage of such approach is that models of the two window regulator are irreplaceable. Practically it costs time and money to develop two set of simulation systems based on different simulation strategies. In reality, the requirements from the industry are [5]:

- Lower development time
- Lower cost
- Faster response of design and functionality failure at early phases of projects

Correspondingly, the goals of simulation [6] as an approach to develop mechatronic system in automobile industry, with window regulators here as examples, are:

- The simulation system should be capable to simulate the both constructions of window regulators
- The models of components should be substitutable
- Shorten the time to develop new models of window regulators for new projects

In this paper, a practice is presented, which avoids the disadvantage mentioned before, to model the two different structures of window regulator separated with two modeling methods. The practice witnesses the ability of simulation to meet the raised requirement of lower development cost and time in the fast developing automobile industry. In this case, modeling is brought from the level of individual parts up to the level of systems, which helps to understand what is necessary to model detailed in individual parts.

1 Modelling Different Structures from System View

The first question which has to be answered in this section is why the two structures of window regulators can be modeled within the same simulation system. The answer to such question is that modeling is carried out from a system view.

Window regulator is seen as a system, which means it consists of components with different functions and they interconnect with each other to build up complete system. In window regulator, the system consists of electrical drive, mechanical parts, electronic hardware and software. Electrical drive, electronic hardware and software, the standard parts, are used in both cross arm window regulator and rail window regulator. Each of the standard constituent components has the same functions and has the same ports to interconnect to each other. And the connection between these common parts and mechanical parts is uniformed to be identical for different window regulator systems. In this way, the two window regulators can be modeled

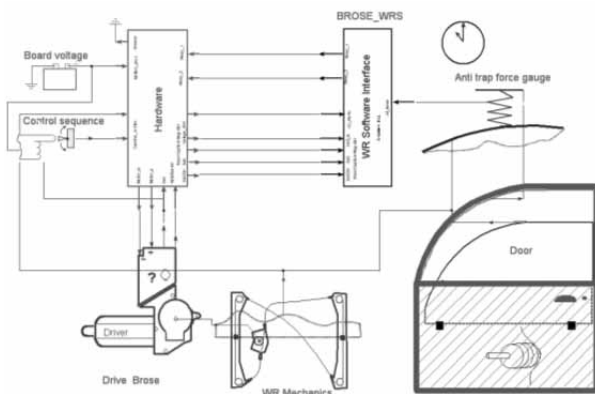

Figure 3. Diagram of rail window regulator in simulation [7].

As shown in Figure 3 and Figure 4, the uniformed connection points enable the two window regulators to be simulated in the same simulation system. The ports of mechanical parts are one port to connect to electrical drive and the other to glass position as output. It is the same for cross arm window regulator and rail window regulator.

From another point of view, the function of window regulator mechanism in door system is to lift up and pull down window glass. The electrical power is transferred into mechanical components by means of electrical drive. And it goes into window glass movement and also to overcome the friction between glass and door seal.

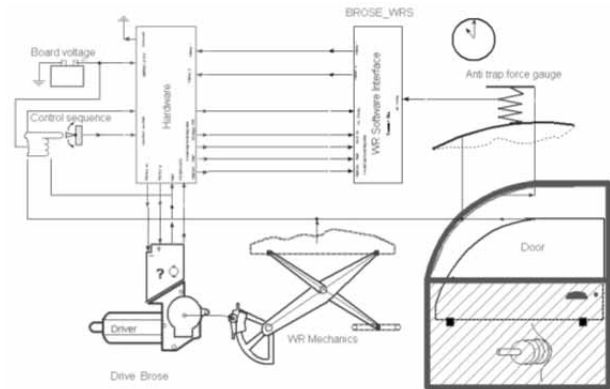

Figure 4. Diagram of cross arm window regulator in simulation [7].

It is the general function of window regulators and from this sense cross arm window regulator and rail window regulator have no difference. In a deeper level, window regulator could be taken as a black box to process the movement from electrical drive. The function of window regulator is just to transform the rotational movement from electrical drive into the translational movement of window glass. Additionally, every mechanical system has loss in form of friction, so it is with window regulators. It is just different how high the mechanical efficiencies of the two structures are. In summary, the main functionalities of cross arm window regulator and rail window regulator are the same, to lift up and pull down window glass. The same functionality makes it possible to model them in the same manner from a system view.

As mentioned above, window regulator system consists of electrical drive, mechanical part, electronic hardware and software. Electrical drive, electronic hardware and software are applicable to both cross arm and rail window regulator. Mechanical parts, which define window regulator system, classify window regulators based on different working principles. However, they have the common functionality, that is, to transfer force from electrical drive to window glass. Cross arm window regulator lifts window glass by leverlike arm, while rail window regulator does it by cable. How the two working principles are modeled is explained as in Figure 5 and Figure 6. In the case of rail window regulator, here with single rail window regulator as example, its model forms a closed loop, because all the components in rail mechanism are connected through by cable. Electrical drive drives cable drum, on which cable is held in great tension around. And cable goes through bowden, which is used to confine the path of cable.

The contact between surface of cable and bowden brings friction loss into system. Going out of bowden, cable goes around pulley. The contact between the two components brings friction too. Then cable is connected to glass carrier and from there cable goes around the other pulley, through the other bowden and then back to cable drum. Between one end of bowden and cable drum housing, compensation spring is implemented to prevent hard sudden contact. The tension in cable is also indicated by the deformation of compensation spring. As the analysis above, the components of bowden and pulley bring only friction into the system, which is indicated as $F()$, force change, in Figure 5. Compensation spring brings no loss of friction but only change of position, indicated by $P()$, as it has deformation. The rest of components, cable drum and glass carrier, brings not only friction but also change of position into the system. As cable is under great tension even when window regulator is at ease, the variation of cable deformation during window moving is so insignificant that the deformation of cable is neglected and cable is taken as a rigid body. In this way, all components of rail window regulator are interconnected to each other as in Figure 5.

From kinetic view, the rotational movement from electrical drive is transformed into translational movement at cable drum. The translational movement is changed after it goes through compensation spring, while through bowden and pulley the movement is unchanged, because the cable deformation through these parts is negligible. At glass carrier, the translational movement is transferred to window glass, which finishes the kinetic process. From dynamic view, the torque of drive is transformed into force, which overcomes the resultant force of friction from bowden and pulley, glass weight and friction from door sealing. However, in the case of cross arm window regulator, the model presents open loop. Rotational movement is transformed and processed by pinion segment, driving arm and supporting arm. The later two parts transfer movement to window glass. Dynamically, pinion segment, driving arm, supporting arm, supporting rail all brings friction into system. The torque from electrical drive has to bear friction from them and load from glass.

As seen in Figure 5 and 6, although the working principles of cross arm window regulator and rail window regulator are different, it is the same that the two types of window regulators transform movement from rotational one into translational one. So, the functionality of the two types of window regulators is the same.

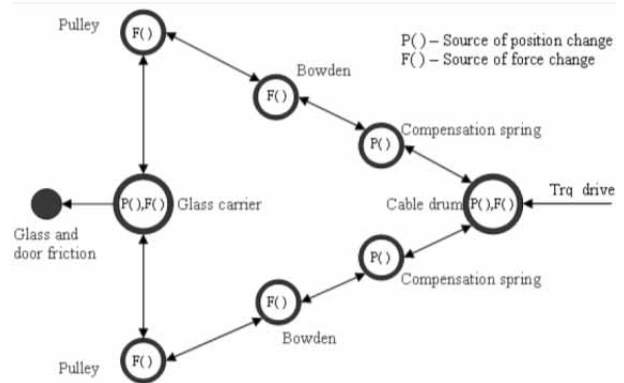

Figure 5. Diagram of single rail window regulator.

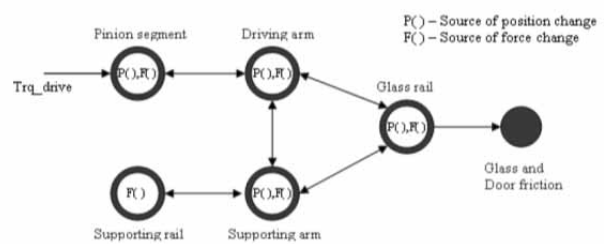

Figure 6. Diagram of cross arm window regulator.

Based on the analyses above, models of the two types of window regulators are built up in MAST modeling language, which is designed for Saber simulator from company Synopsys. MAST is not the only modeling language for implementation in this paper. Other modeling languages, like VHDL-AMS and Modelica, are also suitable. The next interesting question is how detailed parts should be modeled. It is about the depth of modeling. In another way to say, the question is whether it is necessary to model all the effects happening in parts. Simulation is powerful, but it is only in certain degree.

Simulation casts light only on one perspective of subjects but not all perspective, which is its limit. So, before simulation models are built, it is very necessary to set the questions which are supposed to be answered during simulation. It brings basic criteria to the question how detailed parts should be modeled. Here three suggestions are proposed for degree of subject modelling:

- The models should be at least able to answer the questions, which are supposed to be answered in simulations.
- All parts constituting system should be appropriate to each other. In another words, the models of parts should not be poorer than the least detailed parts in systems.

- The physical phenomenon or properties, which have relevantly very low impact on the simulation result compared with physical measurement, could be neglected from modeling.

2 Verification of Models

A model without verification is not practically useful, especially in the case of window regulator, which is highly related to reality. In this section, how to verify simulation models, paralleled to physical system, is presented. It exams how close the simulation models are to the real mechatronic system. The origin of the verification method is that window regulator is under controlling and monitoring of electronics all the time. The controlling signal to window regulator comes from electronics, which is in fact instruction or operation from human. And the feedback is rotational velocity information measured at electrical drive armature. Motor current is also possible as feedback. The rotational velocity information is sent back to electronics and electronics determines what to do and how to do in case of pinches.

For window regulator electronics, only velocity information is in focus and all other states about systems are calculated based on it. However, it does not matter whether the window regulator is real or not, only if it could provides electronics the correct velocity information. So, as shown in Figure 7, a control signal, which could be real control switch or virtual one, is given to window regulators. Window regulator model and real window regulator begin to move, no matter whether to move up or down. The speed information at electrical drive armature is measured in both physical system and simulation model and then sent to electronics, which could be implemented in real electronic hardware or virtually in computer environment. Electronics now could make calculation and then comparison between real window regulator and its model can be made paralleled.

In verification, simulation models are compared with real systems. In comparison, three components of window regulator are examined, that is, electrical drive, mechanism and door model. In fact, it is the synthetic performance of the three physical components that is compared with parts in real systems. However, before such verification is conducted with the integrated system, individual part should have been verified with corresponding part in reality.

Only with reliable verification, the synthetic comparison between the whole window regulator models and real window regulators is of meaning. In contrary, it is not necessary to verify the rest parts of system. The reason for it is that manual switch, electronic hardware and software can all be virtually released within computer as identically as in reality. The advantage of it is that various hardware and software implementations could be tested on the same mechanism to find out the best solution for commercial projects.

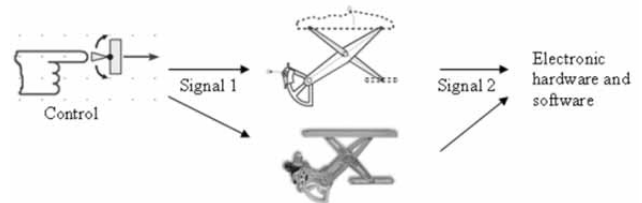

Figure 7. Method to verify models.

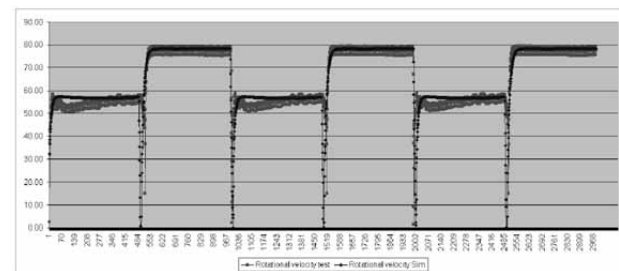

Figure 8. Comparison between simulation result and practical measurement.

In Figure 8, it is an example of verification, which compares the anti-pinch function of cross arm window regulator. The two signals in figure are the rotational velocity of electrical drive armature from both simulation and real window regulator. The movement of window regulators is under the control of manual switch. The manual control signal is to lift up window glass automatically from a lower position until it hits obstacle. Then anti-pinch function enables glass reversing. Again, control signal lifts up glass for another pinch event. During glass goes up, the electrical drive speed is lower because the load is the sum of glass weight and friction. While glass reverses, electrical drive speed is higher because gravity of window glass is working as an active factor.

In the figure, the darker signal is simulation result of motor speed, while the lighter one is the real measurement from real window regulator. It is seen that the two signals fit to each other approximately. Motor speeds during lifting up and reversing are at the same level, while they fit better during glass going down.

However, a difference happens at the start-up of lifting process. Motor speed of simulation has a smooth process to reach the stable value, while real system experiences a process of vibration before it reaches stable. From one aspect, the simulation models perform well to represent anti-pinch process of window regulator. With the same position of obstacle, anti-pinch function of simulation models is activated as the same time as real window regulator. Under such context, the models are acceptable.

However, from another aspect, it may not be acceptable because of the inaccurate imitation of motor speed at starting up. It comes back to the question how detailed models should be built or how close models should be to the real subjects. One thing is true that people can not expect simulation to answer once for all every question we are interested in. If simulation could answer the questions which are designed to be answered by simulations, the simulation is acceptable. If people would like to know more or further questions are raised during simulation, improved models have to be built and more effects of subjects should be taken into account. It is all based on expectation of simulation.

3 Conclusion

In this paper, a practice is presented, in which two different structures of electrical power window regulator with intelligent control were modeled. The method behind the practice could save the effort to build up two separated simulation system for window regulators based on two working principle. Meanwhile, it could also give possibilities to compare some different mechanical systems based on various principles and investigate their advantages and disadvantages. By utilizing uniformed interconnecting ports, standardized parts, like electrical drive, electronic hardware and software, can connect to mechanisms, which are based on different working principles, that is, cross arm mechanism and rail guided cable driven mechanism in this paper. The common functionality of the two structures of window regulators makes the uniformed interconnection possible.

Moreover, corresponding to modeling, verification of models is introduced. With the verification, simulation models can be compared to real window regulator system at the same time, which increases the effectiveness of models evaluation and improves the reliability afterwards. It saves also the effort to build up models for manual switch, electronic hardware and software. They can all be digitalized in computer with less cost. Then certain physical models, that is, electrical drive, window regulator mechanism and door, are examined precisely. At last, the criteria of the suitability of simulation models for designed purposes change all the time as the development of models.

The question, whether models are suitable or not, depends on factors, like the subjects to be modeled itself, the understanding about the being modeled subjects, the selection of modeling language and the powerfulness of computer hardware, so on. If the simulation models could satisfy the need of simulation assignments, it is acceptable. And if more information is required from simulation models, improvement and more physical effects have to be taken into account in building models. For this reason, several suggestions regarding the modeling level are proposed in the paper.

References

- [1] P. T. Schooler. *Anti-pinch power window system*. United States Patent 7021001.
- [2] H. B. Liao, D. B. Liu, X. H. Guo, Q. He, S. Y. Hou, Y. Y. Jin. *Superficial Analysis of Electric Window regulator*. Machine Design and Research, 2007.
- [3] N. C. Perkins, C. D. Mote. *Three-dimensional vibration of travelling elastic cables*. Journal of Sound and Vibration, Volume 114, Issue 2.
- [4] S. Petkun, S. Khader. *Dynamische Modellierung eines Antriebes mit Zugmittelgetrieben*. Robotik und Automatisierungstechnik, 47. Internationales Wissenschaftliches Kolloquium, TU Ilmenau, 23.-26. September 2002.
- [5] P. A. Murmann. *Expected development time reductions in the German mechanical engineering industry*.
- [6] D. C. Karnopp. *System Dynamics: Modeling & Simulation of Mechatronic System*. 4th Ed., 01-2006.
- [7] S. Petkun. *Modeling of mechatronic devices with Saber*. SNUG Europe 2008.

Accepted ASIM SST Winterthur, September 2011

Submitted: September 2011

Accepted November 30, 2011

Development of a Simulation-Based Process Chain – Strategy for Different Levels of Detail for the Preprocessing Definitions

Toni A. Krol^{1*}, Sebastian Westhäuser¹, M. F. Zäh¹, Johannes Schilp¹, G. Groth²

¹iwb Anwenderzentrum, Technische Universität München, Beim Glaspalast 5, 86153 Augsburg, Germany

²CADFEM GmbH, Grafing / Munich; * Toni.Krol@iwb.tum.de

Abstract. Additive manufacturing processes fulfill the actual market demands with regard to a high individuality and complexity of products. Hence, these processes are used nowadays in different branches (e. g. aerospace, automotive, medical industry). Further-more, a high process stability and reproducibility is requested by the user for an eco-nomic application of this technology. Up to now, these targets are reached by numerous test rigs on the manufacturing system which causes high resource consumption.

For increasing the efficiency of metal-based additive manufacturing (AM), the employees of the *iwb* application center Augsburg in corporation with the CADFEM GmbH and four further partners develops a simulation-based process chain (founded by the Bavarian Research Foundation). Before the production process is started, an analysis of the structural part behavior as well as a process optimization should be performed using the finite element analysis (FEA). Due to the complexity of the thermally activated process, it is necessary to select the appropriate FE-modeling strategy for enhancing the target figures calculation efficiency and accuracy. Hence, in this work a strategy will be presented, which can map different levels of detail for the preprocessing definitions. These local and global descriptions can be realized by using suitable contact definitions (contact elements) to link different element meshes. Additionally, the user can select different layers of the part geometry, which should be analyzed in detail within the simulation. Also layer-specific distortions and residual stresses can be calculated while saving calculation time. Furthermore, with this approach the process history and therefore the whole part geometry can be considered in the structural calculations. A validation of the transient temperature field and the mechanical part properties is presented by the comparison with measured values.

Introduction

Companies remain competitive in the future, if they manufacture industrial goods in shorter production cycles [1]. Hence, the customer demands regarding the production systems are changing. Prospectively, the use of production technologies that assure an economic production of parts in small quantities is important. Metal-based, additive processes, which are presented in this work, comply with the named requirements.

Based on a powder coat (different metals can be used), the part is solidified in single layers with a beam source (laser- or electron-beam). The layers are created directly from the CAD-Model, while using different interface formats. With lowering the building platform, the application of a new powder layer and the solidification process, the part is build up sequentially in the manufacturing system [2]. Further-more, the thermally activated, additive process causes high temperature gradients in the manufactured part. These gradients depend on the used exposure and coating time. The process-related temperature gradient mechanism (TGM) is causing distortions and residual stresses in the produced part. Hence, with an incorrect dimensioning of the production process, due to an incorrect choice of process parameters, the structural part properties can induce defects (eruptions, delamination) as well as direct failures during the manufacturing process (cp. error patterns in Figure 1).

Hence, for realizing a production without defective products, high process knowledge is demanded from the operator (cf. [3]). To achieve a stable and repeatable production, the application of digital tools (e. g. simulation) is of great significance for the economization of resources.

1 Simulation Models for Powder Coated Additive Processes

Different institutions and researchers work on the simulation of metal-based, additive manufacturing using the finite element analysis (FEA). Thereby, it can be distinguished between process-, material- and structural-simulation (cf. [4]). All three simulation disciplines exhibit different detail levels with regard to the process mapping and calculation of additive processes. Using the process simulation, the heat affected zone and thus the beam-material interactions can be mapped in detail.

For example [5] developed heat source models for additive manufacturing, to analyze the heat transfer during the application of the heat load. Furthermore, they examined the impact of a high beam source velocity on the stability of the welding seam within their simulation model. A similar investigation performs [6]. With the definition of equivalent heat source models in the simulation he analyzed the effect of the scanning velocity and beam power on the thermal part behavior.

Concerning the structural simulation, [4] and [7] developed technology-specific simulation systems for providing adapted simulation models to different user groups. Hence, single layers and layer-specific data are mapped within the developed layer-based model, whereas the calculation of the whole part geometry is realizable with using reduction strategies (summarization of layers, abstraction of scanning strategies) within the global-based model.

[14] present the demand of considering the material behavior in the structural simulation. [8] and [9] use temperature-dependent material models. Furthermore, [10] maps the powder coat in the simulation model with using a continuous medium theory and a local, isotropic and homogenous material behavior. The presented works demonstrate the need for an interdisciplinary connection between the simulation disciplines (structure, process and material) for a realistic mapping of metal-based, additive processes.

Hence, not only the used detail level has to be considered while applying loads and boundary conditions. On the contrary, this includes also the definition of the FE-geometry in the preprocessing of the simulation system.

Thus, [10] uses an element division which depends on the resulting temperature gradients.

This approach allows a refined meshing of the heat effected zone with cubic elements ($10\ \mu\text{m} \times 10\ \mu\text{m} \times 20\ \mu\text{m}$) and hence the application of a detailed heat source. Further FE-geometry elements are meshed with using an element size of $100\ \mu\text{m} \times 100\ \mu\text{m} \times 100\ \mu\text{m}$. In contrast [7] and [11] use different net shapes for different simulation models. While the global-based model exhibit an element size of $500\ \mu\text{m} \times 500\ \mu\text{m} \times 500\ \mu\text{m}$, $100\ \mu\text{m} \times 100\ \mu\text{m} \times 20\ \mu\text{m}$ elements are applied for the detail-based model.

These works are mostly regarding a static arrangement of the elements or are only usable within one layer. Furthermore, only model dependent process parameters can be analyzed. Due to the complexity of the production process, only layer specific process settings for single layers (cf. [12]), or layer overlapping parameters using reduction strategies can be confronted and rated (cf. [13]) at the same time.

2 Method-system for Creating User-specific Simulation Models

Metal-based, additive manufacturing processes require a variety of calculation steps with a detailed mapping of this technology by means of the finite element analysis. As mentioned in chapter 2, [7] enables the mapping of technology specific simulation models with using reduction strategies for an efficient calculation of the whole part as well as the detailed mapping of single layers. The received results are the initial basis for this work. However, for a simulation-based optimization of metal-based, additive manufacturing the advantages of a layered, dynamic adaption of the FE-geometry and the process boundary conditions should be used and summarized in a new research approach.

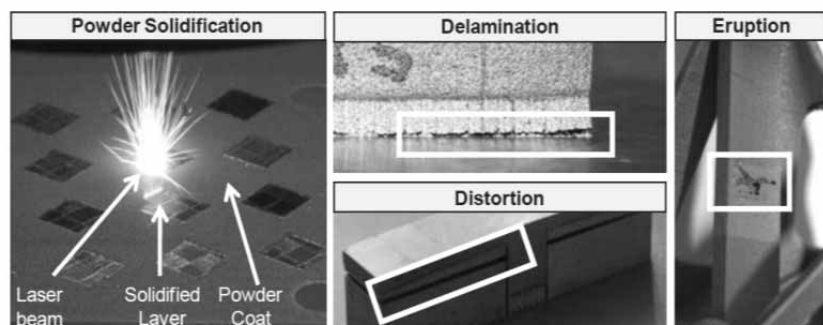

Figure 1: Powder solidification and typical error patterns of layered manufacturing.

By means of an abstract process model the calculation of the transient temperature field and thermo-mechanical values (residual stresses and distortions) should be performed with the option to detail every single layer in the mapping accuracy. This allows a layer-specific comparison of calculated dimensions. Furthermore, the user can choose between different detail and abstraction levels in future. This includes different modeling types for the scanning strategy, the support modeling and the merging of layers (cp. Figure 2).

Regarding the scanning strategy the heat flux during the solidification phase can be applied on single beam source vectors (so called hatches), using a distributed scanning pattern on single segments, or on the whole layer. The dimension of the process abstraction increases in this order. The unconsidered heat load distribution within a single layer should be regarded, when using a layer-specific exposure. By means of a twin-cantilever-structure (t-profile) with layer dimensions of 70 mm x 10 mm [11] verified the plausibility of this approach by comparing measured and simulated values. However, operators of additive manufacturing systems use distributed scanning strategies nowadays (cp Figure 2).

Thus, scanning vectors can be summarized to layer segments and are therefore suitable for a simultaneous application of the heat flux. Compared to a layer-specific exposure, this approach increases the calculation accuracy. Supports are used in the process for transporting heat from the above solidified layers and are supporting protruding part areas during manufacturing. Because these structures are not enhancing the appreciation of the product, these structures are mostly filigree and are consisting of single grid structures (cp. Figure 2).

Hence, the width of a solidified support bridge complies with the diameter of the beam source (LBB in Figure 2). A construction of an element mesh with 2½-D shell elements with 4 nodes is therefore sufficient. However, if mapping sheet metals as product geometry, the supports can exhibit a high degree of the total solidified vol-

ume. A detailed modeling of these structures is linked with a higher calculation effort. [7] analyzed the possibility of a continuum-mechanic mapping of supports in the structural simulation. This approach includes controlling the structural behavior of supports with the definition of ortho-tropic material properties.

Thus, factors that are calculated from the geometrical dimensions of support structures are multiplied with thermal (density, thermal conductivity) and thermo-mechanical (young's modulus, shear modulus) values of the solid material. [14] enhanced this approach, to regard further support geometries (e. g. with a web- or line pattern) (cp. $f_{sgx,y}$ in Figure 2). Thereby, the factors are calculated layer-specific, whereas the layer geometry is considered in the material adjustments for the support. The limit of this modeling type represents the support gapping. With increasing L_{GD} the Young's modulus decreases. This effect should be regarded if modeling a bilinear kinematic hardening. Small values for the Young's modulus can cause calculation convergence problems, when applying high temperature loads.

Nowadays additive manufactured parts can be produced with a height of 300 mm. 10,000 layers have to be solidified if the whole height and a layer thickness of 30 µm is used. It is not feasible to analyze all layers in detail due to the actual available computer architecture.

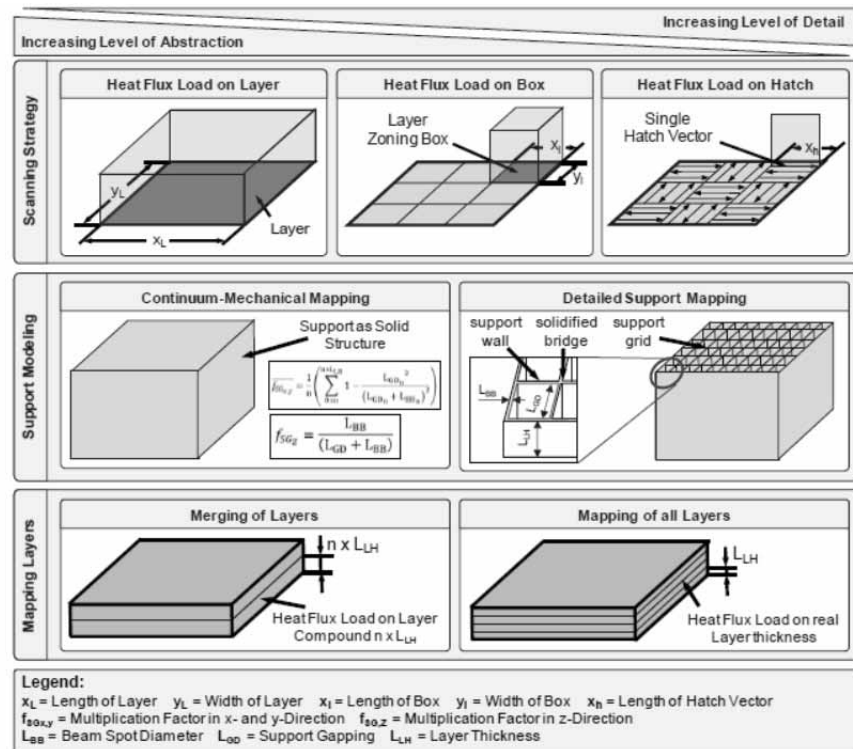

Figure 2: Modeling types for the structural simulation of layered manufacturing

This will cause enormous calculation times, especially if different process parameter adjustments are compared. Hence, merging of layers to layer compounds should be mapped within the element pattern and should be applied with a common heat source. The validation of this approach proofed also [11]. However, with large layer dimensions and a low amount of layers, the mapping of all layers is expedient.

The choice of the presented modeling types is dependent on the customer demands. The selection should be determined according to the product geometry and the analyzed target figure. In future, the combination of the modeling types visualized in Figure 2 should be possible. Furthermore, the user can change the abstraction and detail levels before solving the simulation problem. Single layers can be analyzed more in detail regarding the structural part's characteristics, whereas the remaining FE-geometry is calculated with a higher abstraction level.

The differences in the mesh topology can be equalized by different methods of mesh linking. Compared with the option "constraint equations" that should be applied on the surfaces of the layer meshes that have to be interconnected, contact element definitions allow a higher range of adjustment possibilities. The functionality of a dynamic detailing model is therefore demonstrated in the following by means of an application scenario.

3 Application of the Method - System for a Dynamic Detail Level

[11] and [15] used twin-cantilever structures for analyzing the structural part's characteristics. For establishing the same knowledge base and for the comparableness of the results, the geometry shape is taken as a basis for this research work. Due to the symmetry of this part, only one wing area is considered (cp. Figure 3). This allows a fast measurement value logging (cp. chapter 4) and the efficient solving of the simulation problem.

Following the abstraction and detail levels presented in Figure 2, two different modeling types were combined with contact definitions. The lowest layer of the wing area is representing a detailed process mapping, which allows also a particular support construction. Due to the distributed scanning pattern in this area, according to the specifications of the man-

ufacturing system control, a finer mesh of the geometry with $0,1 \times 0,1 \times 0,2 \text{ mm}^3$ is realized (cp. preprocessing definitions Figure 4).

The remaining layers are provided with a higher abstraction concerning the scanning strategy, the merging of layers to layer compounds and the continuum-mechanical mapping of supports. For a significant improvement of the calculation efficiency a mesh with $2 \times 2 \times 0,5 \text{ mm}^3$ is used. Hence, these two mesh topologies are joined with using contact elements (cf. Figure 3). As shown in Figure 4, "Surface-to-Surface" contact definitions are applied between the part models.

The support in the detailed process mapping is modeled with shell elements. Due to the corresponding geometry configuration "Node-to-Surface" contacts are used for joining the support areas. The detailed layer is positioned between layers of the abstract process mapping. Hence, a contact pair (consisting of contact and target elements) is defined on the bottom and top of the detailed layer (cp. Figure 3). The needed contact force for fulfilling the contact conditions can be calculated by multiplying the resulting stiffness with the contact penetration subtracted from the reverse acting, applied load (cf. [16]).

As shown in Figure 4, an exemplarily contact definition for the layer $n+1$ is performed to detail the mesh topology. On the basis of the thermal material data (cp. Figure 4) as well as the deposited layering gathered from the preprocessing definitions, the calculation of the transient temperature field can be performed. [17] and [18] describe therefore the thermal equilibrium equation. Additionally, the definitions of the contact junction can be adjusted with "keyoptions" of the corresponding elements. Hence, the amount of degrees of freedoms is set to temperature calculations. Because of the direct abutment of the contacts to volume or shell elements, only a heat transfer should be modeled. The corresponding thermal contact conduction is defined with (cf. [17] and [16]):

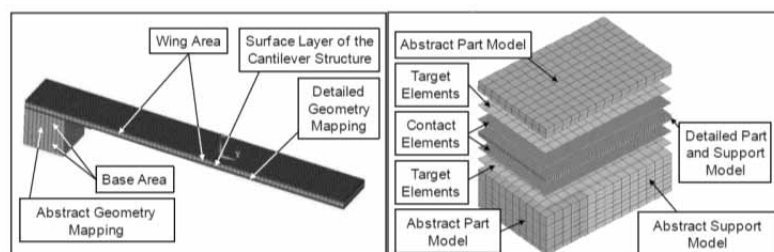

Figure 3: Cantilever structure and schematic sketch of coupling different detail levels.

$$\frac{\delta Q}{\delta \mathbf{x}} = K_c \left(\frac{\delta T_T}{\delta \mathbf{x}} - \frac{\delta T_C}{\delta \mathbf{x}} \right) \quad (1)$$

In this equation Q is defined through the heat flux that is calculated by the thermal equilibrium equation K_c , describes the thermal contact conductance coefficient T_T , is the resulting temperature at the target surface and T_C is the temperature at the contact surface.

In the mechanical analysis the temperatures as well as the assignment to nodes and times are the basis for these calculations. Regarding the used material data (temperature dependent stress-strain-relations, thermal dilatation and contraction) the structural part properties are solved by the dynamic transient equilibrium equation (cf. [18], [14] and [17]).

For the corresponding contact definition the ‘‘Augmented Lagrangian Method’’ is used (cf. [16]), after changing the degrees of freedom to distortions. The needed pressure for closing the contact is defined by following equation (cf. [17]):

$$P = \begin{cases} 0 & \text{if } u_n > 0 \\ K_n \times u_n + \lambda_{i+1} & \text{if } u_n \leq 0 \end{cases} \quad (2)$$

K_n describes the contact normal stiffness, u_n is the contact gap size and λ_{i+1} is defined by following correlation (cf. [17]):

$$\lambda_{i+1} = \begin{cases} \lambda_i + K_n \times u_n & \text{if } |u_n| > \epsilon \\ \lambda_i & \text{if } |u_n| < \epsilon \end{cases} \quad (3)$$

Hence, λ_i is the Lagrange multiplier component at iteration i and ϵ is the compatibility tolerance. Furthermore, with adjusting the contact ‘‘keyoptions’’ an adjustment of the contact status to ‘‘always bonded’’ is realized. That means, that the equation for $u_n \leq 0$ corresponds to $u_n > 0$. Due to the resulting layer compound in the manufacturing process this adjustment should be considered as useful.

4 Calculation and Measurement of the Transient Temperature Field

For verifying the modeling approach presented in Chapter 3, the comparison of calculated results with measured values is performed by recording thermal data from a thermal imaging camera. The transient temperature field is captured during the manufacturing of the cantilever (cp. Figure 3). Different from the simulation model, the abstraction levels are not active in production. Thus, the part generation in the manufacturing system corresponds to a detailed modeling in the simulation (cp. Figure 2).

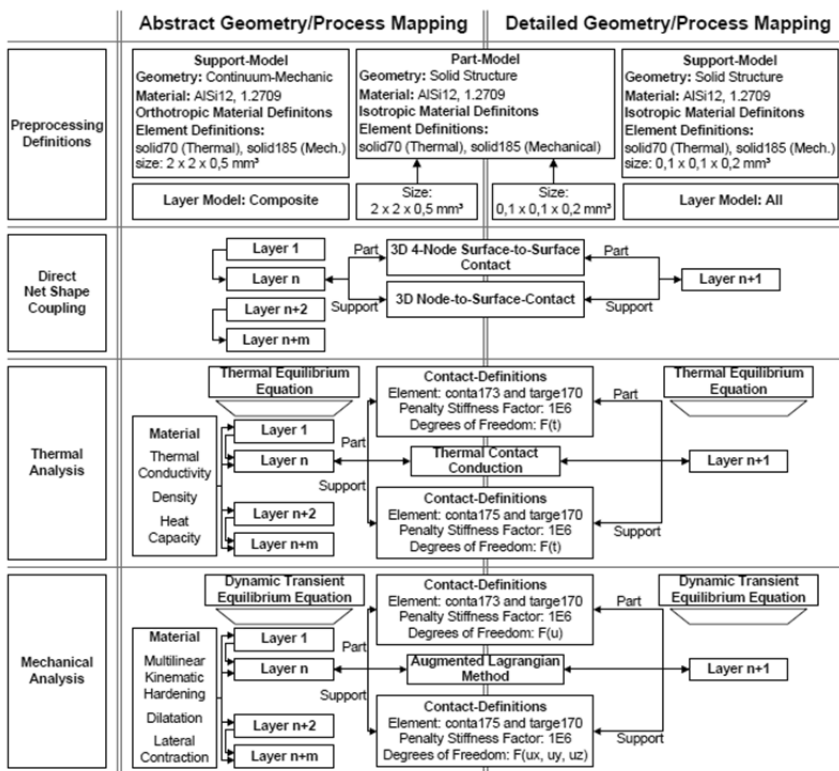

Figure 4. Procedure for the application of a dynamic model detailing.

This comparison allows proofing the validity of the used abstraction methods. Furthermore, the detailed layer in the simulation was also used for the measurements (cp. Figure 4). In the measurement field different measuring points named from P1 to P6 were de-fined. These correspond to the positions in the extracted simulation results. Figure 5 is displaying the temperature distribution and the graphs of the temperature profile at measurement point P1.

The curve shapes exhibit that the time course while applying heat loads are matching approximately. There is a peak recognizable at 5 s that is caused by the heat flux of the distributed scanning pattern. At this point of time the beam source (heat load) is directly at measuring point P1.

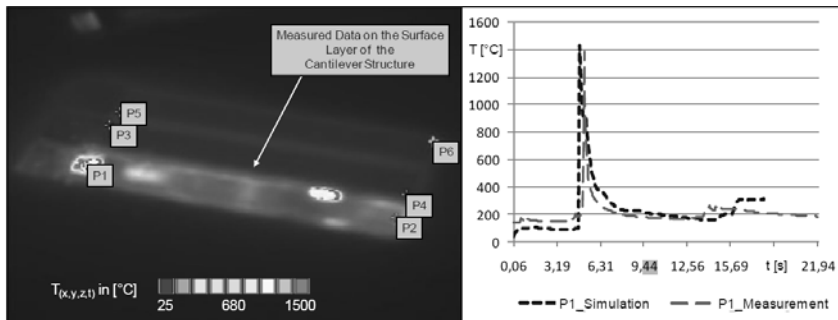

Figure 5. Comparison of the transient temperature profile using a cantilever structure.

The next local temperature increase between 13 s and 16 s indicate an exposure of a neighboring powder area relatively to the measuring point. The time offset between measurement and simulation at this point is caused by the element divisions. The heat load application can be performed more precisely if re-fining the element size, whereas the calculation time increases drastically. The offset of temperatures between both curves from 0 s to 5 s is caused by using a partially transparent germanium glass in front of the thermal imaging camera for the needed separation of the process from the environment. Nevertheless, with controlling the emission coefficient during the interpretation of the measured values a better alignment could not be reached.

5 Summary and Future Perspectives

Using metal-based additive manufacturing processes the operator is able to manufacture efficiently complex and individual parts. As shown in chapter 2, distortions and residual stresses are a result of the thermal activated process. The simulation based on the finite element analysis allows the optimization of the process before the production is started. This work presents a method for the dynamic coupling of different detail and abstraction levels in order to create the simulation model (cp. chapter 3).

Using this method the whole part as well as the distributed scanning pattern can be mapped with one simulation model. As shown by the application of the method with a benchmark geometry in chapter 4, the detail level can be increased in every single layer employing contact elements.

Hence, the user can choose between the presented modeling options in Figure 2. The results of the theoretical examination are verified by the comparison of the transient temperature field between simulation and calculation in chapter 5.

Further investigations with regard to the application of abstract process mapping should be performed using different product geometries to analyze the global applicability of the

methods. Furthermore, a comparison between measured and simulated results concerning the structural part behavior should be conducted. Therefore, measurements with neutron diffractometry (for measuring residual stresses) and optical measurement systems (for measuring distortions) are necessary.

References

- [1] M. F. Zaeh. *Wirtschaftliche Fertigung mit Rapid-Technologien. Anwender-Leitfaden zur Auswahl geeigneter Verfahren.* iwv Anwenderzentrum Augsburg, TU Muenchen. Muenchen. Germany, Hanser 2006. ISBN: 9783446228542.
- [2] A. Gebhardt. *Generative Fertigungsverfahren. Rapid Prototyping, Rapid Tooling, Rapid Manufacturing.* 3. Aufl. Muenchen, Germany: Hanser 2007. ISBN 9783446226661.
- [3] M. van Elsen. *Complexity of selective laser melting.* Ph.D. Thesis. Katholieke Un-versiteit Leuven 2007.
- [4] M. F. Zaeh, G. Branner, T. A. Krol. *A three dimensional FE-model for the investigation of transient physical effects in Selective Laser Melting.* In: Bártolo, J. P. (Hrsg.): *Innovative Developments in Design and Manufacturing - Advanced Research in Virtual and Rapid Prototyping (Proceedings of VR@P4).* London: Taylor & Francis 2009. ISBN: 978-0-415-87307-9.
- [5] A. V. Gusarov, I. Yadroitsev, P. Bertrand, I. Smurov. *Model of Radiation and Heat Transfer in Laser-Powder Interaction Zone at Selective Laser Melting.* Journal of Heat Transfer 131 (July 2009) 7, pp. 072101-1 - 072101-10.

Accepted ASIM SST Winterthur, September 2011

Submitted: September 2011

Accepted November 30, 2011

Integration of GIS Data in Health Care Utilization

Georg Romstorfer^{1,*}, Stephanie Parragh¹, Günter Schneckenreither^{1,2},
Michael Landsiedl², Patrick Einzinger², Martin Scheuringer³

¹Vienna University of Technology, Institute for Analysis and Scientific Computing, Wiedner Hauptstraße 8-10, 1040 Vienna, Austria; *georg.romstorfer@tuwien.ac.at

²DWH Simulation Services, Vienna, Austria; ³Main Association of Social Security Institutions, Vienna, Austria

Abstract The process of choosing medical providers for consuming health care services, highly depends on local properties like medical provider (e.g. physicians and hospitals) and population density or distances between single agents of these groups. As a consequence data containing geographical information has to be used. Obtaining, pre-processing and integrating this data into a dynamic model turns out to be a challenging task.

We present an agent-based dynamic model of Health Care Utilization that uses geographical data from two sources: Map data from OpenStreetMap for constructing the GIS-environment and raster data on population density from Statistics Austria. The presented model is held relatively simple as the main focus lies rather on the analysis of GIS data integration with agent based models of health care than on a valid mapping of health care utilization.

GIS data comes in various formats and one has to decide on a general format that can be used all over the model. We integrated all our data into a PostGIS database, where it can be easily maintained as all data can be found at a single location (in contrast to solutions with several data files). AnyLogic™ was used for simulation, but does not provide any means of displaying GIS information from a PostGIS database. As a consequence a class for displaying this information on a map had to be developed. It uses GeoTools for accessing the GIS enabled database.

As a result we show differences when modelling with and without GIS Data and give an outlook on future possibilities of simulation with geographically enhanced data.

Introduction

Modelling health care utilisation is a necessary task if one wants to raise the efficiency of hospitals or get information on the regional health care supply. Incorporating GISData into these models makes them more accurate but also adds more complexity.

Is it really worth the effort? There is no general answer to this question but the decision has to be made for each individual case. This paper will give a detailed view on which tasks have to be done to include GIS-Data into an agent-based model and show the differences compared to a model without geographical data. The used model is just a test model of patients utilising hospitals with simplified rules. These patients want to increase their life quality (e.g. get healthy) while hospitals want to maximise their performance (e.g. income, utilisation, patients' satisfaction). paragraph of a section or of a subsection, or for a paragraph with paragraph heading ('subsubsection'), in special cases in paragraphs directly after listings or figures, if it improves readability.

1 Model Description

The model is agent-based with two types of agents: patients and hospitals.

1.1 Patients

The health of the patients can vary from one to the other of the following states: healthy, sick1 or sick2. There are two different treatments which can cure these diseases. Treatment A cures disease 1 and treatment B cures disease 2 and if the patient is sick of disease 1 it doesn't cure him but it makes him feel better. Each patient's life quality is measured by 1 if he is healthy, which decreases if he gets sick or does not get any treatment and increases if he gets an appropriate treatment. If a patient gets sick he puts himself on the appointment list of the hospital and waits for his treatment.

The patient checks every week, if he gets some treatment and if not his satisfaction with the hospital decreases. The satisfaction decreases too, if the patient gets wrong treatments and therefore has to stay longer in hospital.

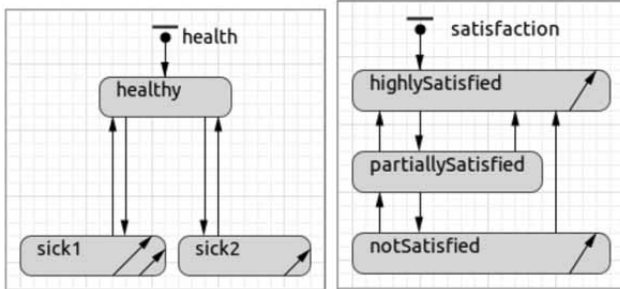

Figure 1. Patient's health states.

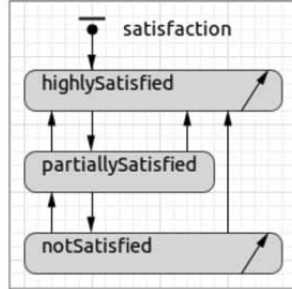

Figure 2. Patient's satisfaction states.

The data of the life quality of each patient is continually saved. Periodically each patient's mean life quality of the last period is compared to the life quality threshold. If the mean life quality falls under this threshold the patient becomes less satisfied and if the mean life quality gets much higher than the threshold he becomes more satisfied.

If the patient stays dissatisfied for a longer time he chooses another hospital. It is also possible, that the patient recommends a hospital to others if he his highly satisfied for a longer period.

Choosing hospitals. If a patient chooses a new hospital because he is not satisfied with his old one, he cancels his appointment and deletes his connection to the hospital. For each hospital the patient calculates a weight according to the following formula:

$$weight = \frac{(recommendations + 1) \cdot \ln(unitsPerWeek + 1 - treatments)}{(distance + 1)^2 \cdot \ln(unitsPerWeek + 1)}$$

Variable	Meaning
<i>recommendations</i>	number of patients that recommend that hospital
<i>unitsPerWeek</i>	number of patients that can be treated per week
<i>distance</i>	Distance to the hospital
<i>treatments</i>	Number of patients that get treatment in the hospital

If the distance is greater than a maximum distance the weight is divided by 1000 as a penalty. For the simulation with GIS-data the maximum distance was set to 60km and for the simulation without GIS-Data it was set to 100px.

A conclusion of Urach *et al.* [1] is that the willingness of patients to participate in a rehabilitation programme is inverse proportional to the *distance* to the rehabilitation centre. In our case there is a similar situation just with hospitals instead of rehabilitation centres. The result of testing out some reasonable inverse proportional functions was that inverse quadratic dependence of distance seems to be a good choice.

The ratio *unitsPerWeek* to treatments represents the utilisation of the hospital. If the hospital is running at normal operating capacity the ratio barely influences the weight but if the hospital is almost full (e.g. *treatments* equal *unitsPerWeek*) the weight decreases rapidly to zero. This dependence is best described by a logarithmic function of these variables.

Each *recommendation* increases the weight of the hospital. More recommendations lead to a higher probability of the hospital. After calculating these weights they are divided by their sum to get probabilities which sum up to 1. Then a hospital is randomly chosen with the calculated probabilities.

1.2 Hospitals

Each hospital maintains a list of appointments which holds patients waiting for treatment and a list *prolongedStays* which holds patients that have already gotten some treatment, but are not yet cured and therefore have to stay longer in hospital.

Hospitals are initialized with a certain number of beds from which the variable *unitsPerWeek* is calculated. This variable holds the number of patients that can be treated per week. The event *treat* is called *unitsPerWeek* times per week. Patients in the list *prolongedStays* are preferred over patients in the list *appointments*.

When the hospital treats a patient it has at first to decide on the type of treatment. Since the diseases have very similar symptoms, the hospital only knows a probability for the diseases. This probability is retrieved from a triangular distribution dependent on the actual patient's health state (Figure 3). Zero represents the actual patient's disease whereas 1 represents the other disease.

Then the hospital compares this probability to a threshold specific for each hospital. If the probability is greater than the threshold, the patient gets the wrong treatment else the right one. The health of the patient changes according to the health-statechart afterwards.

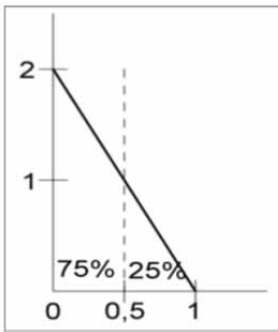

Figure 3. Triangular probability distribution for diseases with threshold at 0.5

The hospital adds the costs of the treatment to its income, increases its number of treatments and also increases the number of successful treatments, if the patient was cured.

Periodically the hospital adjusts the threshold for choosing treatments. The goal for the hospital is to find a good balance between successful treatments of the patients, high income and high utilisation. For accomplishing this the hospital calculates the following values for the adjustment period:

$$treatmentPerformance = \frac{successfull\ Treatments}{total\ Treatments}$$

$$utilizationPerformance = \frac{totalTreatments}{unitsperweek \bullet adjustmentIntervall}$$

$$incomePerformance = \frac{income}{total\ Treatments \bullet \max(treatmentCosts)}$$

Each of these values lies between 0 (bad performance) and 1 (good performance). The average of these values represents the *performance* of the hospital.

By comparing this performance to the previous one, the hospital decides how to change the threshold for choosing the treatment type. Initially the hospital increases the threshold by a specified amount until the performance of the last period is greater than the actual performance. Then it starts decreasing the threshold until the last performance is again greater than the actual one etc.

2 Obtaining GIS-Data

From the model we now know that distances between patients and hospitals have to be calculated when patients choose a hospital. For this calculation their positions have to be known. The ‘Main Association of Austrian Social Security Institutions’ [2] provided the addresses of public hospitals.

Positioning patients is the second problem. First of all it's not possible to get the address of every Austrian inhabitant, because of data protection. Secondly the model would take too much time to process about eight million patients. The solution was to use the MGI-Lambert raster [3] with associated population data [4] in combination with the permanent habitable area [5] to position one agent for every 1000 persons in the intersection area of a raster cell with the permanent habitable area. The map [6] where hospitals and patients are displayed was obtained from Geofabrik GmbH [7] which offer dumps of the OpenStreetMap [8] database.

3 Preprocessing GIS-Data

The obtained data came in very different formats listed in the following table:

Data	Format
Hospitals	Excel - Sheet
MGI Lambert raster	Shapefile
Population data	CSV - File
Permanent habitable area	Shapefile
Map	OSM – Dump (XML)

The decision was made to put all this data into a PostGIS [9] database. PostGIS is an extension to PostgreSQL [10] that adds support for geographical objects. So all that data had to be converted into that format.

The geographic coordinates for each of 126 hospitals was retrieved from the webservice Nominatim [11] and stored together with the address, number of beds and the name of the hospital in the database. When dealing with geographical data, not only the data format matters but also the coordinate reference system (CRS) in which the data is stored.

These coordinate reference systems describe how coordinates are assigned to points on the earth surface, which earth model is used (e.g. sphere, ellipsoid, ...), which units are used (e.g. meters, degrees, miles, ...) and how these coordinates get projected onto a map.

All the data was converted into the WGS84 [12] CRS that stores positions as pairs of latitude and longitude. For the display of our data the WGS 84 / Pseudo-Mercator [13] CRS was used, because it is widely used by web mapping and visualisation applications. The shapefiles were loaded into our PostGIS database and converted to WGS84 with opensource tools (Figure 4 and Figure 5).

The population data was imported into the database by SQL-commands which created a new table that contains the geographic raster cells associated with the population data, so that each row in this table holds the geographic boundary of the raster cell and the population that lives in that cell. Figure 4 shows each raster cell colored by its population size. With the map we processed as follows: At first an area of the European map was cut out large enough to contain the whole Austrian boundary. Afterwards the created OSM-file was imported into our PostGIS database. Reducing the data to the administrative boundaries was the last step and resulted in the actual data of interest (Figure 6).

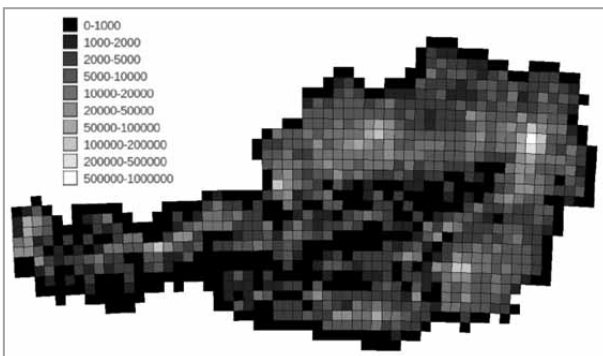

Figure 4. Raster with population density.

4 Integrating GIS-Data into the Model

The model was implemented in AnyLogic™. So this part will show how to integrate GIS-Data in that simulation environment. AnyLogic™ has some basic support for GIS-environments which means that agents can be positioned by latitude and longitude, distances can be calculated and shapefiles can be displayed as a map.

Unfortunately there is no support for PostGIS databases. The GIS-environment of AnyLogic™ works satisfactorily, so it was reused. The major problem was the map, that can just display shapefiles. Fortunately the map class *ShapeGISMap* derives from the abstract class *AbstractShapeGISMap*.

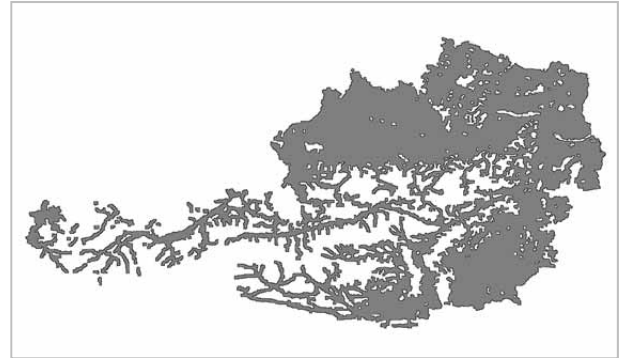

Figure 5. Permanent habitable area.

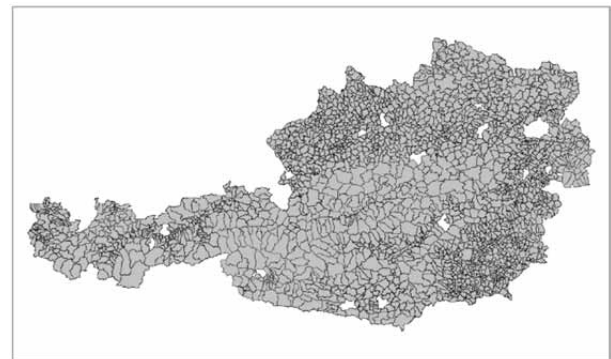

Figure 6. Austrian municipalities from OpenStreetMap.

So we derived our own map class *ShapeGeoTools-Map* that uses GeoTools [14] to access the GISData in the database. We also implemented the functions for calculating the distance between two points, zooming and panning and added some mouse event handling routines. The result is a fully integrated map that can be navigated by mouse like anybody is used to from well known web mapping applications. We added layers of the raster, the permanent habitable area and the Austrian municipalities. During simulation one can switch between these maps. The hospitals were initialized with their positions and the number of available beds, which we simply read from the database using the AnyLogic™ database connector. For each raster cell we uniformly positioned one agent per 1000 people in the intersection of that cell with the permanent habitable area. That gives us 7971 agents.

5 Calculating Distances

When calculating distances one has to take care which distance is meant: cartesian, geodesic or the length of the way from one point to the other. For our problem when calculating distances from a patient to hospitals

the way-distance would be most precise. Since calculation effort of way-distance is much higher than that for geodesic distance we did a comparison of these two distances based on our data to see how high the error would be, if we use geodesic distance instead of way-distance. The following table shows the comparison for 7971 patients and 126 hospitals. Distances were calculated from each patient to each hospital. Calculation of geodesic distances took less than 1 second whereas way-distances took 4 days. Way-distances were calculated by Gosmore[15] and the OSM-File containing the bounding box of Austria.

Calculation was done using an Intel[®] Core™ i7-2620M processor which features 4 2.7GHz CPUs and 4GB RAM. Since Gosmore took 2GB RAM at peak times only two instances could be run at the same time. The following table shows the results:

Average absolute distance differences	68205.95 m
Average relative distance difference	32.57%
Maximum absolute distance differenc	283631.17 m
Maximum relative distance differenc	179.35%
Equal nearest hospital	11.59%
Equal nearest hospitals (ordered)	3.15 hospitals
Equal hospitals in nearest 5	4.36 hospitals
Equal hospitals in nearest 10	8.83 hospitals
Equal hospitals in nearest 20	18.50 hospitals

We calculated the absolute distance difference between geodesic distance and waydistance for the distance between each patient and each hospital. The relative distance difference is the distance difference divided by the mean value of both distances. From these value we calculated the average and maximum.

The value of *equal nearest hospital* gives the percentage of patients that have the same nearest hospital at both calculation methods. The next value ist similar: Not only the nearest hospital is taken into account but also the following hospitals when ordered by distance. It gives the average number of nearest hospitals that match both calculation methods. The three last values give the average number of hospitals that are the same in the set of the first 5, 10 or 20 hospitals.

From these figures one can see that the difference between these two distances is high but the order of the hospitals when ordered by distance to a certain patient is preserved. And since the order of the hospitals counts when a patient chooses one of them, the absolute error does not matter that much.

6 Simulation Results

We built one model with GIS-Data and another one that also uses a spatial environment but positions patients and hospitals randomly to see where the differences are. The number of hospitals and patients and the number of beds in each hospital were the same in both models to make them comparable.

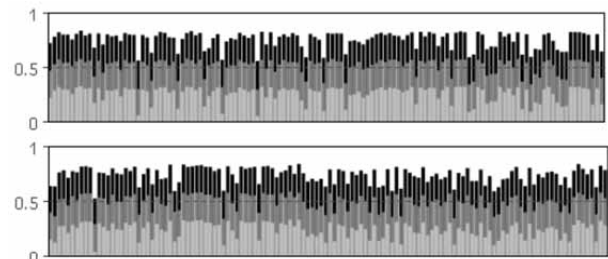

Figure 7. Average utilisation, income and treatment performance per hospital (without/with GIS-Data).

The comparison of the hospitals' performance charts (Figure 7) shows that there are hospitals with low performance in both cases. These lie on the border of the environment in case of simulation without GIS-Data and in areas with less population in case of simulation with GIS-Data. These hospitals can be clearly identified when using GIS-Data. Further analysis showed that the eleventh hospital in the right chart is too big (too many beds) for the area's population.

In the following figures we see the hospitals and the connecting lines to patients that are associated with each hospital. Here we can clearly see that GIS-Data has great influence on the distribution of hospitals as they are not uniformly distributed on the area. The next figures show the distribution of patients. Black patients have a distance greater than 60km/100px to their hospital while white patients live almost next to a hospital. Hence black areas could be a hint on missing hospitals.



Figure 8. Hospitals and connections to patients.

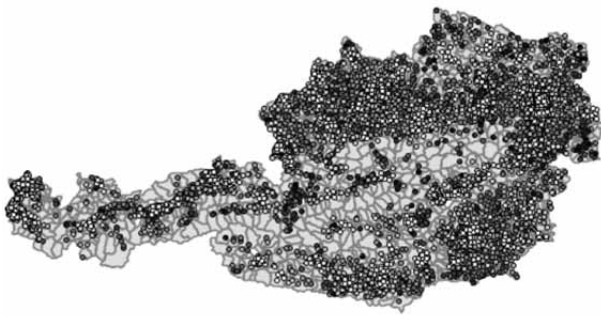

Figure 9. Patients coloured by distance to associated hospital

7 Conclusion

The integration of GIS-Data has a big impact on the simulation. Quite some effort is necessary for incorporating GIS-Data into the model. During simulation it mainly influences the distribution of patients and hospitals. Visualisations of the simulation take great advantage of the additional data. Further possibilities are regional statistics of any kind (e.g. health care supply or average distances per municipality). One could also assign different costs to treatments depending on geographic location or add other regional data.

References

- [1] C. Urach, F. Breitenacker, F. Miksch, N. Popper, I. Wilbacher, G. Zauner: *Distance Dependence on the Willingness of Patients to Participate in Ambulatory Heart Rehabilitation Programs*. Internal Report.
- [2] Hauptverband der österreichischen Sozialversicherungsträger, 18 July 2011, <http://www.hauptverband.at>
- [3] STATISTICS AUSTRIA – Geodata, 12 July 2011, http://www.statistik.at/web_de/downloads/raster/r10000m.zip
- [4] STATISTICS AUSTRIA – Statistical Grids MGI-Lambert, 12 July 2011, http://www.statistik.at/web_de/downloads/raster/r10000m_mit_daten_txt.zip
- [5] STATISTICS AUSTRIA – Geodata, 12 July 2011, http://www.statistik.at/web_de/downloads/geodaten/statistik_austria_04_dsr_sehrstarkgen.zip
- [6] GEOFABRIK Downloadbereich, 12 July 2011, <http://download.geofabrik.de/osm/europe.osm.bz2>
- [7] GEOFABRIK, 12 July 2011, <http://www.geofabrik.de>
- [8] OpenStreetMap, 12 July 2011, <http://www.openstreetmap.org>
- [9] PostGIS, 12 July 2011, <http://postgis.refractor.net>
- [10] PostgreSQL, 12 July 2011, <http://www.postgresql.org>
- [11] Nominatim, 18 July 2011, <http://wiki.openstreetmap.org/wiki/Nominatim>
- [12] EPSG::4326, 12 July 2011, http://www.epsg-registry.org/report.htm?type=selection&entity=urn:ogc:def:crs:EPSG::4326&reportDetail=short&style=urn:uuid:report-style:default-with-code&style_name=OGP%20Default%20With%20Code&title=EPSG::4326
- [13] EPSG::3857, 12 July 2011, http://www.epsg-registry.org/report.htm?type=selection&entity=urn:ogc:def:crs:EPSG::3857&reportDetail=short&style=urn:uuid:report-style:default-with-code&style_name=OGP%20Default%20With%20Code&title=EPSG::3857
- [14] GeoTools *The Open Source Java GIS Toolkit*, 13 July 2011, <http://geotools.org>
- [15] Gosmore, July 2011, <http://wiki.openstreetmap.org/wiki/>

Accepted ASIM SST Winterthur, September 2011

Submitted: September 2011

Accepted November 30, 2011

Agent-based Modeling and Simulation of a Pastoral-nomadic Land Use System

Patrick Kuckertz^{*}, Oliver Ullrich, Anja Linstädter, Ewald Speckenmeyer

University of Cologne, Pohligstraße 1, 50969 Cologne, Germany; *kuckertz@informatik.uni-koeln.de

Abstract. Almost half of Africa is covered by arid savannas, which are used as rangelands and are the source of livelihood for a vast population. To sustain pasture quality, degradation has to be avoided and efficient and sustainable land use strategies are needed. This paper describes the development of a simulation model representing the range management strategies of the Himba people in north-western Namibia. The model recognizes spatial factors and the impact of management decisions on ecosystem dynamics. The paper also describes the process of creating and validating a software application, and implementing the model.

Introduction

Savannas are a mixed grass-tree biome and one of the most important vegetation types for livestock farming worldwide. They cover approx. 33 million km² [2] and at least 35% of the South African subcontinent [19]. Their arid to semi-arid climate aggravates crop cultivation, which is why livestock keeping is often the source of livelihood for people living in these regions. Like in any other dryland, low rainfall, which is also highly variable in time and space, makes livestock keeping risky [3;4]. Today land degradation caused by climate change and over-exploitation posts another serious threat to livelihood security. Efficient and sustainable land use strategies adapted to highly variable and changing environmental conditions are thus an important tool to counter these effects [6;11].

The mechanisms of land degradation and the interactions between land use strategies and ecosystem dynamics are complex and not yet fully understood [7]. In this context, not only temporal dynamics but also the spatial heterogeneity of natural resources (forage and water) seem to be of crucial importance for management decisions [12]. In the past two decades, many studies have used modeling approaches to come to a functional understanding of sustainable management strategies in drylands [see review in 20].

However, the decision-making processes of local land users are still not adequately incorporated into models.

This paper aims to contribute to our understanding of land use strategies in arid ecosystems by integrating pastoral-nomadic mobility decisions into a spatially explicit model. As agent-based modeling and simulation is a promising tool for modeling decision-making and its feedback on natural resources in social-ecological systems [13], this approach has been chosen. The model is thus an example of an agent-based land-use model, which combines a cellular landscape model with agent-based representations of decision-making, integrating the two components through interdependencies and feedbacks between agents and their environment [15]. Specifically, our model represents mutual relationships between natural processes and cattle herd grazing on savanna rangelands in north-western Namibia, populated by the Himba people.

1 System Description

The pastoral-nomadic Himba people populate the Omuramba basin in north-western Namibia. Because of a long-lasting political and economical isolation and the geographic remoteness of the region [5], the Himba retained their local ecological knowledge of herd management. This is why data on herd population dynamics, vegetation dynamics and strategies of herd management – as a “good practice” approach – help to understand which aspects of herd mobility and social networks are central aspects of a sustainable management.

The Himba are an ethnic group of approximately 30.000 people who live for the main part in the Kaokoland area in Namibia’s Kunene province [4]. They have been living in this region as pastoral nomads for over 200 years. Cattle are not only their main food source but also status symbol, financial resource and medium of exchange.

The Himba community is organized in households representing clan structures consisting of 20 to 30 people who keep about 200 to 300 cattle. This paper focuses on the Himba living in the Omuramba basin. The intramontane basin is situated in the north of the Kaokoland region at the border to Angola and covers an area of ca. 40x40km (1.600 km²). About 70 to 100 people live in this area, the cattle stocking rate is about 2.5 TLU/km² (Tropical Livestock Unit = 1 cattle of 250 kg).

The arid Mopane savanna of the Omuramba basin is a typical vegetation for this region [1]. Due to high grazing intensity, the grass layer is dominated by annual grasses and forbs [9]. A dry and a rainy season alternate in the course of the year. Rainy season lasts from November to April, dry season from May to October.

The herd management of the Himba comprises season-dependent mobility between pastures to assure a constant fodder supply for the herds. It also serves to minimize soil and pasture degradation [14;18]. Herd movements and pasture use are coordinated by the Himba community, and contraventions are sanctioned [4;17].

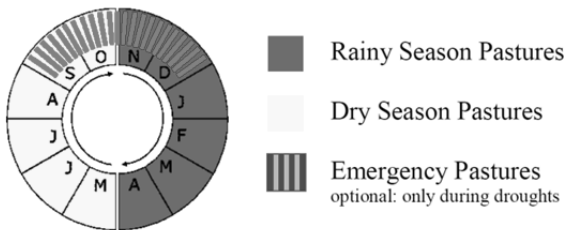

Figure 1. Annual herding cycle of the Himba [Source: 12].

A herd management applied within the last 50 years consists of typical seasonal movements of livestock across local pastures, which can be described as an annual herding cycle (see Figure 1). It is to let cattle herds graze on river side areas in rainy seasons and to move them to areas with boreholes which are situated far from rivers during dry seasons. In case of drought events access to specific pastures is given, which serve as fodder reserves and are not to be used in better years.

2 Modeling

The agent-based simulation model expands an existing spatially implicit model [14] by adding spatial aspects like topography, soil attributes, and the relative location of pastures and water sources. The influence of individual management decisions on the vegetation is reevaluated every day.

Landscape model	Precipitation model	Vegetation model
<ul style="list-style-type: none"> Capacity limit for green biomass [1] Soil depth [2] 	<ul style="list-style-type: none"> Amount of rain [3] Long-term influence on strategy [4] 	<ul style="list-style-type: none"> Interspecific competition of grasses [5] Short- to middle-term influence on strategy [6] Production of biomass [7] Mutual influence [8]
Pasture model	Herd model	Strategy model
<ul style="list-style-type: none"> Grazing pressure influences the cover classes [9] 	<ul style="list-style-type: none"> Biomass consumption [10] Cattle as food source, prestige, wealth; Population shrinkage through slaughter [11] Grazing and trampling [12] 	<ul style="list-style-type: none"> Determining the movements of herds [13] Strategy is chosen by the herdsmen [14]

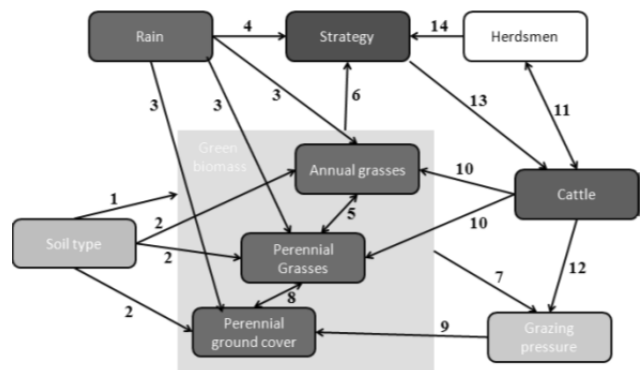

Figure 2. Submodels and their mutual influences.

An agent-based simulation model consists of agents, thus of attributes and of behavior determining rules, of an environment in which the agents move, and of their mutual influence [10]. The model introduced here is a composition of six submodels (see Figure 2) in which the environment is represented by a landscape, a pasture and a vegetation model. The hierarchical agents with their rules of behavior implement a herd and a strategy model. In the following section all submodels are described explicitly.

The landscape model provides the representation of the Omuramba basin. It subdivides the investigation area by a grid of 80x80 cells, each one representing an area of 500x500m (25ha). Each cell is assigned to a specific type of soil (see Figure 3). The 6400 cells are classified as follows: 1,765 cells (27.6%) belong to soil potentially used in rainy seasons, 2,546 cells (39.8%) to soil potentially used in dry seasons, 395 cells (6.2%) to soil reserved for droughts and 1,666 cells (26.0%) are classified as not usable. The properties of 26 cells (0.4%) are unknown.

Source of this allocation is a digital elevation model based on satellite images [12]. This model classifies the Omuramba basin into 6400 raster cells of 25 ha, and uses altitude, slope and flow accumulation calculations to determine certain spatial characteristics like accessibility, topography, relative position to rivers, and soil depth. To represent a pasture, a number of neighboring cells are pooled corresponding to maps and distance parameters.

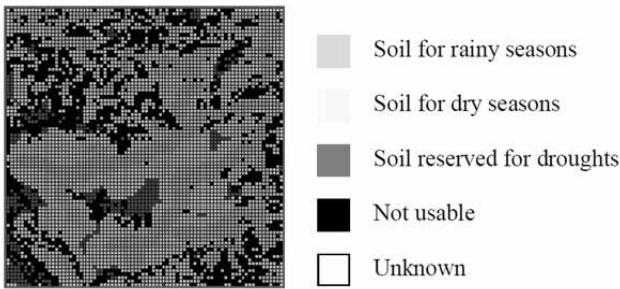

Figure 3. Landscape model of the Omuramba basin. The grid represents an area of 40x40km, and is divided into 6400 raster cells (25 ha each).

Class	Annual Rain Value $r(t)$	Probability
Drought	70mm	0,12
Below average	175mm	0,16
Average	280mm	0,43
Above average	385mm	0,29

Table 1. Classification of annual precipitation into classes, their mean value used for simulation, and their probability of occurrence [Source: 14].

Because of scarce data from the study region, precipitation is represented in a simplified model [14]. Annual precipitation data obtained from a nearby weather station are classified into four rainfall categories (see Table 1). At the beginning of each simulated year a random rain class is determined according to a probability distribution. Interannual dynamics are unknown and therefore randomized.

While a simulation step in the implicit model covers one year, the spatially explicit model has a daily resolution. To determine the daily amount of precipitation the annual amount of rain $r(t)$ (see Table 1) in the region is uniformly distributed among the 181 days of the rainy season.

Relevant aspects of vegetation dynamics are considered in the vegetation model. The modeled grass layer includes annual and perennial grasses. Annual grasses conclude their whole life cycle in a single vegetation period and outlast unfavorable seasons as seed in the soil. Perennial grasses cover the soil the whole year.

Plant growth is updated daily. It is determined by the growth functions (1) and (2) which use the amount of precipitation $r(t)$ and the degree in which the vegetation can make use of it [14]. This degree is termed as rain use efficiency (RUE).

Perennial biomass growth:

$$b_i^{per}(t) = RUE[sd_i, c_i(t)] \times r(t)$$

Annual biomass growth:

$$b_i^{ann}(t) = RUE(sd_i) \times r(t)$$

To calculate primary production of annual grasses b_i^{ann} (measured in kg dry mass per hectare) of a cell i , the RUE has to be determined in dependence of soil depth sdi (see Table 2). The RUE for perennial vegetation growth b_i^{per} depends on the type of soil and on the ground cover density c of grasses. A dense grass layer is more able to utilize precipitation more efficiently than a sparse one. Cover values are assigned to four classes, 0 standing for minimal and 3 standing for maximal cover. The determination of cover class c of a cell i in the year t depends on precipitation $r(t)$, soil depth sdi , the previous year's cover class $c_i(t-1)$ and grazing pressure.

The parameter grazing pressure provides information about how strong a cell has been exploited by cattle herds in the last year. It is measured by the ratio of grown to consumed and trampled biomass.

Because savanna environments do not provide infinite capacity for plants (biomass capacity for shallow soil: 1.5Mg/ha, for deep soil: 1Mg/ha), there is an interspecific competition between annual and perennial grass species. This competition is modeled by preferring the growth of perennial grasses and hence allowing them to occupy available space first. The natural plant decay is implemented by specific decay rates of plant groups (annuals and perennials). The biomass of perennial grasses monthly decreases by 5%, the biomass of annual grasses by 20%.

Additionally the annual grass biomass is set to zero at the end of the dry season because natural decay accelerates considerably with the onset of the first rains.

Herds are modeled as hierarchical agents. Herd agents choose a context-specific mobility decision out of a pool of principal decisions according to their rules of behavior. Their subsidiary agents represent groups of cattle, which move randomly over their dedicated pasture. For a change of pasture all groups reunite to a single herd and move to the new pasture.

Grazing offtake, i.e. the amounts of grass biomass consumed by cattle, depends on grass types' proportion of the total biomass of a cell (6.85kg per cattle and day).

Soil depth <i>sd</i>	Perennials				Annuals
	$c(t)=0$	$c(t)=1$	$c(t)=0$	$c(t)=0$	
Deep	0	3	4	4,8	2,78
Shallow	0	1,5	2	2,4	1,3

Table 2. Rain Use Efficiency of deep and shallow soils, and for perennial grasses and annual plants, in dependence of previous year's grazing pressure.

The loss due to trampling (about 10kg/day) is calculated likewise. The demographic herd development includes births (calving rate: 20% per year), age caused deaths and the slaughtering and selling of cattle.

```

Check at beginning of DS: if DSP provides enough fodder then go there else go to RFD
Check at beginning of RS: if RSP provides enough fodder then go there else stay on p
Check every day t: if p does not provide enough fodder then
  if p is RSP then
    if DSP provides enough fodder then go there else go to RFD
  if t is in RS then
    if p is DSP and (RSP provides enough fodder or DSP provides enough fodder) then go there else go to RFD
    if p is RFD and (RFD provides enough fodder or DSP provides enough fodder) then go there else increase PSC
  if t is in DS then
    if p is DSP then
      if another DSP provides enough fodder then go there else go to RFD
    if p is RFD then
      if DSP provides enough fodder then go there else increase PSC
if PSC >= 28 then die
    
```

Figure 4. Exemplary set of rules (p: current pasture, t: current day, RS: rainy season, DS: dry season, RSP: available rainy season pasture, DSP: available dry season pasture, RFD: available pasture reserved for drought, PSC: physical shape counter).

The physical shape of the cattle herds and subherds is modeled as a counter. If the current cell does not provide enough fodder for the group, the counter is incremented, otherwise stepwise decremented down to zero. The group is considered to be starved and taken out of the simulation when the counter reaches 28, because cattle can only stay without food for four weeks. The consequences of human behavior are integrated into the model through grazing management strategies. Human mobility decisions are the major aspect of this model, because of their great importance for ecosystem dynamics.

The patterns of pasture utilization are embedded into the agents' behavioral rules. They are designed to account for both foreseeable and unforeseeable environmental changes by appointing scheduled and unscheduled pasture alterations. An exemplary set of rules is shown in Figure 4. With the help of an additional set of simulation parameters, e.g. number and sizes of herds, potential vending options, or the level of stock reduction rates, the agents' strategy is further specified.

3 Implementation of an Agent-based Simulation Application

The designed model has been implemented in an interactive simulation tool to assess the effects of various pasture management strategies in an arid savanna ecosystem [8]. To support field operability the application should be platform independent and involve no license fees. For this purpose a visual simulation and analysis software has been developed in Java.

Experts are able to control scenarios through interactive parameter adjustments within the developed application. The simulation run is visualized through schematic views on pasture and vegetation models (see Figure 5). The application supports preliminary interpretation and evaluation of simulation results. It is possible to export data streams to auto generated Excel files to allow importing to statistical programs for further processing.

The cattle herds and groups are designed as hierarchical agents implementing the herd and strategy models. The agents move across a grid of cells according to their behavioral rules.

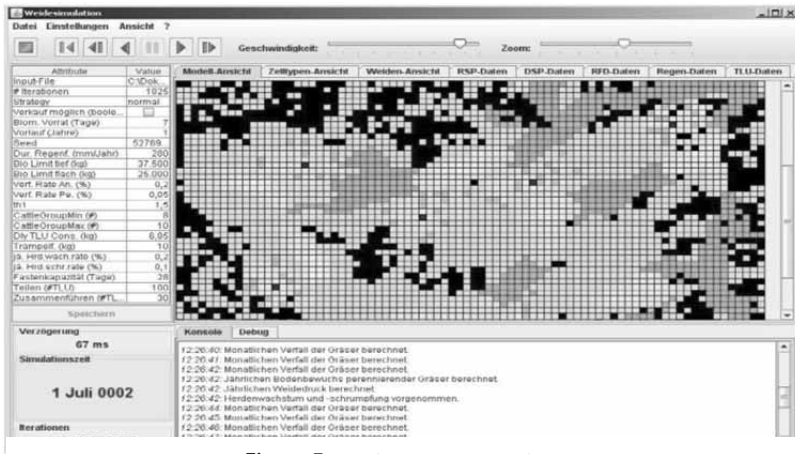

Figure 5. Application screenshot.

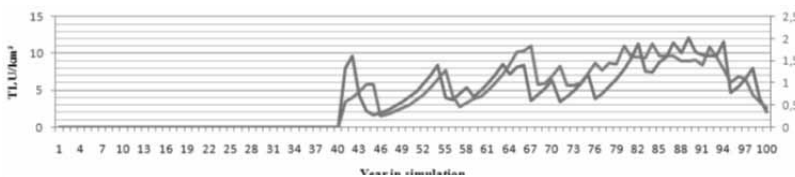

Figure 6. Comparison of herd population dynamics (red: spatially implicit model [14], blue: spatially explicit model).

This cellular automaton implements the landscape, precipitation, vegetation, and pasture models. The current states of the cells derive from environmental conditions (like precipitation and grazing pressure) and their previous states. Mutual influences of the cells due to their neighbourhoods do not exist. The agents interact with each other implicitly through occupying and grazing down the pastures. Interaction between the agents and the cellular automaton is expressed through grazing pressure and biomass recovery.

The evaluation of potential pasture management strategies has to be based upon reliable data. This is why close attention was paid to validating the models. Because of a lack of detailed datasets a data driven validation turned out to be difficult. Therefore function and theory based validation were applied. In the course of function based validation [10] the reactions of the submodels to given stimuli were tested and compared to the analytically expected behavior. The influence of chance was eliminated by replacing random values by predetermined values for a better comparison. Results show that biomass production corresponds with analytically expected values.

In the course of theory based validation simulation runs of the spatial explicit model were compared to those of the spatially implicit model with the same parameter configuration. It was shown that significant results like cattle population demographics concurred in tendencies (see Figure 6). The deviation in total numbers is caused by the different nature of the two models. In contrast to the spatial explicit model the implicit model makes no difference between potential and actually used pastures, and thus systematically overestimates cattle numbers.

In the implicit model the less significant dataset of the biomass composition of perennial and annual grasses is calculated with low accuracy in the event of heavy grazing pressure. Apparently the spatially explicit type of modeling is of significant effect in this case.

4 Conclusions and Further Research

Based on a spatially implicit model an agent-based model for analyzing pasture management strategies of the Himba people living in the Omuramba basin has been designed, implemented and validated. Through the explicit consideration of spatial effects, the impact of pastoral-nomadic management decisions on arid ecosystems can be modeled. In particular consequences of human behavior on the ecosystem of the region have been visualized by modeling pasture management strategies for the first time.

Some possible directions for further development are a more realistic handling of precipitation and a better representation of interspecific competition. Second, a revision of the herd model would allow cattle groups to move without being restricted by pasture boundaries and allow different herds to use the same pastures at the same time. This might converge to the classic swarm behavior of Reynolds [16].

In future work the consequences of different pasture management strategies will be analyzed and compared with the help of the simulation software. In an additional subproject the influence of social networks on the risk management in arid ecosystems will be studied.

References

- [1] T. Becker, N. Jürgens. *Vegetation along climate gradients in Kaokoland, North-West Namibia*. *Phytocoenologia* 30 (2000), p. 543-565.
- [2] D. J. Beerling, C. P. Osborne. *The origin of the savanna biome*. *Global Change Biology* 12 (2006), p. 2023-2031.
- [3] R. H. Behnke, C. Kerven. *Redesigning for risk: tracking and buffering environmental variability in Africa's rangelands*. *Natural Resource perspectives* 1 (1994), p. 1-7.
- [4] M. Bollig. *Risk management in a hazardous environment – a comparative study of two pastoral societies*. New York: Springer (2006), p. 1-324.
- [5] M. Bollig. *The colonial encapsulation of the north-western Namibian pastoral economy*. *Africa* 68 (1998), p. 506-535.
- [6] M. Bollig, A. Schulte. *Environmental change and pastoral perceptions: degradation and indigenous knowledge in two African pastoral communities*. *Human Ecology* 27 (1999), p. 493-514.
- [7] L. Gillson, M. T. Hoffman. *Rangeland ecology in a changing world*. *Science* 315 (2007), p. 53-54.
- [8] P. Kuckertz. *Entwurf und Entwicklung einer Anwendung zur Simulation des Weidemanagements des Volks der Himba in Namibia*. Diploma Thesis, University of Cologne (2010).
- [9] K. Leggett, J. Fennessy, S. Schneider. *Does land use matter in an arid environment? A case study from the Hoanib River catchment, north-western Namibia*. *Journal of Arid Environments* 53 (2003), p. 529-543.
- [10] Liebl, F.: *Simulation – Problemorientierte Einführung*. München, Wien: Oldenbourg Verlag (1995), p. 203f.
- [11] A. Linstädter. *Landscape ecology of savannas – from disturbance regime to management strategies*. In: Bollig, M.; Bubenzer, O. (eds.), *African Landscapes: Interdisciplinary Approaches*. New York, London: Springer (2008), p. 79-103.
- [12] A. Linstädter, A. Bolten. *Space matters – sustainable range management in a highly variable environment*. *Atlas of Cultural and Environmental Change in Arid Africa*. Cologne: Africa Praehistorica 21 (2007), p. 104-107.
- [13] R. Mathews, N. Gilbert, A. Roach, J. Polhill, N. Gotts. *Agent-based land-use models: a review of applications*. *Landscape Ecology* 22 (2007), p. 1447-1459.
- [14] B. Müller, A. Linstädter, K. Frank, M. Bollig, C. Wissel. *Learning from local knowledge: modeling the pastoral-nomadic range management of the Himba, Namibia*. *Ecological Applications*, Volume 17 (2007), p. 1857-1875.
- [15] D. C. Parker, S. M. Manson, M. A. Janssen, M. J. Hoffmann, P. Deadman. *Multi-agent systems for the simulation of land-use and land-cover change: a review*. *Annals of the Association of American Geographers* 93 (2003), p. 314-337.
- [16] C. W. Reynolds. *Flocks, Herds and Schools: A Distributed Behavioral Model*. *Computer Graphics*, Volume 21/4 (1987), p. 25-34.
- [17] H. Sander, M. Bollig, A. Schulte. *Himba Paradise lost. Stability, degradation, and pastoralists management of the Omuhonga Basin*. *Die Erde* 129 (1998), p. 301-315.
- [18] A. Schulte. *Stabilität oder Zerstörung? Veränderung der Vegetation des Kaokolandes unter pastoralnomadischer Nutzung*. *Kölner Geographische Arbeiten* 77 (2002), p. 101-118.
- [19] O. Solbig, E. Medina, J. F. Silva. *Biodiversity and Savanna Ecosystems processes. A Global Perspective*. Berlin: Springer (1996).
- [20] B. Tietjen, F. Jeltsch. *Semi-arid grazing systems and climate change: a survey of present modeling potential and future needs*. *Journal of Applied Ecology* 44 (2007), p. 425-434

Accepted ASIM SST Winterthur, September 2011

Submitted: September 2011

Accepted November 30, 2011

Cycle Time Analyses of Plants by Automated Modeling Techniques and DEVS

Robert Schoech*, Susanne Schmid, Christian Hillbrand

V-Research GmbH / Industrial Research and Development, Stadtstrasse 33, 6850 Dornbirn, Austria;

**robert.schoech@v-research.at*

Abstract. Planning, implementation and operation of plants are very costly and time-consuming processes. Due to parallel material movements, various possible combinations of the plant building blocks and because each plant is designed as a complete, customized system, the complexity of the plants can be enormous. For these reasons, a tool based on discrete event simulation has been developed, which allows the producer of the plants to model, emulate, simulate and animate the plant processes. This allows the system experts to make exact forecasts of the attainable cycle time. In this paper we describe the development of this automated modeling and simulation tool, regarding system architecture, processing of control system orders and task handling in the simulation environment. Finally, based on the findings of the realization and validation of the tool, this paper discusses the opportunities arising from this approach as well as its future potential.

Introduction

Cut-to-size plants with sorting and stacking solutions are very complex systems. Some of the characteristic problems are parallel material movement, buffer-areas and a large number of simultaneous activities. On cut-to-size plants several kinds of panels can be processed. The main cut-to-size processes are cutting, sorting and stacking. These processes are executed on machines like cut-to-size saws, sorting carriages, stacking devices, roller tracks, etc. In combination with their control unit, these machines are specified as self-contained plant units.

The acquisition, planning, implementation and operation of cut-to-size plants impose special challenges. Some of these can be traced back to the fact that a sales process usually takes place before the initiation of planning and implementation, since cut-to-size plants are built according to customer specifications (make-to-order strategy). Plant businesses show a high level of specialization of its product range and services [16]. In case of cut-to-size plants, performance is usually meas-

ured by cycle times. Besides that, there exist substantial information and knowledge asymmetries between suppliers and customers [16]. As the latter is not capable of evaluating the whole complexity of a plant, he needs to put a lot of confidence into the provider's projections concerning the performance and benefits of the plant.

An essential sales instrument of cut-to-size plants is the reputation of the provider company. Apart from this, reference plants are used to prove the technical feasibility and efficiency of the plants to the customers [18]. This is one of the reasons why the marketing of plants is a very complex organizational process which contains a considerable amount of risk for both parties. The supplier usually faces substantial sunk costs if the customer decides not to purchase the plant upon a rather extensive projection process. In order to reduce supplier-side risks, this paper describes a simulation-based approach to support the process from retail to operation and to make the distribution of cut-to-size plants more efficient. This planning instrument makes it possible for system experts to model, animate, simulate and emulate the cut-to-size processes without a need for any deeper simulation or emulation knowledge.

1 Theoretical Principles - Literature Review

Before providing details about the simulation approach for sales and projection processes, the following section will introduce some basic theoretical principles of simulation and emulation techniques. Based on that we will provide a review of the relevant literature within the field of discrete event simulation for decision support in industrial processes. As it will be discussed below, simulation techniques are likely to provide a wide range of analytical possibilities for planning and evaluating industrial processes. In the context of this paper, a future manufacturing process as designed in the sales phase can be considered as one specific industrial process.

In the literature, a variety of concepts and applications exist which are concerned with the application of discrete event simulation in Supply Chain Management (SCM). The application scenarios for this decision-supporting method are widespread in this case. They include to a large extent the general optimization tasks which are to be performed by SCM [2]. The target variables of simulation studies concentrate mainly on a reduction of cost, the optimization of material and information flows, the reduction of processing and lead times, or a consequent process-related orientation of the company [4]. A recent study analyzes over 80 articles which describe an application of Supply Chain Simulation either in an industrial pilot project, commercially available software, or a simulation test within a logistics chain [20]. This study shows that only 11 papers are concerned with manufacturing processes of which the vast majority aims at integrating the manufacturing process into the overall supply chain or scheduling of production lots. Only four papers describe scenarios for applying simulation for planning manufacturing layouts: Olhager and Persson describe the successful application of simulation for redesigning manufacturing plants in the electronics industry [15]. The other three articles are related to the simulation software package Supply Chain Builder (SCB) of Simulation Dynamics Inc. (SDI). The first approaches of SDI concentrated primarily on the intra-organizational optimization of value chains. The Plant Builder, for example, is focused on the simulation of internal value chain activities [19].

As an extension, the in-plant distribution as well as the supply chain on the distribution side is included in the simulation. Besides that, a number of articles report simulation studies in order to find optimal layouts for flexible manufacturing facilities [1, 3, 7, 33] or cellular manufacturing layouts [9, 14]. These approaches mostly aim at the (near) optimal solution of a specific problem rather than evaluating a multidimensional scenario like the assessment of feasibility for a future manufacturing plant projection.

By contrast, the starting point for optimizing the sales process is the definition of critical performance indicators (e.g. certain lead or cycle times) which have to be realizable by a projected facility or plant. Subsequently, the main issue is to identify admissible and feasible plant configurations which optimize these performance variables. As this paper will show, discrete event simulation can very efficiently support this task.

Emulation is the virtual reproduction of certain aspects of hardware or software systems (external system) on another system (host system) [13]. Therefore emulation can be seen as a special case of simulation, supplemented with the coupling of real functional components. For emulation of cut-to-size plants, job data is generated within a 'virtual plant', processed by the simulation tool.

Classical plants are centrally and hierarchically controlled real time systems (see Figure 1) [8]. On a real system the *field layer*, which constitutes the lowest level, represents all mechanical components with their actuators and sensors and controls the material handling. The *control layer* resides above the process level. On this layer, sensor data is processed and control signals for the actuators are generated. This level represents the basis for an automated, unit based plant. Moreover, it coordinates the handover of load data and controls the material flow of the plant units. The *process control layer* is the highest layer in the control pyramid and is usually called *plant server*. The *control layer* and the *process control layer* are connected by means of a communication channel, which passes on the scheduled orders to the *control layer* and receives confirmation when all actions have been processed.

The plant logic of the real time system as described above is mapped to a model within the virtual plant: The *virtual field layer* of the emulated system visualizes all mechanical components and displays the kinematic movement of the material handling in a virtual view. The *virtual control layer* prepares all orders from the *process control layer* and controls each virtual plant unit. Since there is a tight coupling between real time and simulation systems this system can be viewed as an emulation system [12].

2 General Design Principles

The following chapter provides a general overview of the system architecture for our simulation-based decision support approach. Also, the modeling process and the clear separation of virtual control layer and virtual field layer are discussed. Furthermore, our task handling method for event lists will be described. The application platform of our simulation based decision support system provides simulation libraries with generic modeling functions, which can be used to implement domain-specific modeling environments. A number of domain-specific modeling methods and applications, such as planning of transportation networks or warehousing

structures, have already been implemented upon this platform [5]. As one part of the described platform, specific methods for cut-to-size plants were implemented.

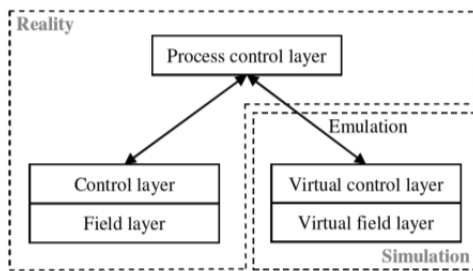

Figure 1. Central, hierarchical control systems.

The main intention has been to enable domain experts (i.e. technical sales personnel) to define alternative projected plant configurations within the virtual system and to evaluate them according to the predefined critical performance indicators in order to identify an optimal solution. By using a domain-specific modeling environment with an underlying simulation model built-in, the domain expert can take advantage of emulation techniques without need of simulation expertise. Therefore, the software architecture of the decision support system for cut-to-size-plants is arranged in two levels (see Figure 2).

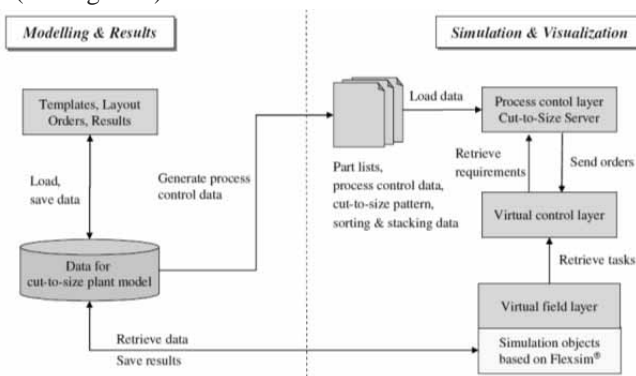

Figure 2. Software architecture for decision support system.

The *Modeling and Results Level* is used for the development of unit-based models [21] in which a plant is designed as a collection of plant units. The modeled plant is persisted and process control data for the cut-to-size server is generated automatically.

Depending on this process control data, bills of materials, batch sizes, optimized cut-to-size patterns, sorting and stacking patterns for panels are then computed. The computation results represent the planning data used as a basis to generate the orders for the virtual plant. Furthermore, the simulation run and the visualization of the

material flow are triggered at this level. Out of the orders, which are broadcasted by the cut-to-size server, *task sequences* are created (see Figure 3). A single task describes an activity that imitates the physical mechanism which is executed on the simulation object.

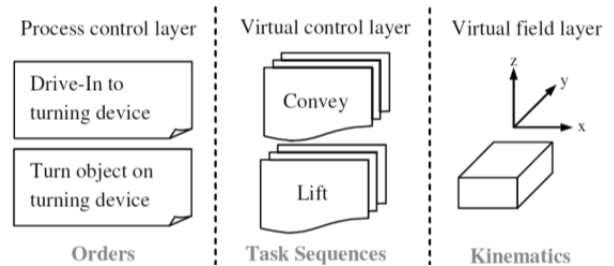

Figure 3. Order handling.

The *Simulation and Visualization Level* represents the virtual system, which is controlled. It is based on the simulation engine Flexsim®. Depending on the model data and associated meta-information, the simulation model is created automatically. After the initialization and start of the emulation model, the *virtual field layer* receives the *task sequences*, which are created on the *virtual control layer* and transforms them into discrete events. According to these tasks, kinematic flows are created (see Figure 3) and run time information is logged simultaneously.

Our approach to model large-scale plant systems is based on three complementary services (see Figure 4).

A *plant unit template* represents a self-contained plant unit, which consists of a set of devices. The collection of devices can be viewed with the *template designer*. A device is specified by attributes which describe process- and mechanical information, velocities and meta-information for the instantiation of each class type used in the *virtual field layer* and the *virtual control layer*. They cannot be broken down further.

The *graphical editor* uses the previously described *plant unit templates* and allows the user to instantiate the plant units using drag-and-drop and to couple the material flows using a snap function. Once the model is specified as a *unit-based system model* it needs to be transformed into a simulation model.

Therefore, the *unit-based system model* is persisted as a well-formed XML document. The transformation process to build a *simulation model* is automated and consists of three parts: The instantiation of the *virtual control layer* the creation of all simulation objects and the assignment of values to all public properties.

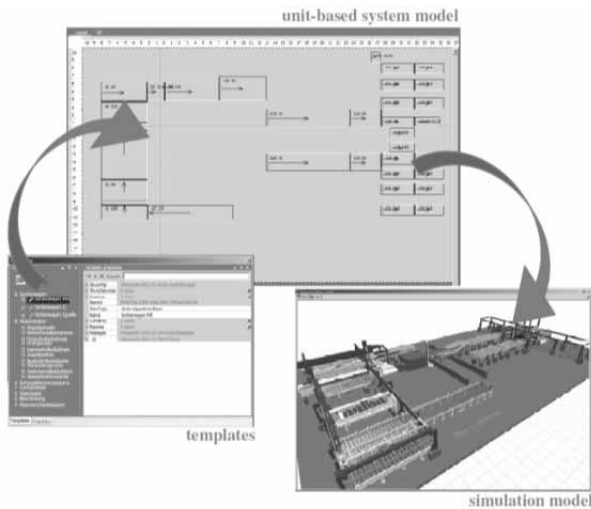

Figure 4. Simulation services.

The object-oriented hierarchical simulation model of the plant is based on the functional decomposition approach. The simulation includes the modeled units of the real plant and each unit of a production set is uniquely identifiable and traced during its lifecycle. The model is created according to the modeling process described in the previous section.

After starting the emulation the event list will be served through plant units of the *virtual control layer*. When the *process control layer* sends orders to designated plant units of the *virtual control layer*, all activities are registered as tasks and are stored in the event list in the correct order. The instruction set consists of 22 commands of three types: basic commands, motion commands and item operations.

Basic commands are generally used by the model to handle items. Motion commands describe the kinematic behavior of a plant unit or device. Item operations relate to a panel, respectively parts of a panel. The implementation of a *blocking rendezvous* pattern [6] for handling the event list makes it possible to have a simulation model in which the behavior is independent of simulation speed. If the *virtual field layer* confirms the execution of a task sequence, the confirmation call is blocked until the *process control layer* has sent new orders to the destination *plant units*. The elapsed time up to the confirmation call is skipped and will not be counted towards simulation time. This is because in real-time, the system which is controlled, has no time delay between order confirmation and receipt of orders. So, the connection between simulation model and the *process control layer* allows logging of system states and measurement of the performance of the emulated system's cycle time.

While running the simulation or emulation model, results are written to an Oracle® database which afterwards can be viewed and analyzed by the user through the application platform. On the *virtual field layer* of the simulation system, two kinds of information are logged:

- The information whether a device is *busy*: The status of a device is *busy* if it is moving in some direction (turning, opening, closing, etc.).
- The information whether a plant unit is *occupied*: The status of a plant unit is *occupied* if a flow object is located on it.

With these recorded information several sorts of result analysis can be carried out. These results are shown in tables and charts. The user has the possibility to group the displayed information by devices, plant units or regions of the plant units. Additionally it is possible to compare several simulation or emulation runs. With these options the user is able to analyze throughput rates and cycle times (see Figure 5) as well as utilization of plant units and devices of the cut-to-size plants.

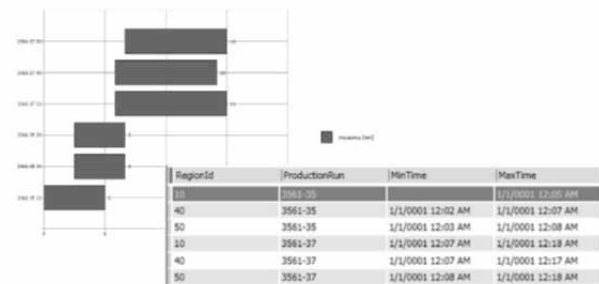

Figure 5. Analysis of cycle time of simulation runs.

3 Model Validation

For the verification and validation of emulation models, special aspects have to be taken into account [17]:

- an enormous exchange of data based on orders has to be established in an adequate way between the real process control layer and the simulation model,
- if the simulation model is particularly developed for emulation, the model cannot be tested autonomously,
- there are interactions with the development of the real control system.

For these reasons the verification and validation of the described emulation model is realized on two different levels: the validation of the plant server communication and the validation of the model execution. The applied techniques are described in the following chapter.

The main challenge with the implementation of an emulation model lies in the establishment of an ade-

quate communication between the process control layer and the virtual control layer. In the realized system, the broadcasted orders from this layer are transformed into task sequences, containing several single tasks that can be executed on the virtual control layer (see figure 3).

The most important requirements are the correct order sequence and the order confirmation at the right time. Depending on the order confirmation, new orders are triggered for processing next task sequences. The implementation of a blocking rendezvous pattern ensures that these rules are adhered to.

To be able to validate the correct order sequence, a Fixed Value Test will be applied to verify the deterministic model properties [17]. The emulated system's cycle time, for example, will be measured independent of simulation speed. The emulation model cannot be executed autonomously which makes the validation process even more complex and time-consuming. In the verification and validation process of the model execution several validation techniques [17] were applied like described below. First of all, *animation* of material flows and cut-to-size processes in 3D was used to verify the behavior of the plant. In the current application the visualization of the plant processes plays an important role, due to the fact that the decision support system will be applied as acquisition tool to demonstrate virtual cut-to-size plants to future customer.

For this reason, extensive effort was taken to visualize plant units and the contained devices with graphical data files (.vrm) which were generated directly out of the CADSystem of the manufacturer. Nonetheless, when using animation for model validation, it has to be considered, that it cannot guarantee a valid or debugged model [11]. Still it can be used to demonstrate non valid situations [10] and especially helps system experts to more easily understand the simulated processes and associate them with the processes of real cut-to-size plants. Based on the animation of the processes, *structured walkthroughs* were carried out with participation of the simulation experts who implemented the model and system experts who have detailed knowledge of cut-to-size processes. The purpose of this procedure was to go through the execution of tasks of each single plant unit and identify mistakes, irregularities and problems within these processes. During these walkthroughs the experts were supported with *operational graphics* in form of displayed transportation speeds and cycle times (e.g. saw cycle, feed cycle, etc.). Related to the presentation of these performance indicators at a certain point

of time, is the observation of values in the course of time which can be done within the result analysis of the simulation runs (see Figure 5).

Currently, effort is put in the validation of emulated cut-to-size plants in direct comparison to real plants. The foundations for such *historical data validation* can be fulfilled as cut-to-size runs on real system can be logged. Also the modeling of these real cut-to-size plants into a corresponding emulation model can be realized in an easy way. Still there are some requirements in the preparation of the logged data, which allows a direct comparison of real and virtual plants

4 Results and Findings

The implemented simulation and emulation tool provides the experts with relevant information, models and methods for the acquisition, the planning as well as the operation of cut-to-size plants. The tool facilitates the anticipation of the behavior of real plants on a virtual system and allows plant experts to model, simulate, emulate and animate sequences of cut-to-size plants without being experts in simulation or emulation.

When building up an emulation model, plant units like sawing, sorting or stacking machines are put into a model and linked together according to the modeling process described in the previous chapters. By running the emulation job, data of the virtual machines are generated on the host system, processed in the emulation model and results are written to the database. Subsequently the analysis of cycle times, throughput and utilization of the plant units can be realized by the means of tables and charts. The application of the decision support instrument brings various advantages in several phases of the selling and realization of cut-to-size plants.

First of all, by using the decision support tool in the acquisition process vendors of cut-to-size plants can more easily demonstrate the plant concepts, which will help the customer to understand the facts. Especially the animation of material flow helps the user to get a clearer idea of the processes on cut-to-size plants. The possibility of calculating exact cycle times, throughput rates and utilizations of machines improves the accuracy of prediction of performance specifications. Therefore technical expertise, steadiness and reliability can be demonstrated through virtual plants. With this approach costs and time can be saved in the acquisition process. Apart from this, the tool supports the system experts in the plant planning process, in validation of control strate-

gies and in the analysis of bottlenecks in the material flow. The comparison of several simulation scenarios is also possible and allows the system experts to constantly optimize the hardware and software. During implementation of the plant the tool can serve as training instrument to get familiar with the control system and plant processes. While operating the plant it is possible to perform impact analysis of modifications of the virtual as well as the real system. This allows an efficient analysis and resolution of errors without disrupting the normal course of business. With the realization of the described decision support tool a planning instrument could be developed which makes it possible to reduce acquisition and startup times for cut-to-size plants and continuously test and optimize the processes.

Currently the operational use of the implemented simulation-based decision support instrument is being initiated in one company. The concerned specialist for cut-to-size plants was directly involved in the realization process of the simulation and emulation systems.

Additional activities in the further development and extension of the emulation tool are planned in course of this year. Currently the machine units can only be tested separately and not as a combined plant system. The idea is to create a complex system where a combination of reality and simulation (see figure 1) can be achieved. This would mean that real units of the plant could be tested within the whole virtual system. This approach will help the plant experts to be able to find failures on machines or in the material flow much earlier as without the decision support tool.

References

- [1] E. E. Aleisa, L. Lin. *For effectiveness facilities planning: Layout optimization then simulation, or vice versa?*. In Proc. 2005 Winter Simulation Conference, 2005.
- [2] G. Archibald, N. Karabakal, P. Karlsson. *Supply chain vs. supply chain: using simulation to compete beyond the four walls*. In Proceedings of the 1999 Winter Simulation Conference, pp. 1207-1214, 1999.
- [3] F. Azadivar, J. Wang. *Facility layout optimization using simulation and genetic algorithms*. International Journal of Production Research, 38(17), 4369-4383, 2000.
- [4] J. Banks, S. Buckley, S. Jain, P. Lendermann, M. Manivannan. *Panel session: opportunities for simulation in supply chain management*. In Proceedings of the 2002 Winter Simulation Conference, 2, 1652-1658, 2002.
- [5] M. Dobler, M. Saler, L. Maerz. *Distribution of Concurrent Simulation Runs on a Service-oriented Network Structure*. Paper presented at the ASIM Conference 2008, Berlin, October 1 – 3, 2008.
- [6] B. P. Douglass. *Real time UML: advances in the UML for real-time systems*. Addison-Wesley, 2004.
- [7] G. R. Drake, J.S. Smith, B.A. Peters. *Simulation as a planning and scheduling tool for flexible manufacturing systems*. Proc. 1995 WinterSim Conf. pp.805-812, 1995.
- [8] W. Guenther, M. ten Hompel. *Internet der Dinge in der Intralogistik*. Springer Verlag, Berlin, 2010.
- [9] M. A. Irizarry, J.R. Wilson, J. Trevino. *A Flexible Simulation Tool for Manufacturing-cell Design*. IIE Transactions 33(10), 827-836, 2001.
- [10] A. M. Law. *Simulation Modeling and Analysis*. Mc Graw-Hill, Boston, 2007.
- [11] A. M. Law, M. G. McComas. *Secrets of successful simulation studies*. In: B. L. Nelson et al. Proc. 1991 Winter Sim Conf. IEEE, Phoenix (USA). 21-27, 1991.
- [12] I. Mc Gregor. *The relationship between simulation and emulation*. In Proc. 2002 Winter Simulation Conference, San Diego, California, USA:1683-1688, 2002.
- [13] P. Mertens. *Lexikon der Wirtschaftsinformatik*. Springer Verlag, Berlin, 2001.
- [14] J. S. Morris, R. J. Tersine. *A Simulation Analysis of Factors Influencing the Attractiveness of Group Technology Cellular Layouts*. Management Science 36(12), 1567-1578, 1990.
- [15] J. Olhager, F. Persson. *Simulating production and inventory control systems: a learning approach to operational excellence*. Production Planning and Control, 17 (2), 113-127, 2006.
- [16] S. Pekrul. *Bauwirtschaft und Baubetrieb. Strategien und Maßnahmen zur Steigerung der Wettbewerbsfähigkeit deutscher Bauunternehmen*. Univ.Bibliothek, Berlin, 2006.
- [17] M. Rabe, S. Spiekermann, S. Wenzel. *Verifikation und Validierung für die Simulation in Produktion und Logistik*. Springer-Verlag Berlin, Heidelberg, 2008.
- [18] A. Soellner. *Einführung in das Internationale Management. Eine institutionenökonomische Perspektive*. Gabler GWV Fachverlage GmbH, Wiesbaden, 2008.
- [19] A. Siprelle, D. Parsons, R. Phelps. *SDI Industry Pro: simulation for enterprisewide problem solving*. In Proc. Winter Simulation Conference, 241- 248, 1999.
- [20] S. Terzi, S. Cavalieri. *Simulation in the supply chain context: a survey*. Computers in Industry, 53 (1), 3-16, 2004.
- [21] B. P. Zeigler, H. S. Sarjoughian. *Introduction to DEVS Modeling and Simulation with JAVA: Developing Component-based Simulation Models*. Arizona Center of Integrative Modeling and Simulation, 2003.
- [22] M. C. Zhou, K. Venkatesh. *Modeling, simulation, and control of flexible manufacturing systems: a Petri net approach*. World Scientific Publishing Company, Singapore, 1999.

Accepted ASIM SST Winterthur, September 2011

Submitted: September 2011

Accepted October 15, 2011

Dynamic Distributed Simulation of DEVS Models on the OSGi Service

Martin Petzold*, Oliver Ullrich, Ewald Speckenmeyer

Department of Computer Science, University of Cologne, Pohligstraße 1, 50969 Cologne, Germany;
*petzold@informatik.uni-koeln.de

Abstract. Interoperability among simulators is one of the key factors in distributed simulations. Several interoperability infrastructures such as HLA and DEVS/SOA have been utilised, but most of them do not provide any dynamics. This paper introduces the use of the OSGi service platform as universal middleware for dynamic distributed simulation of DEVS models. We have designed and implemented the DEVS/OSGi simulation framework, which is an approach similar to DEVS/SOA, but relies on an integrated service-oriented and protocol independent architecture. It enables standardized plug-and-play capabilities and dynamic reconfiguration within distributed simulations. The architecture and implementation has been validated in an analytical context against a traffic simulation model. We conclude that the standardized interoperability and run-time dynamics provided by the OSGi service platform are highly valuable for distributed simulations.

Introduction

Distributed simulations (DS) are used in the context of analytical simulations for the analysis or forecast of the behaviour of a real or imaginary system [6]. In this case detailed quantitative data is collected and simulation runs are typically executed as fast as possible. Further, DS have been applied in distributed virtual environments (DVE), such as Second Life™. In this case the simulation embeds human participants or physical devices and simulation time advances usually in real time. For DVE the need of system accuracy is usually lower than in analytical simulations. In both domains interoperability infrastructure enables geographically distributed execution and the integration of heterogeneous simulators. Next to proprietary protocols more abstract interoperability infrastructures such as HLA and DEVS/SOA have been utilised for DS of DEVS models [9, 15]. However, in recent work [8, 14] a lack of standardization for plug-and-play capabilities and a need for research on dynamic reconfiguration in distributed simu-

lations has been identified. This should be adopted on an abstract architectural level and possibly also within the simulation nodes.

The DEVS/OSGi simulation framework introduced in this paper addresses both issues. The DEVS standard for modelling and simulation of discrete event systems is being mapped to the OSGi service platform, a widely used industrial standard for modular and dynamic applications in Java. The standardized run-time dynamics and service-oriented (distribution) concepts of OSGi enable plug-and-play capabilities for distributed simulation. Furthermore dynamic reconfiguration within the distributed simulation environments becomes possible.

In chapter two both standards (DEVS and OSGi) will be introduced, followed by a short overview over recent work in this context. In chapter three we will present the architecture and implementation of the DEVS/OSGi simulation framework. This is followed by some experiments using a traffic simulation model. Finally, some conclusions are drawn and issues for further research are highlighted.

1 Background

1.1 The Discrete Event System Specification (DEVS)

The Discrete Event System Specification (DEVS) is a modular and hierarchical system formalism that was introduced by Bernard P. Zeigler in 1976 [16]. DEVS models consist of atomic and coupled components. Atomic components define a specific behaviour of an entity that is being modelled. Whereas coupled components define the coupling of output to input ports of components. Every atomic component has a defined state at any time. State transition functions prescribe the change of this state if events occur. For internal events the internal transition function and for external events the external transition function define the new state. An output function returns the output events and a time advance function returns the remaining time in state.

In 1996 Parallel DEVS was introduced, which allows the parallel execution of DEVS models [2]. Input events are handled as a set of events and a confluent transition function defines the new state in case of concurrent internal and external events. For the simulation of such Parallel DEVS models specific simulation protocols are required. The Parallel DEVS simulation protocol is based on a direct mapping approach and thus the processing of simultaneous internal events. This simulation protocol has been used for our work and is defined by the following steps: 1. Initialization, 2. Determination of the next event time, 3. Output of events, and 4. Execution of state transitions. Even though we focused on this protocol others could be implemented.

1.2 The OSGi Service Platform

The OSGi standard defines a dynamic module system for Java, the OSGi service platform. The OSGi Alliance (formerly known as the Open Services Gateway initiative) is an industrial consortium (Oracle, IBM, Siemens, ProSyst and others) founded in 1999, which is focused on the maintenance of this standard [10]. Several organizations have implemented the standard. Applications range from industrial automation over mobile applications to enterprise systems. Apache Felix, ProSyst mBS, and Eclipse Equinox (core of the Eclipse IDE) are well known implementations of OSGi. The OSGi framework is the core of the OSGi service platform. It provides a standard environment for run-time components, called bundles.

Bundles are JAR packages with additional manifest headers. Applications are developed from these reusable and loose coupled components. The framework architecture can be divided into three layers (Figure 1). The module layer defines class loading behaviour. In Java it is common to have one classpath, OSGi extends this model with modularization. Thus every bundle has its own classpath and holds private classes, that can be exported to other bundles.

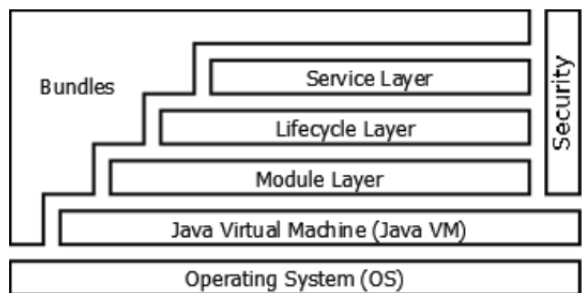

Figure 1. OSGi service platform.

The life-cycle layer adds run-time dynamics, that are normally not part of an application. It provides capabilities to install, start, stop, update, and uninstall bundles in an OSGi framework. This allows fine-grained maintenance on the level of bundles.

On the service layer services and the service registry are introduced. The basic model is a 'publish/find/bind/execute' pattern as in a service-oriented architecture (SOA). But it does not rely on web services, in fact in OSGi it operates within an application. Hence, POJOs ('Plain Old Java Objects') can be registered with the OSGi service registry. These services can be found and executed by other bundles.

In the OSGi service compendium [11] and corresponding specifications, such as the OSGi enterprise specification [12], system services for numerous domains of application development are specified. For our work the event admin service and remote services have been used. The event admin service defines a simple 'publish/subscribe' pattern.

Thus bundles can register (subscribe) event handler services for a specific topic with the service registry. If an event is posted (published) via an event admin service implementation, it will be delegated to all corresponding event handlers. Remote services provide the ability to register services not only for internal use in the framework, they can be made remotely accessible, so that bundles of another framework or even other applications can make use of them.

Furthermore external services, such as web services, can be registered with the service registry. The type of service distribution and discovery depends upon installed distribution and discovery providers (Figure 2). Several implementations for service discovery exist, e.g. via IP broadcast (Zeroconf or SLP) or distributed configuration servers with Apache ZooKeeper. Distribution providers rely on protocols such as RMI, Web Services (SOAP/REST), or R-OSGi [13].

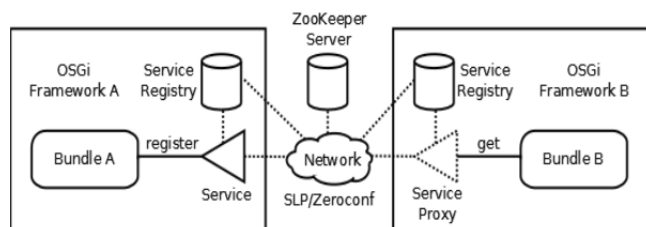

Figure 2. OSGi remote services.

1.3 Related Work

Even though OSGi has not been used to simulate DEVS models, some simulation environments use the Eclipse IDE and Eclipse plug-ins for component-based simulation. In [3] the implementation of an object-oriented generic simulation environment based on Eclipse is introduced. The main benefits identified are the separation of model and experiments and the extensibility via Eclipse plug-ins. However, this simulation environment is not capable of simulating DEVS models. Another flexible, extendible, and reusable simulation framework is James II [7]. It is based on an OSGi-like architecture that uses plug-ins for the integration of different simulators, including DEVS. But this approach does not use OSGi as plug-in environment.

The CD++Builder introduced in [1] is an Eclipse plug-in and thus uses the OSGi bundle concepts, but it is only used in terms of DEVS modelling and does also not use OSGi plug-ins for the implementation and simulation of DEVS models. Several protocols and distributed middleware concepts have been applied for distributed simulation of DEVS models in Java. The most appropriate one is DEVS/SOA [9], which uses a SOA and thus classic SOAP web services for distributed interoperability among simulators. It enables run-time composability and has been approved of simulating DEVS models in parallel. Even though the architecture of DEVS/SOA is service-oriented, it is still rather different from the service-oriented interoperability and distribution concept provided by the OSGi service layer and OSGi remote services.

The approach of a shared abstract model (SAM) introduced in [15] targets the integration of heterogeneous models and uses proxies as abstraction of model interfaces. SAMs can be implemented using sound distribution middleware and enable flexible and non-tedious integration of new component models. This is indeed close to our intent of the abstraction of the interoperability infrastructure. Next to distributed interoperability our goal is to enable dynamic reconfiguration within the simulation framework. With a variable structure approach introduced in [8] dynamic reconfiguration can be achieved during run-time. Components can be added, removed, updated or migrated and connections between components can be added or removed dynamically. However, the run-time dynamics and distribution concepts provided by the OSGi lifecycle and service layer have not been fully utilised yet.

2 The DEVS/OSGi Simulation Framework

The DEVS/OSGi simulation framework introduced in this chapter will enable all benefits of object-oriented application frameworks: Modularity, reusability, extensibility, and inversion of control [5]. Furthermore a service-oriented architecture concept is used for interoperability and extended modularity, e.g. loose coupling and run-time dynamics.

2.1 Approach

Obviously DEVS and OSGi rely on the same basic concept, a decomposed system approach. In DEVS a system is being modelled from decomposed components, while with OSGi applications are build out of components. Furthermore OSGi is based upon service-oriented interoperability concepts, proven to be appropriate for distributed simulations of DEVS models. Both standards have not been integrated in a well-founded way yet. Thus our approach is to bring together both standards and enable dynamic distributed simulation. In fact two aspects need to be considered, first the mapping of the DEVS formalism onto the OSGi service platform and second the concepts of interoperability and distribution for the Parallel DEVS simulation protocol.

DEVS components (implemented as Java classes) are wrapped into bundles that register a service with the OSGi service registry. Notice, that in case of this 1:1 mapping only one DEVS component is wrapped into a single bundle. Although this is not the best for every application, it enables the full power of OSGi life-cycle layer dynamics, e.g. installation/uninstallation and update of DEVS components. Drawbacks and potential improvements of this mapping will be discussed later.

The interoperability can be described as an abstract integrated service-oriented architecture, that is basically provided by the OSGi service platform. The service-oriented design is similar to the concepts of DEVS/SOA but protocol independent (abstract) and more fine-grained (integrated). The interoperability is abstract as it depends upon the installed discovery and distribution providers. The term integrated reflects the service concept that is being used internally in a simulation node and also externally via OSGi remote services. Both issues will be described in the following two chapters in detail.

2.2 Architecture

The main bundle of the DEVS/OSGi simulation framework (Figure 3) is the DEVS/OSGi core bundle. It consists of all interfaces and abstract classes required for the implementation of DEVS/OSGi components, simulators, and nodes.

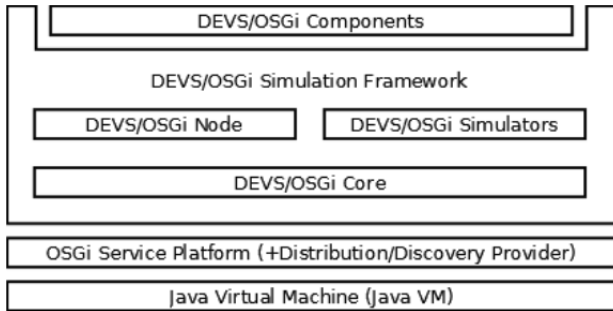

Figure 3. DEVS/OSGi simulation framework.

DEVS/OSGi components are simple DEVS component classes that implement a DEVS/OSGi atomic or coupled component interface. These interfaces define the methods of the DEVS formalism and thus should be compatible with every DEVS component implemented for other simulation environments. The component classes are then wrapped into bundles and register a component service on startup (Figure 4a). DEVS/OSGi simulators implement the steps of the Parallel DEVS simulation protocol. Each simulator installed in a simulation node is responsible for a specific type of component. It instantiates a simulator object for each corresponding component and registers this as remote simulator service with the OSGi service registry (Figure 4b).

DEVS/OSGi nodes are not required for the execution of a simulation, however we have defined a node service that represents our simulation nodes in the service environments.

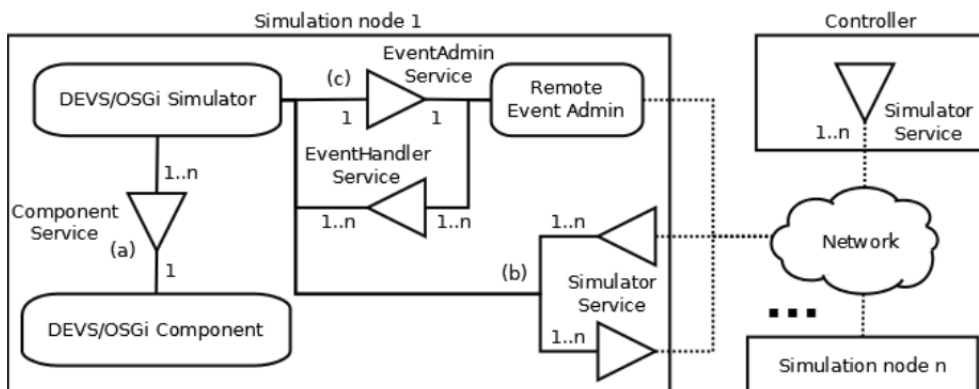

Figure 4. DEVS/OSGi simulation framework services and distribution.

With this it is possible to install, uninstall and update DEVS/OSGi component bundles into remote simulation nodes. Furthermore information about installed components, states and simulation progress are provided that can be used by the controller (GUI).

The interoperability of a simulation is related to simulation control and event delegation. The simulation is controlled by a root simulator that is typically installed in a separate controller node. This root simulator is aware of the simulator service belonging to the root component (this needs to be set/selected). It executes the steps of the simulation protocol via asynchronous calls and dictates the simulation time advance, e.g. real time or as fast as possible. The same is done by every coupled simulator, they are responsible for the execution of the steps on their child simulators. Invocation of all (root/child) simulators is realised via OSGi service layer and OSGi remote services. Thus the simulation control is executed transparently without knowing if the simulator is installed in the local or in a remote simulation node.

Event delegation uses the OSGi event admin and thus a 'publish/subscribe' pattern (Figure 4c). As mentioned before, event handlers are registered for each port. If events are posted to the OSGi event admin, it is responsible for the delegation to all appropriate event handlers of other simulators. As regular OSGi event admin implementations are only used for framework internal event delegation, we had to implement a remote event admin.

2.3 Implementation

The implementation is similar to others for DEVS, such as DEVS/SOA. However with the implementation of the DEVS/OSGi simulation framework some recent concepts of the Java programming language, such as generics, annotations, and exception handling were integrated. Especially the use of generics for the separation of state and component implementation brings significant improvements for the development of DEVS/OSGi simulators.

The state is implemented as separate class and generic type of the corresponding component. Thus simulators manage the state of its components using Java generics and can store state data via object serialization. The abstract simulator classes implement a service tracker concept to recognize component services and (child) simulator services installed within the simulation environment dynamically. The event delegation via OSGi event admin has also been implemented on this abstract level. For this we needed to implement a remote event admin implementation, which uses service proxies for remote event handler services and thus uses OSGi remote services for event delegation.

We have implemented two default simulators based on the Parallel DEVS simulation protocol, one is appropriate for atomic, the other for coupled DEVS/OSGi components. The atomic simulator manages the state and functions of components, as mentioned in Chapter 1.1. The coupled simulator manages all child simulators and executes the simulation steps. All steps are executed as asynchronous/non-blocking calls. Furthermore we implemented a default node implementation and a controller (with GUI) for the decentralized installation of DEVS/OSGi components (Figure 5). We built releases of both, node and controller (including the core and simulators), so that they can be used standalone without the Eclipse IDE.

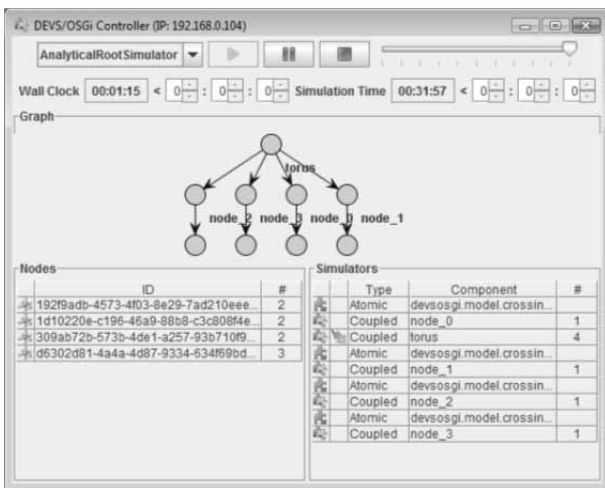

Figure 5. DEVS/OSGi Controller GUI.

3 Experiments

In order to validate the framework architecture and implementation we have conducted some experiments. The main objective was to test functionality and performance. For all experiments the DEVS/OSGi simula-

tion framework was installed in an Eclipse Equinox (3.6.1) OSGi framework. We used the Eclipse Communication Framework (ECF) in version 3.4 as OSGi remote service implementation. The best performance could be achieved with the ECF generic distribution provider based on sockets and ZooDiscovery based on Apache ZooKeeper as discovery provider.

3.1 Traffic Simulation Model

We have implemented a single road crossing as an atomic DEVS component. Cars pass the crossings and are directed to other crossings via output and input events. The traffic lights consist of four states (green, yellow, red+yellow, and red), thus we possibly gain multiple simultaneous events per simulation step. This component was then replicated (wrapped) with different traffic light configurations and cars queuing in front of them. The crossings were connected using coupled DEVS components that form a torus model (Figure 6).

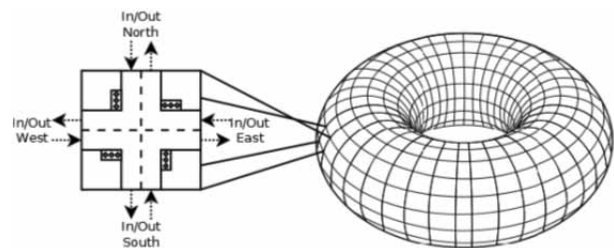

Figure 6. Traffic simulation model.

3.2 Results

We have installed models with 4^1 to 4^4 crossings on different distributed simulation configurations (1, 4, 8, and 16 nodes) and run several simulation runs. Every simulation run was set to 24 hours simulation time. The results in Figure 7 show, that we can achieve a speed-up ($T1/Tn$, Tn = simulation time on n nodes) greater than 1.0 for torus models with 64 and 256 crossings. The torus model with 256 crossings can be executed on four, eight, and sixteen simulation nodes faster than on one. An average speed-up of 1.84 was obtained.

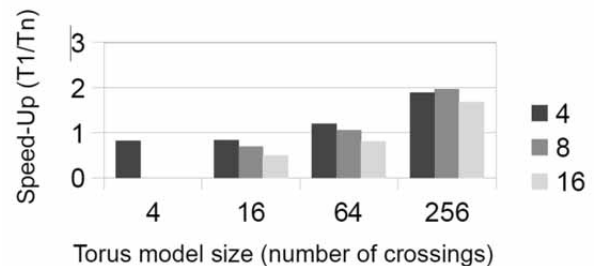

Figure 7. Speed-up on 4, 8, and 16 simulation nodes.

3.3 Discussion

The performance tests with the traffic simulation models approved the simulation framework executing steps in parallel. But due to memory utilisation we could install only 256 crossing bundles per simulation node and the installation time was significantly high. For performance tests replication of crossings as bundles is appropriate, but in fact it is not that reasonable installing bundles consisting of the same class into one simulation node. Thus support for multiple occurrence as described in [4] should be considered. In other applications it could be appropriate wrapping more than one DEVS component into a bundle. The challenge is to address these issues without losing the power of the runtime dynamics provided by the OSGi service platform.

4 Conclusions

The OSGi run-time dynamics are highly valuable for plug-and-play capabilities and dynamic reconfiguration in DS, especially for the integration of simulators, components, and distribution/discovery providers, dynamic assembly of distributed models and dynamic distribution of components. Furthermore OSGi provides a standardised and protocol independent interoperability infrastructure. The DEVS/OSGi simulation framework is fully compatible to Eclipse plug-ins and has been tested using the Eclipse Equinox OSGi framework. Nevertheless some research needs to be done on the implementation of multiple occurrence and the integration of heterogeneous simulators. Further integration into the Eclipse IDE in means of extensions and views would be useful. Additionally OSGi has a lot more capabilities that could be integrated, such as versioning and configuration management.

We focussed our experiments on an analytical simulation context. In DVE the system accuracy is lower and possibly its components more heterogeneous, thus the DEVS/OSGi simulation framework may be even more appropriate.

References

- [1] C. Chidisiuc, G. A. Wainer. *CD++Builder: An Eclipse-based IDE for DEVS Modeling*. Proceedings of the 2007 Spring Simulation Multiconference (2007).
- [2] A. Chung-Hen Chow, B. P. Zeigler. *Parallel DEVS: A Parallel, Hierarchical, Modular Modeling Formalism and its Distributed Simulator*. Transactions of SCS, Volume 13, Issue 2 (1996), 55-68.
- [3] R. Czogalla, N. Knaak, B. Page. *Simulating the Eclipse Way: A Generic Experimentation Environment Based on the Eclipse Platform*. Proceedings of the 20th European Conference on Modelling and Simulation (2006).
- [4] O. Dalle, B. P. Zeigler, G. A. Wainer. *Extending DEVS to Support Multiple Occurrence in Component-based Simulation*. Proceedings of the 2008 Winter Simulation Conference (2008).
- [5] M. Fayad, D. C. Schmidt. *Object-oriented Application Frameworks*. Communications of the ACM Volume 40, Issue 10 (1997), 32-38.
- [6] J. Himmelspach, A. M. Uhrmacher. *Plug'n Simulate*. Proceedings of the 40th Annual Simulation Symposium (2007), 26-28.
- [7] X. Hu, B. P. Zeigler, S. Mittal. *Variable Structure in DEVS Component-Based Modeling and Simulation*. SIMULATION Volume 81, Issue 2 (2005), 91-102.
- [8] S. Mittal, J. L. Risco-Martín, B. P. Zeigler. *DEVS/SOA: A Cross-Platform Framework for Net-centric Modeling and Simulation in DEVS Unified Process*. SIMULATION Volume 85, Issue 7 (2009), 419-450.
- [9] OSGi Alliance: OSGi Service Platform – Release 4.2. aQute Publishing, 2009.
- [10] OSGi Alliance. OSGi Service Platform, Service Compendium – Release 4.2. aQute Publishing, 2009.
- [11] OSGi Alliance. OSGi Service Platform, Enterprise Specification – Release 4.2. aQute Publishing, 2009.
- [12] J. S. Rellermeyer, G. Alonso, T. Roscoe. *R-OSGi: Distributed Applications through Software Modularization*. Proceedings of the ACM/IFIP/USENIX 8th International Middleware Conference (2007), 1-20.
- [13] S. Strassburger, T. Schulze, R. Fujimoto. *Future Trends in Distributed Simulation and Distributed Virtual Environments: Results of a PeerStudy*. Proceedings of the 40th Conference on Winter Simulation (2008), 777-785.
- [14] T. Wutzler, H. S. Sarjoughian. *Interoperability among Parallel DEVS Simulators and Models Implemented in Multiple Programming Languages*. SIMULATION Volume 83, Issue 6 (2007), 473-490.
- [15] B. P. Zeigler, H. Praehofer, Tag Gon Kim. *Theory of Modeling and Simulation*. San Diego: Academic Press, 2000.

Accepted ASIM SST Winterthur, September 2011

Submitted: September 2011

Accepted October 20, 2011

Kinetic Model for Dose Equivalent - an Efficient Way to Predict Systems Response of Irradiated Cells

Stephan Scheidegger^{1*}, Rudolf Marcel Fuchslin^{1,2}

¹ Centre of Applied Mathematics and Physics, Zurich University of Applied Sciences Technikumstrasse 9, 8401 Winterthur; *scst@zhaw.ch

² European Centre for Living Technology, S. Marco 2940, 30124 Venice, Italy

Abstract. The response of tumours onto ionizing radiation cannot be fully understood by commonly used radiobiological models. The reason may lie in the complex structure of the cellular systems which show a high degree of compartmentalisation and which is characterised by a network of interacting processes at different time scales. To access the dynamic response of cells onto radiation, compartmental models based on a biological dose equivalent can be used. Two different models (Γ -LQ- and Γ -IRmodel) are used to fit experimental data of the clonogenic survival of irradiated cells at very high dose rates. The models reveal the correct dose rate dependence over a wide range of the parameter space when adapting the kinetic constants to the dose rate. This adaption could be an indication for the multi-scale structure of the system.

Introduction

Modern computers and modelling tools allow an efficient implementation and subsequent numerical treatment of biomedical models. Such simulations may be used for the exploration of the dynamic response of tumours onto anticancer treatment. This could lead to a quantitative basis for optimizing therapies, especially for novel or combined modalities such as radiotherapy and hyperthermia. However, such an approach requires to find a mathematical model or formulation describing the biological system in an appropriate way.

Biologically, the insufficiency of currently used models may be largely due to the complexity of the biological system: A whole variety of different intracellular mechanisms contribute to cellular repair and this at different time and dose scales. Not all of them are quantitatively (or even qualitatively) fully described. In addition, some solid tumours exhibit enhanced radiosensitivity at very low doses [1,2].

Above a certain dose threshold, however, increased cellular repair can be observed for these cell lines which, on a first glance counter-intuitive, lowers radio sensitivity. This indicates a dose- and possibly dose rate dependent induction of repair mechanisms. The shortcomings of in vitro based models may also be caused by the inherent neglect of intercellular processes related to tissue dynamics, such as competition with host tissue, vascularisation and oxygenation, immune reactions and related inflammatory processes or bystander effect [2].

Kinetic models at the level of cellular repair are described by many authors (e.g. Tobias [3] Curtis [4] and Carlone et al. [5] and Dale [6]). However, the extension to tissue interaction is difficult, since these models are based on the number of DNA lesions.

To calculate the number of surviving cells, Poisson statistics is used. Since repopulation, competition or oxygen consumption depends on the population size, it would be favourable to use a corresponding formalism directly based on the numbers of tumour cells for models dedicated to the in vivo tumour dynamics. In addition, all these models do not reflect the fact that the cellular response cannot be explained by DNA lesions kinetics alone.

This article is addressing the following question: Is it possible to map the complex dynamic response of irradiated tumour cells onto simple kinetic models using a biological dose equivalent. Two kinetic approaches for modelling the dynamic tumour response onto radiation are presented. The models are based on a biological dose equivalent, which allows a flexible implementation of different aspects of dose rate dependent repair modifications and the interaction of intra- and extracellular processes. The models are compared to experimental data. The results indicate a high potential of kinetic models for investigating clinical aspects of anticancer therapy.

1 Materials and Methods

The models combine, necessarily in a heavily simplified manner, temporal changes of the tumour population (number of tumour cells $N = N(t)$), which may be composed of different subpopulations i (number of tumour cells $N_i = N_i(t)$) and a kinetic model for a biological dose equivalent Γ . The unit of Γ is that of the absorbed dose D (energy per mass, J/kg = Gy). Initially, the concept of a biological dose equivalent was proposed by Oliver [7]. Here, the dose equivalent Γ is assumed to be proportional to the average number of unrepaired sublethal entities per a single cell produced by radiation.

During irradiation, the energy deposition in tissue is much faster than the repair processes or the development of cellular damage. In this sense, $\Gamma = \Gamma(t)$ can be interpreted as transient dose, increasing with the dose rate

$$R = \dot{D} = dD/dt$$

and decaying with the repair of the sublethal lesions.

In principle, the kinetic model for Γ summarizes the biophysical and biochemical processes of energy deposition of radiation (ionisation, excitation), production of radicals and peroxides (in case of X-rays and / or electrons), reaction with biomolecules (DNA), lesions kinetics and repair of sublethal lesions. The equations describing the system (tumour cell population and kinetic dose equivalent model) are the following:

$$\begin{aligned} \frac{dN_i}{dt} &= f(N_i, N_k, \dots, \Gamma) \\ \frac{dN_k}{dt} &= g(N_i, N_k, \dots, \Gamma) \\ \frac{d\Gamma}{dt} &= R - h(\Gamma) \end{aligned} \quad (1)$$

Here, $h(\Gamma)$ is a function of Γ representing the kinetics of repair of sublethal lesions, given at dose rate R .

In the case of first order repair kinetics (as proposed by Oliver [7]), the repair rate is linear-proportional to the number of sublethal entities. Since an increasing number of experiments indicate a change of the half-time of repair, biexponential or binary repair (including two components of mono-exponential repair) is taken into account by several authors [8].

The observation of a fast repair shortly after irradiation and a following slower repair rate compared to exponential repair may also be explained by a second order process [6]. This implies, that the Γ - dependent function $h(\Gamma)$ in Eq.(1) is given by $h(\Gamma) = \gamma \cdot \Gamma_1^{-2}$. For the following models, second order kinetic is used.

The quantity Γ is related to the dose D and the total dose D_{tot} (= cumulative applied dose):

$$\lim_{t \rightarrow \infty} \left[\int_{-\infty}^t h(\Gamma(\tau)) d\tau \right] = \lim_{t \rightarrow \infty} [D(t)] = D_{tot} \quad (2)$$

1.1 The Γ -LQ-Model Formulation

In the Γ -LQ- model formulation [9], only one tumour population (with the number of tumour cells $N = N(t)$) is used. Cell killing is described by two radiosensitivity coefficients α and β . The system (Eq.1) becomes:

$$\begin{aligned} \frac{dN}{dt} &= -(\alpha + 2\beta\Gamma) \cdot R \cdot N \\ \frac{d\Gamma}{dt} &= R - \gamma\Gamma^2 \end{aligned} \quad (3)$$

At the beginning of an irradiation, Γ is equal to the initial value $\Gamma(0)$. Integration of Eq. (3) using the constant value $\Gamma(0)$ leads to the surviving fraction:

$$S = e^{-(\alpha + 2\beta\Gamma_1(0)) \cdot D}$$

The initial slope in the logarithmic diagram ($\log S = \ln S / \ln(10)$) for $\Gamma(0) = 0$ Gy for both first order and second order kinetics is $-\alpha / \ln(10) = -\alpha'$. This is in agreement with the commonly used linear-quadratic (LQ) model.

In the case of $\gamma = 0$, the quantity Γ accumulates without outflow. Therefore Γ is equal to the accumulated dose: $\Gamma(t) = D(t)$. In this case, integration of Eq. (5) leads to the classical LQ formalism with

$$N(D) = N_0 \cdot e^{-(\alpha D + \beta D^2)}$$

For a single fraction with a constant dose rate R , $\Gamma(t)$ tends to an equilibrium (which will be reached for $t \rightarrow \infty$).

For second order, the equilibrium level is $\Gamma_{eq} = \sqrt{R/\gamma}$. For this equilibrium state, Eq. (3) can be solved by separation and integration, since Γ becomes constant:

$$\Gamma(t) \rightarrow \Gamma_{eq} : N(D) = N_0 \cdot e^{-(\alpha+2\beta\Gamma_{eq})D}$$

The logarithmic of surviving fraction $S = N / N_0$ is given by

$$\ln S = -(\alpha + 2\beta\Gamma_{eq}) \cdot D$$

The final slope in a logarithmic plot of the surviving fraction becomes constant:

$$\left[\frac{d \ln S}{dD} \right]_{\Gamma \rightarrow \Gamma_{eq}} = -(\alpha + 2\beta\Gamma_{eq}) \quad (4)$$

1.2 A Kinetic Model for Induced Repair:

The Γ -IR- Model

The model formulation (Γ - IR- model) is based on two differential equations describing the radiation induced reduction of normal tumour cells N_1 and the recovery of lethally damaged cells N_2 (with the dose rate R and a coefficient for radiosensitivity α):

$$\begin{aligned} \frac{dN_1}{dt} &= -\alpha RN_1 + \Theta(\Gamma, N_2) \\ \frac{dN_2}{dt} &= \alpha R \cdot (N_1 - N_2) - \Theta(\Gamma, N_2) \end{aligned} \quad (5)$$

The term $\Theta(\Gamma, N_2)$ describes an additional, dose dependent repair mechanism with a characteristic dose equivalent Γ_c :

$$\Theta(\Gamma, N_2) = \nu \cdot e^{-\kappa(\Gamma - \Gamma_c)^2} N_2 \quad (6)$$

This approach can be justified by an activation of the additional repair process, which occurs for each cell at a different threshold dose [10]. It is assumed, that these thresholds can be characterized by a probability distribution with the maximum value Γ_c . The parameters α and Γ_c can be determined directly from the logarithmic diagram ($\log S$) of the surviving fraction $S = N_1 / N_1(0)$, α by the initial slope:

$$\left[\frac{d \log S}{dD} \right]_{D \rightarrow 0} = -\alpha \quad (7)$$

The parameter Γ_c can be estimated from the local maximum (shoulder) of $\log S$, if low dose hypersensitivity appears. The parameters δ and κ can be used for fitting experimental data. The final slope of the $\log S$ - curve is determined by the equilibrium of the dose equivalent $\Gamma_{eq} = \sqrt{R/\gamma}$. For this equilibrium condition, the following system of first order ODL results with the matrix m_{ik} to

$$\begin{aligned} d/dt [N_i] &= m_{ik} N_k \\ m_{ik} &= \begin{pmatrix} -\alpha R & \delta e^{-\kappa(\Gamma_{eq} - \Gamma_c)^2} \\ \alpha R & -(\alpha R + \delta e^{-\kappa(\Gamma_{eq} - \Gamma_c)^2}) \end{pmatrix} \end{aligned} \quad (8)$$

The final slope of the $\log S$ - curve is constant and dose rate dependent since the eigenvalues of the system Eq. (5) are:

$$\begin{aligned} \lambda_{1,2} &= -\alpha R - \frac{\nu}{2} \cdot e^{-\kappa(\sqrt{R/\gamma} - \Gamma_c)^2} \\ &\pm \frac{1}{2} \sqrt{\left(4\alpha R \cdot \delta e^{-\kappa(\sqrt{R/\gamma} - \Gamma_c)^2} + \nu e^{-2\kappa(\sqrt{R/\gamma} - \Gamma_c)^2} \right)} \end{aligned} \quad (9)$$

2 Results

Both models can be implemented easily by using graphical model editors such as Berkeley Madonna or equivalent. The results of the simulation using Berkeley Madonna (Berkeley Madonna Inc.) were compared to experimental data. The comparison of the Γ - LQ- model with the in vitro data from Wells and Bedford [11] reveals a good fit to the logarithm of surviving fraction of irradiated C3H10T1/2 cells (Fig.1) over a wide range of the dose rate, if the kinetic constant γ is adapted to the dose rate:

$$\gamma = a/R^2 + bR + c \quad \text{with } a = 1100 \text{Gy}^3 / d^3,$$

$$b = 1.4 \cdot 10^{-2} \text{Gy}^2 \text{ and } c = 5 \text{Gy}^{-1} d^{-1}.$$

The term a/R^2 is only important at dose rates below 100 Gy/d (=0.07Gy/min). The term a/R^2 is only important at dose rates below 100 Gy/d (= 0.07 Gy/min).

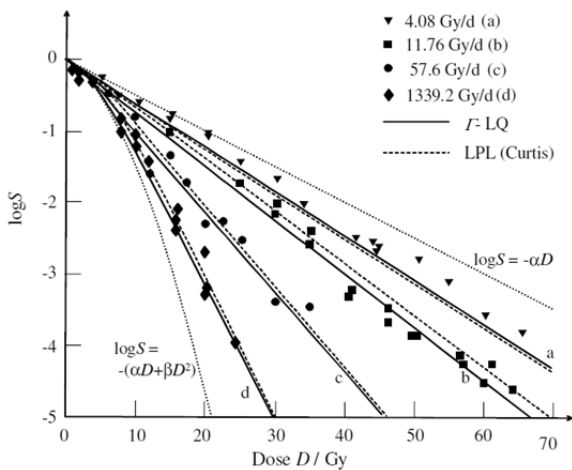

Figure 1. Comparison of the F -LQ formulation (second order kinetics, solid lines) with experimental data (C3H10T1/2 cells with $\alpha = 0.1366 \text{ Gy}^{-1}$ and $\beta = 0.02 \text{ Gy}^2$, irradiated at different dose rates) from Wells and Bedford [11] and the model of Curtis (dashed lines): The dotted lines are at the right side the limit at low dose rate ($\log S = -\alpha D$) and at the left side the common LQ-model.

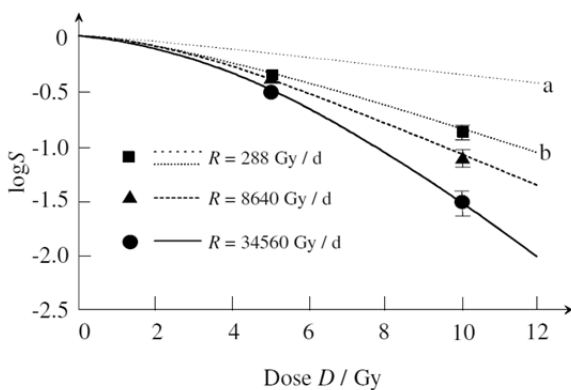

Figure 2. Surviving fraction of T98G- glioblastoma cells at different dose rates: For the high dose rate (8.64 kGy/d and 34.56 kGy/d), the F -LQ- model can fit the experimental data with $\alpha = 0.03 \text{ Gy}^{-1}$, $\beta = 0.04 \text{ Gy}^2$ and $\gamma = 600 \text{ d}^{-1}$; for the intermediate dose rate ($R = 288 \text{ Gy/d}$), a good fit can only be achieved by adapting the kinetic constant to $\gamma = 45 \text{ d}^{-1}$ (curve b, curve a with $\gamma = 600 \text{ d}^{-1}$).

For dose rates above 1500 Gy/d ($= 1.04 \text{ Gy/min}$), the curves are lying between the curve d in Figure 1 and the curve for the LQ- model. In this area, a good fit to the model of Curtis is also reached with $\gamma = bR + c$.

The F -LQ- model was used to fit data from irradiated glioblastoma cells at very high dose rate (Figure 2). The parameters were adjusted to the data set produced at the highest dose rate. Therefore, the model using a constant γ fits the data not very adequately at intermediate dose rate ($R = 288 \text{ Gy/d}$) but reveals a good fit for the very high dose rates ($R = 8640 \text{ Gy/d}$ and 34560 Gy/d) with a constant value for γ .

The kinetic model for induced repair (F -IR- model, Section 1.2) is able to reproduce the surviving fraction in the case of low dose hypersensitivity as observed e.g. for irradiated breast cancer cells (Figure 3). Also the distinct behaviour of clonogenic survival of apoptotic versus non-apoptotic cell death can be explained by the F -IRmodel. The F -IR-model seems to fit a broad spectrum of radiobiological observations.

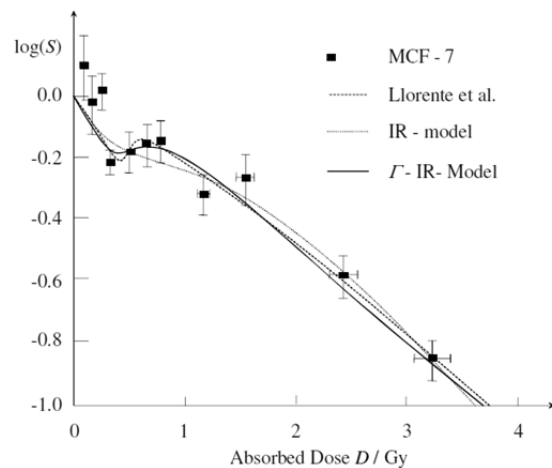

Figure 3. Comparison of the proposed F -IR- Model with the model of Guirado Llorente et al. [10], the IR-Model and experimental data (irradiated multi cellular spheroids of breast cancer MCF-7 cell line [10]); Parameters: $\alpha = 2.5 \text{ Gy}^{-1}$, $\Gamma_c = 0.6 \text{ Gy}$, $\kappa = 14 \text{ Gy}^{-2}$, $\gamma = 0.729 \text{ Gy}^{-1} \text{ min}^{-1}$ and $-\delta = 20.833 \text{ min}^{-1}$

To investigate the dose rate dependence, the F -IR- model was used to fit the in vitro data of the T98G glioblastoma cells shown in Figure 2 [12]. In Figure 4, a good fit of the experimental data can be achieved by adapting both, δ and γ to the dose rate.

The value of parameter δ is different for all three dose rates $\delta=10^3 d^{-1}$ for $R=288 \text{ Gy/d}$; $\delta=3.10 d^{-1}$, for $R=8.64 \text{ kGy/d}$ and $\delta=1.6 \cdot 10^5 d^{-1}$ for $R=34.56 \text{ kGy/d}$ whereas the kinetic constant γ has the same value $\gamma=540 \text{ Gy}^{-1} d^{-1}$ for $R=8.64 \text{ kGy/d}$ and $R=34.56 \text{ kGy/d}$. Only for $R=288 \text{ Gy/d}$, the value is set to $\gamma=23 \text{ Gy}^{-1} d^{-1}$.

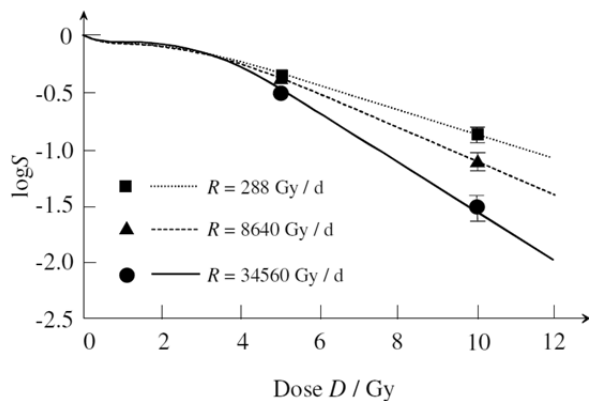

Figure 4. Comparison of the proposed F -IR-Model with experimental data (T98G glioblastoma [12]);

Parameters: $\alpha=0.5 \text{ Gy}^{-1}$, $\Gamma_c=1.2 \text{ Gy}$, $\kappa=0.45 \text{ Gy}^{-2}$, δ and γ are adapted to the dose rate.

3 Discussion and Conclusions

The use of a dose equivalent concept leads to a flexible structure of model formulation. Both models are able to fit the observed dose rate dependence of experimental data although more experimental data for fitting should be available (especially Figure 2 and 4). But in both models, the kinetic constant has to be adapted to the dose rate to achieve a good fit over the whole range of dose rate. Only for a dose rate above $8.64 \text{ kGy/d} = 6 \text{ Gy/min}$, the F -LQ- model reveals a good fit with three dose rate independent constants. The adaption of the constants to the dose rate in addition to the dose rate dependency given by the kinetic model for dose equivalent indicates that different mechanism at different time scales contribute to the repair and cell death processes. The use of a dose equivalent to describe cellular damages is a simplistic approximation of a very complex system, but it allows approaching the dynamic system behaviour by a kinetic model structure.

In addition to the intracellular processes, the communication between cells are important for the tumour (tissue) response (e.g., bystander effect [1,2]). Damaged cell do not only repair themselves, but somehow (possibly via cytokines) transmit the information about the fact that they are damaged to other cells, probably in their direct proximity. This 'cross-talk' on the tissue-level is the base for the appearance of emergent behaviour, as it is well known from many physical systems, e.g. near phase transitions.

This seems to be similar to thermodynamics, where a very diverse and complicated microscopic dynamics nevertheless leads to a macroscopic phenomenology which is well described in terms such as internal energy, temperature etc. However, comparing cellular dynamics with thermodynamics is only sensible on a higher level of abstraction. Cellular processes are generically not in equilibrium, whereas the concepts of thermodynamics only apply to equilibrium situations (in some cases stationary processes, which are globally not in equilibrium but allow sensibly speaking of local equilibria, are also well described by thermodynamic quantities). But there are structural similarities too: Thermodynamic systems are most often described by surprisingly few parameters and this is also a tacit (and experimentally justified) assumption of cellular modelling, probably caused by the fact that cellular as well as thermodynamic systems (e.g. phases) exhibit robust emergent behaviour.

Today, the observables of cellular systems are mostly chosen by criteria of experimental accessibility. In future, further effort should be spend to identify system parameters that represent the true dynamics of cellular systems as precise as possible. There may be a price to pay, because according measurement may be difficult. The benefit, however, reliable prediction of dynamics using comparably simple models, may bear a considerable potential for anti-cancer treatment.

References

- [1] P. Lambin, E. P. Malaise, M. C. Joiner. *Might intrinsic radioresistance of tumour cells be induced by radiation?* Int. J. Radiat. Oncol. Biol. 69(1996), 279-90.
- [2] C. Mothersill, C. B. Seymour, M. C. Joiner. *Relationship between radiation – induced low dose hypersensitivity and the bystander effect.* Radiat. Res. 157(2002), 526-32.
- [3] C.A. Tobias. *The repair-misrepair model in radiobiology: Comparison to other methods.* Radiat. Res. 104(1985), S77-95.

- [4] S. B. Curtis. *Lethal and potentially lethal lesions induced by radiation – A Unified Repair Model*. Radiat. Res. 106(1986), 252-70.
- [5] M.C. Carlone, D. Wilkins, G.P. Raaphorst. *The modified linear-quadratic model of Guerrero and Li can be derived from a mechanistic basis and exhibits linear-quadratic-linear behaviour*. Phys. Med. Biol. 50(2005), L9-13
- [6] R.G. Dale, J.F. Fowler, B. Jones. *A new incomplete-repair model based on a reciprocal-time pattern of sub-lethal damage repair*. Acta Oncol. 38 (1999), 919-29.
- [7] R.A. Oliver. *Comparison of the effects of acute and protracted gamma-radiation on the growth of seedlings of Vicia faba*. Int. J. Radiat. Biol. 8(1964), 475-88.
- [8] J.F. Fowler. *Repair between dose fractions: A simpler method of analyzing and reporting apparently biexponential repair*. Radiat. Res. 158(2002), 141-51.
- [9] S. Scheidegger, G. Lutters, S. Bodis. *A LQ-based kinetic model formulation for exploring dynamics of treatment response of tumours in patients*. Z. Med. Phys. (2011), in print: DOI: 10.1016/j.zemedi.2010.11.001
- [10] D. Guirado Llorente, M. Aranda, M. Ortiz Seidel, J. A. Mesa Pérez, J.M.D.L. Vega Fernandez, R. J. Martinez Luna, L. I. Zamora Ardoy, M. Villalobos Torres, A. M. Lallena. *Low dose hypersensitivity in multicellular tumour spheroids*. Radiother. Oncol. 96 (2010), Supl. 1, 607-8.
- [11] R. L. Wells, J. S. Bedford. *Dose rate effects in mammalian cells.IV. Repairable and nonrepairable damage in noncyclic C3H10T1/2 cells*. Radiation Research 94(1983), 105-34
- [12] K. Zaugg, I. Lohse, S. Lang, I. Hrbacek, N. Sanchez Macedo, J. Feng, U. M. Lütolf. *High dose radiation using a flattening filter free beam reduces cancer cell survival in vitro*. Proc. of 15th scientific annual meeting of SASRO (2011), 69

Accepted ASIM SST Winterthur, September 2011

Submitted: September 2011

Accepted November 10, 2011

Robustness against Interference in Wireless Sensor Networks

Sven Zacharias*, Thomas Newe

University of Limerick, sven.zacharias@ul.ie

Abstract. The response Networks (WSNs) are a novel technology combining sensory and distributed computing to sense large areas live and in detail. Since this emerging technology is at a point where it can be adopted for an increasing number of applications, reliability and interference of different networks become serious issues. This paper gives an overview of potential interference sources and their effects on the energy consumption for WSNs operating on the 2.4 GHz band of the IEEE 802.15.4 standard. It concludes with several practical solutions for developing reliable and robust WSN applications.

Introduction

Specifications. Wireless Sensor Networks (WSNs) are an emerging technology in the area of sensory and distributed computing. A WSN consists of sensor nodes, also called motes. Many sensor nodes, theoretically up to thousands or even millions, build a WSN. A single sensor node is a small and inexpensive device that is built of the following main parts: one or more sensors, a data processing unit, a wireless communication interface and an energy source.

The sensor nodes are designed to be spread without pre-configuration. They connect to a multi-hop ad hoc network and report their measurements or information, computed from the measurements, to a base station. This base station, also referred to as sink, is a gateway to another network, which is likely to be the Internet, or a computer that stores or reacts according to the received data.

1 Interference on the Physical Layer

The common communication interfaces for WSNs are based on the IEEE 802.15.4 standard [1]. It was originally developed for Low-Rate Wireless Personal Area Networks (LR-WPANs). WSNs normally use this standard behind its purpose of single-hop personal area communication and implement multi-hop communica-

tion over large areas. There is a high likelihood that the Physical Layer of most WSNs is at least partly managed by the communication module of the nodes [2].

There are three frequency basebands available, also known as the Industrial, Scientific and Medical (ISM) frequency bands. The detailed properties of these bands are named in Table 1.

Region	Frequency band (MHz)	Communication Channel	Data rate channel (kb/s)
World-wide	2,400 – 2,483.5	16	250
North America	902 – 908	10 (2003) / 30 (2006)	40 (2003) / 250 (2006)
Europe	868 – 868.8	1	20 (2003) / 100 (2006)

Table 1. The Industrial, Scientific and Medical (ISM) bands used in IEEE 802.15.4.

Many developers focus on the 2.4 GHz band, since it is available worldwide, it supports the highest data rate and many transmit modules are available. The trend of using this single frequency band leads to a crowded band due to the great amount of different applications using it. Additionally, other devices emit waves on this band: Bluetooth devices and Wireless Local Area Networks (W-LAN), wireless DECT phones, baby phones and other proprietary wireless devices. Microwave ovens and harmonics of monitors can also have the effect of interfering with the 2.4 GHz band. A technical report of the Jennic Cooperation [3] investigated the effects of different interference sources. This report reveals that W-LANs are the main source of interference, which is also noted in other publications [4].

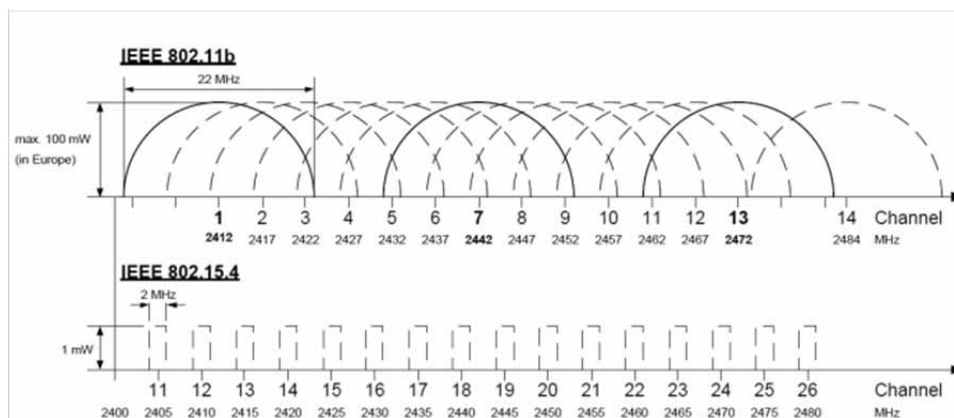

Figure 1. Channels of the 802.11b and 802.15.4 standard.

W-LANs based on the IEEE 802.11b standard have the same baseband and much more sending power than WSNs and can be seen as a major interference source, especially in urban areas. IEEE 802.11b as well as IEEE 802.15.4 separates their band into channels. 802.11b divides the band into 14 channels: each is 22 MHz wide and the Channel Centre Frequencies have a distance of 5 MHz between each other. Thus the channels overlap. For WSNs, there are 16 channels provided, each is 2 MHz wide and they are also distanced 5 MHz between each other. The counting of the WSN channels starts at 11, since there are more channels available on the lower frequency bands (see Table 1). Figure 1 gives an illustrative overview of the channels of both standards. W-LANs are often configured according to a rule of thumb: by using channels 1, 7 and 13 W-LANs do not interfere with each other. This would lead to the fact that the channels 15, 16, 21 and 22 are chosen for WSNs. In North America, the recommended channels for W-LANs are 1, 6 and 11, since channel 13 and 14 are not used.

Thus the theoretically best choices for WSNs are channels 15, 20, 25 or 26. Boano et al. [5] show the effects of an interference source on different MAC-protocols: NULLMAC, X-MAC [6], Low Power Probing [7], Low Power Listening [8] and CoReDac [9]. They also identify mechanisms to make MAC-protocols more robust against interference and to improve the X-MAC protocol that is implemented in ContikiOS in order to be more robust against interference on the Physical Layer.

2 Interference on the MAC-Layer

The Medium Access Control (MAC) Sublayer regulates the medium access and therefore is the most crucial operation for duty cycling of the nodes. Different nodes have to be awake at the same time to communicate. There are plenty of MAC-protocols for WSNs published, of which good overviews can

be found in the literature [10, 11]. As shown in the previous section, the frequency band of the Physical Layer is crowded and the number of channels is limited. Hence, having two WSNs using a single channel is a risk that has to be taken seriously.

The effects of two WSNs on the same channel that are operating locally close to each other are different to the effects of interference on the Physical Layer, since there is not a pure jamming of the medium, but a competition for it. There are two possible scenarios of WSNs operating in range of each other on the same channel:

- Two or more WSNs using the same MAC-protocol: The networks behave equally on the MAC-Layer. The effects on the applications are not enormous, since most MAC-Layers are designed to provide scalability.
- Two or more WSNs with different MAC-protocols. This scenario was not taken into account when most WSN MAC-protocols were designed. A common assumption is that fairness needs not to be considered, since WSNs are typical signal applications with all nodes working together [10, 11]. This scenario is investigated in the following.

2.1 MAC-Layer Protocols

In the following, two MAC-protocols are studied in further detail and, like most protocols, they have been designed for stand-alone usage, thus competition was no design concern.

X-MAC is a short preamble MAC-protocol. It uses an enhanced version of Low Power Listening (LPL) to save energy. The nodes turn off their radios for most of the time. If a node is about to send, it turns on its radio and sends short preambles (strokes) until it receives an acknowledgement.

If it receives an acknowledgement, the message is send. Non-sending nodes wake up after a sleep time for a short listening period to monitor the channel for strobes. Due to this behaviour, the idle listening time is reduced [6].

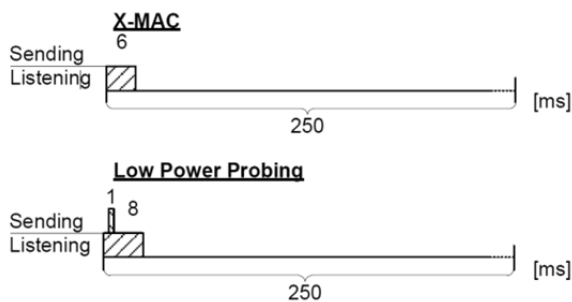

Figure 2. Idle Listening timing of X-MAC and Low Power Probing. (Do not scale from this drawing).

Low-Power Probing (LPP) is roughly the inverse approach to X-MAC. Instead of the sender announcing its will to send a message, the receiver is announcing its possibility to receive messages. When using LPP, all nodes are duty cycled and wake up for just a short time.

If a node is awake, it sends small packets (probes) to signal being awake and then it listens for a short time. A sending node turns its radio on and listens for the probe of the node that it wants to send to. When receiving it, the message is send [7]. The ideal idle listening cycle of X-MAC and LPP is shown in Figure 2. The cycles defined by the default parameters of the ContikiOS implementation generate a roughly comparable usage of the medium as the following figure reveals.

3 Energy Estimation

Since sensor nodes are likely to be battery powered, energy consumption is the key factor for the lifetime of a WSN. The estimation of the lifetime of a WSN can be complex, hence the network structure changes every time a node fails. The reliable estimation of the energy consumption of a single node is the base for further estimations. Today simulators offer a good estimation for energy consumption of single nodes in a friendly environment. In the following, COOJA, the simulator included in ContikiOS, is used. The TelosB sensor node [12] is the used hardware device. ContikiOS supports module on-time counters, thus the energy consumption can be estimated by multiplying the on-times of different modules by typical currents of the different modules. The used formula including the current factors is given in Equation 1.

The factors are taken from the shell power application included in ContikiOS and are discussed by Dunkels et al. in the publication of the software-based on-line energy estimation [13]. Similar factors can be found in other publications [12, 14]. In Table 2, measured values are compared with estimated values of a COOJA simulation. The used program was a simple non-interfered direct communication between a sender and a base station. The messages were sent randomly delayed in an interval of less than 5 seconds, and the energy was measured at the sender with the help of an Agilent 66321D Mobile Communications DC Source for a duration of 60 seconds. A section of the measurement is plotted in Figure 2 in full detail. NULLMAC is a protocol without any duty cycling, thus all modules are turned on all the time. The peaks of X-MAC and LPP show the radio being turned on for receiving or sending.

	NULLMAC	X-MAC	LPP
Estimated current (mA)	20.52	1.21	1.47
Measured current (mA)	18.89	0.95	1.07

Table 2. Measured and estimated currents of a TelosB sensor node. The measurement value is the mean value of a 60 sec. measurement. The estimation is based on the on-time counter simulated by COOJA for about 40 min.

$$\text{Estimated electric current [mA]} = \frac{\text{listen} \times 20 [\text{mA}] + \text{transmit} \times 17.7 [\text{mA}] + \text{cpu} \times 1.8 [\text{mA}] + \text{lpm} \times 0.545 [\text{mA}]}{\text{cpu} + \text{lpm}}$$

Equation 1. Energy consumption estimated by on-times of different modules with typical currents of the different modules.

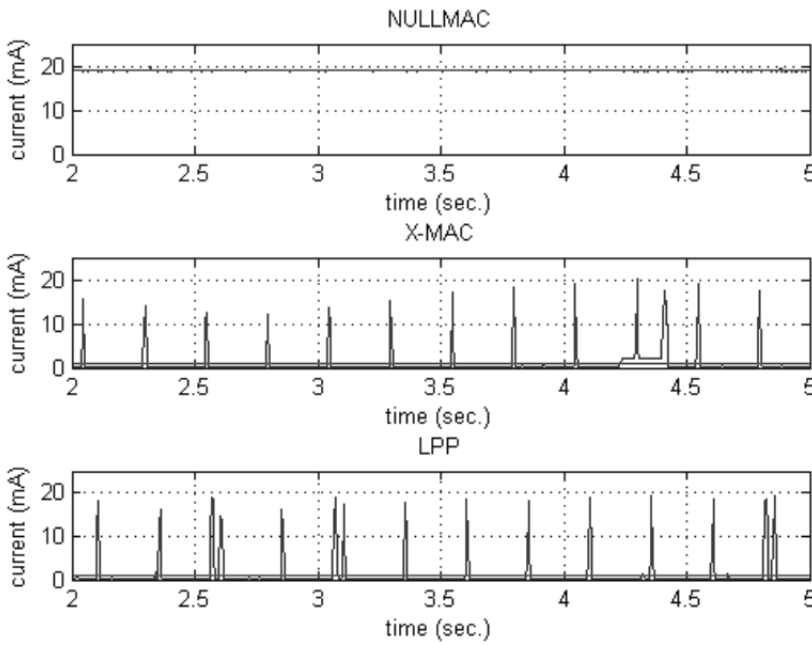

Figure 2. Measured current drawn by different MAC-Layer protocols on a TelosB node shown as a 3 sec. long section. (mean value line calculated of full 60 sec. easurement).

The estimation may seem to be imprecise, but since the measurement has just been taken for 60 seconds in the running program and the estimation used default factors, which may vary from node to node due to non-conformity of the electronic components. Although randomly send intervals are used, the results can be still seen as good indicators for the lifetime of a node.

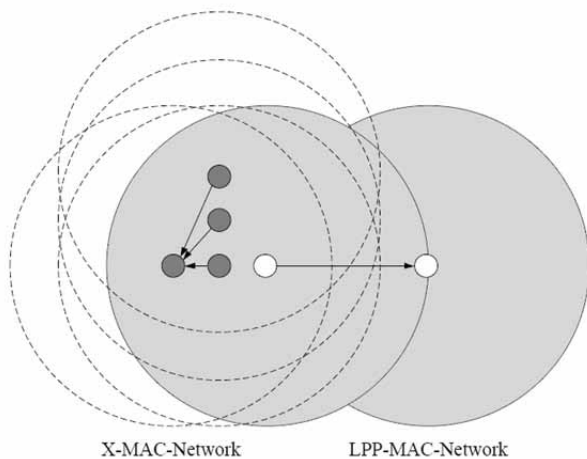

Figure 3. Simulation setup: nodes and their communication range.

3.1 Simulation Setup

A real-world experiment for MAC-protocol interference is hard to set-up, since the timing of the nodes is very important for stimulating certain patterns of behaviour and for causing a competitive situation. Therefore this paper relies on simulation.

The experiment was simulated for five different numbers of sensor nodes. Each of these different network sizes was simulated with and without interference, thus in total 10 simulations were completed. The main network operates with X-MAC while interference network uses LPP.

A single LPP node was in the range of all X-MAC nodes. In Figure 3 the network organisation is illustrated.

The main network runs an application sending a message every 5 seconds, concluding in 100 messages in total. The message consists of a timestamp and a counter. The interfering WSN sends a message every second.

3.2 Simulation Results

The simulation reveals that by an enforced bad timing, the rate of successfully delivered packets takes a nosedive. The duty cycle intervals are synchronous and X-MAC is not able to overcome this interference deadlock. The number of received packets is shown in Table 3. The table also shows logged errors of the MAC-Layer. Analysing only this logged data can help to estimate the delivery rate at the sending node, but is not accurate enough to guarantee delivery. For example, acknowledgements with packet sequence numbers and checksums are mechanisms to ensure a reliable delivery. But these mechanisms produce additional traffic and consume more energy.

Since no mechanism was implemented to ensure delivery, the total energy consumption of the WSN was not seriously affected. A cancelled send attempt is not consuming much energy, because X-MAC is announcing its sending with short strobes.

But by relating the estimated used energy to the successfully send packets, the impact of the interference is significant: The non-interfered WSN needs about 0.03 mA for a successfully sent packet and the worst effected interfered network (two X-MAC sender network) consumes about 0.11 mA per packet.

Number of sending nodes	Received packets at the base station	Errors logged at the sender
1	99/100	0
2	56/200	10 sending drops
3	159/300	144 cyclic redundancy check (crc)
4	400/400	0
5	500/500	0

Table 3 Received packets at the base station and logged errors at the sending nodes.

4 Conclusion

It was shown that the channels for WSNs are crowded and that there is the increasing chance of two or more WSNs operating locally close to each other on the same 802.15.4 channel. In this case, as shown in the simulation, competition for the medium access can occur. The following methods can be used in order to improve the robustness against interference either on the Physical Layer (channel jamming) or in form of competition of two different MAC-protocols. The list does not include mechanisms to guarantee delivery.

- Pre-deployment channel investigation: The creator of a WSN should be aware of potential interference sources and could make some measurements to find potential interference sources. The possibilities might be limited for large or ad-hoc networks, but for indoor deployment at least a W-LAN channel check should be done.

- Random sending intervals on Application Layer: A simple way to improve the robustness, without modifying any of the lower layers, is to send data in random intervals.
- Packet buffer and train: Boano et al. [5] recommend holding packets in a buffer so that cancelled send attempts can be redone. The buffer can also be emptied at once with a so-called train when first sending was successful.
- Low power sending: Messages should be sent with just the power needed to reach the next hop. This helps to save energy, since multi-hopping consumes less energy than directly transmitting to a more distant node and is less interfering.
- Channel Hopping/Spread Spectrum: By changing the channel permanently, the effect of a single interfered channel is minimised. Eavesdropping is also getting more difficult. On the other hand, this adds complexity and management overhead. The nodes have to be synchronised, which is a complex task in multi-hop or ad-hoc networks. Bluetooth uses Channel Hopping.

Acknowledgement

The authors wish to thank the following for their financial support: the Embark Initiative and Intel, who fund this research through the Irish Research Council for Science, Engineering and Technology (IRCSET) postgraduate Research Scholarship Scheme.

References

- [1] IEEE. *IEEE Standard 802.15.4™-2003*, 2003
- [2] Chipcon. *CC2420 2.4 GHz IEEE 802.15.4 / ZigBee-ready RF Transceiver*. June 2004 Datasheet
- [3] Jennic - Technology for a changing world. *Co-existence of IEEE 802.15.4 at 2.4 GHz*. Application Note Revision 1.0, February 2008
- [4] O. Gnawali, R. Fonseca, K. Jamieson, D. Moss, P. Levis. *Collection tree protocol*, Proceedings of the 7th ACM Conference on Embedded Networked Sensor Systems, SenSys '09, pages 1–14, New York, NY, USA, 2009

- [5] C. A. Boano, T. Voigt, N. Tsiftes, L. Mottola, K. Römer, M. A. Zuniga. *Making sensor net mac protocols robust against interference*, Proceedings of the 7th European Conference on Wireless Sensor Networks, Coimbra, Portugal, February 2010
- [6] M. Buettner, G. Yee, E. Anderson, R. Ha.: *X-MAC: A short preamble MAC protocol for duty-cycled wireless sensor networks*, Proceedings of the 4th international conference on Embedded networked sensor systems, SenSys '06, 2006
- [7] M.-E. Razvan, C.-J. M. Liang, A. Terzis. *Koala: Ultra-low power data retrieval in wireless sensor networks*, Proceedings of the 7th international conference on Information processing in sensor networks, IPSN '08, pages 421–432, Washington, DC, USA, 2008
- [8] K. Klues, D. Moss, J. Hui. *Tep 105 -low power listening*, <http://www.tinyos.net/tinyos-2.x/doc/html/tep105.html>, last visited April 2011
- [9] T. Voigt, F. Österlind. *Coredac: Collision-free command-response data collection*, 13th IEEE International Conference on Emerging Technologies and Factory Automation, Hamburg, Germany, September 2008
- [10] A. Roy, N. Sarma. *Energy saving in mac layer of wireless sensor networks: a survey*, In National Workshop in Design and Analysis of Algorithm (NWDAA), India, 2010
- [11] I. Demirkol, C. Ersoy, F. Alagoz. *Mac protocols for wireless sensor networks: a survey*, Communications Magazine, *IEEE*, 44(4):115 – 121, April 2006
- [12] MEMSIC Inc. (formerly Crossbow): *TelosB Mote Platform Datasheet*, 2010
- [13] A. Dunkels, F. Österlind, N. Tsiftes, Z. He. *Software-based on-line energy estimation for sensor nodes*, Proceedings of the fourth workshop on Embedded Networked Sensors (Emnets IV), Cork, Ireland, June 2007
- [14] A. Prayati, C. Antonopoulos, T. Stoyanova, C. Koullamas, G. Papadopoulos: *A modeling approach on the telosb wsn platform power consumption*, Journal of Systems and Software, 83(8):1355 – 1363, 2010

Accepted ASIM SST Wismar, May 2011

Submitted: May 2011

Accepted November 10, 2011

Application of the Fourier Analysis for the Validation and Optimisation of Discrete Event Models

Hans-Peter Barbey

Bielefeld University of Applied Sciences, Wilhelm-Bertelsmann-Strasse 10, 33602 Bielefeld, Germany;
hans-peter.barbey@fh-bielefeld.de

Abstract. Logistic systems can be designed as push-systems or pull-systems. In a pull-system, one parameter, e.g. the stock items have to be closed-loop controlled. It will be shown that the closed-loop controlled model can work in an unstable manner like a ‘logistic oscillating circuit’. This behaviour is a part of the bullwhip effect, which occurs typically in supply-chains. In comparison with a closed-loop controlled electronic system, the elements of a logistic system have relatively long dead times. In discrete event simulation, there is no method to optimally calculate the parameters of the system also taking account of the dead times. Furthermore, there is no validation technique to date, which can determine the unstable behaviour of a system. In many different areas of engineering, the FFT analysis is a frequently used method. It will be shown that the FFT analysis is a suitable method to determine the unstable behaviour of discrete event simulation models. However, FFT analysis is only a method to determine the unstable behaviour; the elimination can only be done by trial and error.

Introduction

Discrete event simulation is a frequently used method for designing new, complex production systems. The advantage of this method is that all elements of the system can be described with only a few parameters. Objectives of such a simulation study are to obtain knowledge of, for example, cycle times or utilisation of the machinery. There are numerous commercially available programs for this.

The execution of a complete simulation study is described in VDI 3633 [4]. An important point within a simulation study is the validation of the model and the results. There is no generally applicable guideline for this. Depending on the particular project, different methods can be applied. Table 1 presents a summary of all methods according Rabe et al [3].

1 Characteristics of a Closed-loop Controlled System

Push-systems are often used for the management of a production system. These systems are producing goods without a customer order. Therefore, the stock in such a system is relatively high. To reduce stock, a pull-system is the better solution. Here, the production only starts on demand. The higher the demand, the faster is the production rate. These systems are closed-loop controlled. These closed-loop controlled systems can of course also be designed using discrete event simulation. As there is usually no special module for this, the controller has to be designed using a special program code.

First, it is necessary to point out the differences between a logistics closed-loop controlled system and closed-loop controlled systems in for example automation technology. In the automation technology, the systems are designed using electronic modules. The signals in these systems are therefore electric currents or voltages. Therefore the speed of the signals is practically infinite.

In contrast, the speed of the signal in a logistics system is very low. The speed of a conveyor is low or the processing time on a production machine is high. Thus, the speed of the signal which is connected with the flow of objects through the production system is very low. Described in terms of control technology, the time difference between the entry of an object or signal to a machine and the exit is the dead time.

It is generally known that dead times in a closed-loop controlled system can result in oscillations and thus unstable systems. There are methods in control technology to design the parameters of a system so that these oscillations can be prevented. These methods could not be applied in the discrete event simulation due to missing mathematical relationship between the system parameters.

	Target description	Task specification	Concept model	Formal model	Executable model	Simulation results	Basic Data	Processed Data
Animation					X	X		
Review	X	X	X	X	X	X	X	X
Dimensional Consistency test				X	X	X	X	X
Event validity test					X			
Fixed value test				X	X	X		
Extreme condition test				X	X	X		X
Monitoring					X	X		X
Desk checking	X	X	X	X	X	X	X	X
Sensitivity Analysis					X	X		X
Statistical Techniques					X	X	X	X
Structural walkthrough	X	X	X	X	X	X	X	X
Internal validity test					X	X		
Sub model testing			X	X	X			
Trace analysis					X			
Turing test					X			
Cause-effect graph			X	X	X			
Face validity	X	X	X	X	X	X	X	X
Predictive validation					X			
Comparison to other models					X	X		
Historical data validation					X			

Table 1. Validation methods (according to Rabe et al.).

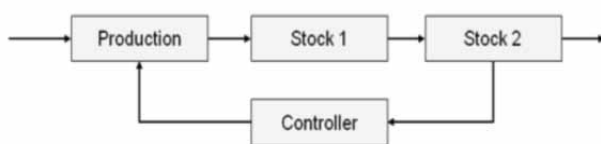

Figure 1. Simple closed-loop controlled production system.

2 Design of an Unstable Closed-loop Controlled System

First, it is necessary to demonstrate, that unstable behaviour can also occur in logistics systems. A very simple model will be designed for this (Figure 1): The production system delivers the goods to a stock 1. This stock has a constant storage time, e.g. for cooling. Then the items are stored in a stock 2, e.g. for distribution.

The stock output rate is constant. The difference between the current stock and the target stock is the parameter which controls the production cycle time. The higher the difference, the faster is the production (Figure 1). The system is designed with the following parameters:

- The cycle time of the production is closed-loop controlled
- The production has an infinite capacity
- The storage time of stock 1 is 1 day
- The target stock is 15 units for stock 2
- Both stocks have an infinite capacity
- The stock output rate of stock 2 is constant at 1 unit/4.8 h

This system is closed-loop controlled by a controller with the following characteristics:

- The current stock is recorded once per day
- The cycle time of the production is calculated with a delay of one half day
- The difference of the stock is fed into the production system on the next day

A discrete event model is created using these values (Figure 2). A similar model is presented in Barbey [1].

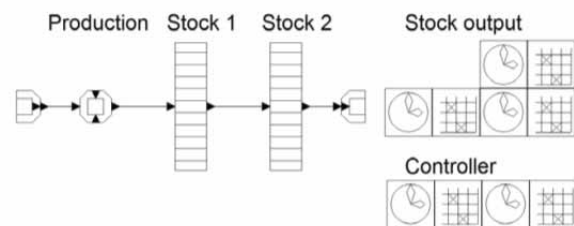

Figure 2. Discrete event model designed with DOSIMIS.

3 Validation and Results

In the following diagram the results for the stock are recorded over a period of 5 weeks. At the very beginning, the controller is switched off.

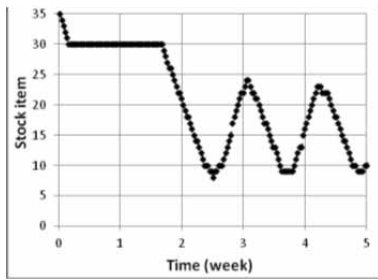

Figure 3. Stock of the first model.

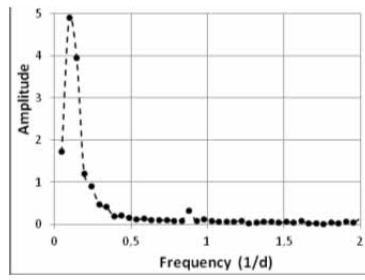

Figure 4. FFT analysis with Excel for the first model.

The stock has a constant figure of 30 units here. After approx. two weeks, the controller is switched on. Then the stock has on average the target value. However, it is overlaid with an oscillation with an amplitude of 7 units (Figure 3).

This model demonstrates that unstable behaviour in logistics systems can occur if an unsuitable set of parameters is applied. All input parameters are constant, but the stock is only constant on average.

The model is acting like a 'logistic oscillating circuit'. This behaviour is a part of the bullwhip effect, which is a typical behaviour in supply-chains.

If unstable behaviour can be produced in one model, then it is also possible to produce unstable behaviour in any other model. Therefore, validation of the model is an important issue.

According to Table 1, there are many validation methods which can be applied. However, only the reviewing of the results is suitable for this model. However, this model has been designed as simple as possible with the only objective of indicating an error: in this case unstable behaviour. It is also obvious that this error will be found with the selected validation methods. However, the models are generally much more complex and the unstable behaviour is thus possibly not immediately visible.

All the methods in Table 1 can find almost any kind of error in discrete simulation models, but they are not suitable for detecting unstable behaviour. Therefore, a new validation method must be found. In many areas of engineering, the Fourier analysis is a frequently used method to analyse dynamic processes. This method states that each periodic signal can be compiled from a sum of sine and cosine-functions. The Fast-Fourier-Transform (FFT) is a special form of the Fourier analysis. The mathematical theory for this method is described in Brigham [2].

The Fourier analysis is initially applied to the described model. The results of the Fourier analysis which have been produced here using Excel are shown in Figure 4. The frequency range was analysed up to a frequency of 2 1/d. There is only one peak at a frequency of approx. 0.12 1/d. The same result can be obtained from the consideration of Figure 3. This frequency is the characteristic frequency of the un-

stable system. The application of the Fourier analysis to this simple model demonstrates that this method is suitable for the validation of discrete event models.

Chapter 2 illustrates the application of a new validation method to a very simple model. Normally, models are significantly more complex. Therefore, this simple model will be somewhat modified in the following.

Two parameters are changed in the next model:

- The current stock is recorded once per day and the cycle time of the production is calculated immediately
- There is an additional stock output each 1.4d. The additional output is a random number between 4 and 8.

The results are shown in Figure 5. The result still seems to be periodic. There must be a periodic part in, because the additional stock output is periodic. But there is no method according to Table 1 in this case which detects the unstable behaviour of the model. The unstable behaviour is also not visible in Figure 5. Therefore, the Fourier analysis is now applied to these results. The diagram in Figure 6 shows some typical characteristics of the model.

There is one peak at a frequency of 0.7 1/d. This is related to the additional output which has exactly this frequency. A second peak is at a frequency of 1.4 1/d which is double the frequency of the stock output. An extension of the frequency range would show additional peaks at all frequency multiples of the output. However, the largest peak is at a frequency of 0.15 1/d. This frequency cannot be explained by the additional output; it is related to the unstable behaviour of the model itself.

Using the frequency analysis, it is possible to determine the unstable behaviour of a model. For this, each characteristic frequency has to be compared with the parameters of the model. In this case, the additional output is a parameter which produces a periodic signal. Therefore, this frequency and its multiples can be excluded.

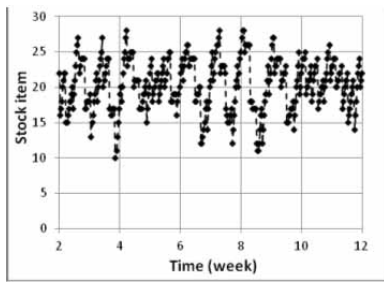

Figure 5. Stock with additional output.

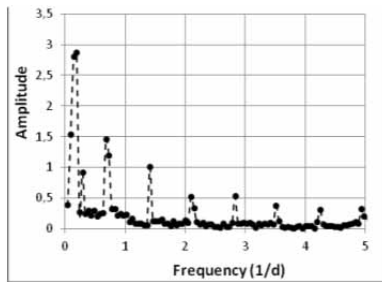

Figure 6. FFT analysis with an additional output.

The peak at a frequency of 0.15 1/d is clearly reduced but still exists. All other peaks caused by the additional stock output are still there. An additional simulation with this model without the additional output shows the improvement actually achieved (Figure 9).

Figure 3 shows a permanent oscillation after the controller is switched on. In contrast, Figure 9 only shows one oscillation. The signal then has a constant value of 15 and the bullwhip-effect is reduced. This demonstrates an improvement, but the optimum has not yet been reached. Therefore, further variation of the parameters has to be done. This procedure shows that the Fourier analysis is suitable for finding the instability of a model and optimising it afterwards.

All other frequencies which could not be explained by the parameters of the model show an unstable behaviour of the model.

However, the unstable behaviour cannot be eliminated using the Fourier analysis as there is no functional relationship between the model parameters.

The elimination of the unstable behaviour can only be realised by trial and error. A variation of the model parameters and a following Fourier analysis shows whether the results are satisfactory.

4 Optimisation

Optimisation is always project-specific. Each model has a specific set of parameters which can be changed individually. The model is now only used to demonstrate how unstable behaviour can be eliminated by using the Fourier analysis.

In the original model, the controller was designed so that the difference in the stock is supplied by the transport system to the production system on the next day. Now the controller will be modified so that only one third of the difference will be supplied to the production system on the next day. Figure 7 shows the stock with the modified controller. Compared with Figure 5, the fluctuation of the stock is reduced. Figure 8 shows the Fourier analysis for this.

References

- [1] H. P. Barbey. *Simulation des Stabilitätsverhaltens von Produktionssystemen am Beispiel einer lagerbestandsge-regelten Produktion*. Proceedings of the 2008 ASIM-conference, Berlin.
- [2] E. O. Brigham. *FFT-Anwendungen*. R.Oldenburger Verlag, München, 1997.
- [3] M. Rabe, S. Spiekermann, S. Wenzel. *Verifikation und Validierung in Produktion und Logistik*. Springer Verlag, Berlin – Heidelberg 2008.
- [4] VDI 3633. *Simulation von Logistik-, Materialfluss- und Produktionssystemen*. 2000, Beuth Verlag, Berlin.

Accepted ASIM SST Winterthur, September 2011
 Submitted: September 2011
 Accepted November 10, 2011

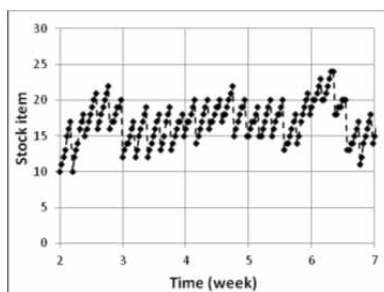

Figure 7. Stock with the modified controller.

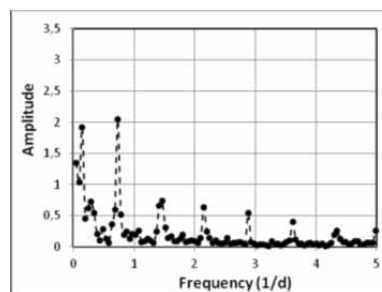

Figure 8. FFT analysis of the modified model.

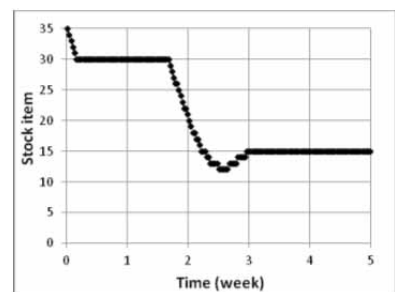

Figure 9. Stock without the additional output.

ARGESIM Benchmark C20 ‘Complex Production System’ – Definition and Call

Sebastian Schreiber, Alexander Fay*

Helmut Schmidt University / University of the Federal Armed Forces Hamburg, Institute of Automation Technology, Holstenhofweg 85, 22043 Hamburg, Germany; 85, *alexander.fay@hsu-hh.de; ARGESIM-C20@hsu-hh.de

Abstract. ARGESIM provides several different benchmarks for modelling and simulation. Unfortunately, the only benchmark that can be used as a foundation for analyzing manufacturing control systems, ARGESIM C2 ‘Flexible Assembly System’, does not cover today’s requirements for comparing different simulation techniques and/or control algorithms regarding complexity and dynamics. Therefore, the authors propose a new benchmark description: ARGESIM Benchmark C20 ‘Complex Production System’. The benchmark is based on two dimensions, defining a total of twelve different scenarios that differ in their complexity and dynamic behavior.

Introduction

Today’s manufacturing systems show an increasing level of complexity and a growing demand for more system flexibility. To test and compare new algorithms that tackle this challenge, properly defined ‘reference systems’ are required, especially in the research community of manufacturing control systems. Leitão [1] and Valckenaers et al. [2] underpin this prevalent lack of ‘reference systems’, i.e. physical systems (test-beds) and/or virtual systems (simulation models).

ARGESIM provides a set of different benchmarks with focus on modelling and simulation of several research fields. Unfortunately, the only benchmark that covers material flow or production system problems – C2 ‘Flexible Assembly System’ (first proposed in July 1991) – does not cover today’s complexity and dynamics, as already shown in [3]. Therefore, this benchmark seems to be less suitable for testing or comparing of current modelling and simulation techniques and/or software. For that reason, the authors developed an advanced reference system that covers today’s challenges. The proposed system ARGESIM C20 ‘Complex Production System’ is an extended and revised version of the reference system described in [4]. For further details regarding the development and the theoretical founda-

tion of the system’s structure and dynamics, we refer to [4] and [5].

For easier reading and better understanding, this benchmark description is divided into two parts. The first part describes the general problem definition, the second compiles all parameters and settings in detail within the Appendix.

The first part is structured according to the framework dimensions presented by Terzi et al. [6] (see also Figure 1). Section 1 describes the reference system regarding its static structure as a ‘Production System Model’, Section 2 is concerned with its dynamic behaviour as a ‘Manufacturing Scenario’. In addition, the ‘Measurement of Performance’ for this system is described in Section 3, which is also used to formulate tasks for comparison. In Section 4, guidelines for publishing solutions based on this description are given. The Appendix is divided into five sections: (A) physical resources, (B) process plan, (C) system layout, (D) Operational Scenario, and (E) Plant Scenario.

1 Production System Model

The benchmark is based on a fixed system layout, as shown in Figure 2. The manufacturing system consists of a central transport system based on conveyors with an inner and an outer cycle, mono-directional traffic, and a constant conveyor speed. The processors are placed within ‘processing areas’ which are connected to the outer cycle, each with one input and one output port. Orders are represented as parts within the system, where each order consists of exactly one part. Pallets or either carriers can be used to move them through the system.

1.1 Physical resources

The system consists of five different types of work stations (WS). Each WS type is able to process a defined set of operations. The WS abilities vary from only one operation (WS type I to IV) to multiple operations (WS

type V). Some WS types have special abilities, like tool abrasion, or they differ in their age (‘generation’). The types, quantities, and abilities of the WSs are listed in Appendix A (see Table 2). All WS types are subject to disruption.

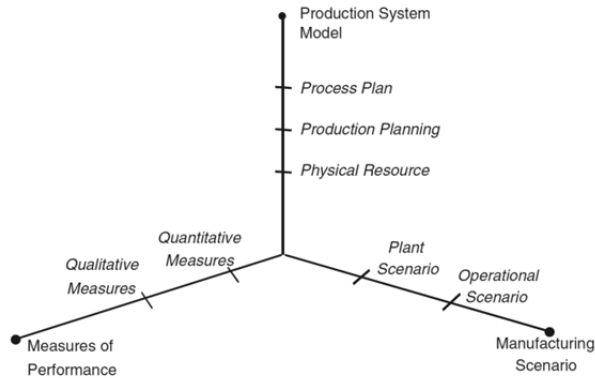

Figure 1. Framework dimensions for the description of the benchmark (taken from [6], Figure 2).

The system’s general topology is shown in Figure 2, where processing area 0 represents system input and output. Here, parts are loaded and unloaded, and NOK (‘not-okay’) parts are discharged. The other three processing areas are divided into a buffering area and a manufacturing cell. Figure 4 and Figure 5 in Appendix C provide a detailed view of the layout including dimensioning.

The transport system is represented through conveyors and junctions. The amount of parts that can be carried by a conveyor depends on its length. In contrast, each junction can hold only one part at a time and represents a decision point. Junctions are represented as a dot within the figures. The sections of the central transport system are clustered into three groups (A to C) by their influence to the system in case of a disruption (see also Figure 2).

1.2 Production planning

Order books define the production planning. Each order book contains a fixed number of orders. The orders in an order book follow a probability distribution.

Thus, order books are similar regarding the distribution parameters and order book size (number of orders), but differ with respect to the individual orders. The general order book definition is summarized in Appendix D (see also Table 2). Each order is defined by its product type, earliest release date, due date, appearance date, and rush order flag. The appearance date is an important parameter for the planning horizon of an algorithm and will be discussed later, as well as the need for a rush order flag.

In [7], Law distinguishes between ‘terminating’ and ‘nonterminating simulations’. Terminating simulations are characterized by a pre-defined point of termination, e.g. number of events, while nonterminating simulations have a continuous input and, in most cases, are characterized by some kind of steady-state behaviour. The indicators that can be analyzed during a simulation study differ for these different kinds of simulations, e.g. makespan is an indicator that is only defined for terminating simulations. Usually, nonterminating simulations can be described by an ‘initialisation phase’ and a ‘steady-state phase’ in which the system behaves nearly stable. For analyzing steady-state parameters, a steady-state phase of a length of three to six times the initialisation phase is considered necessary according to different authors’ views [8].

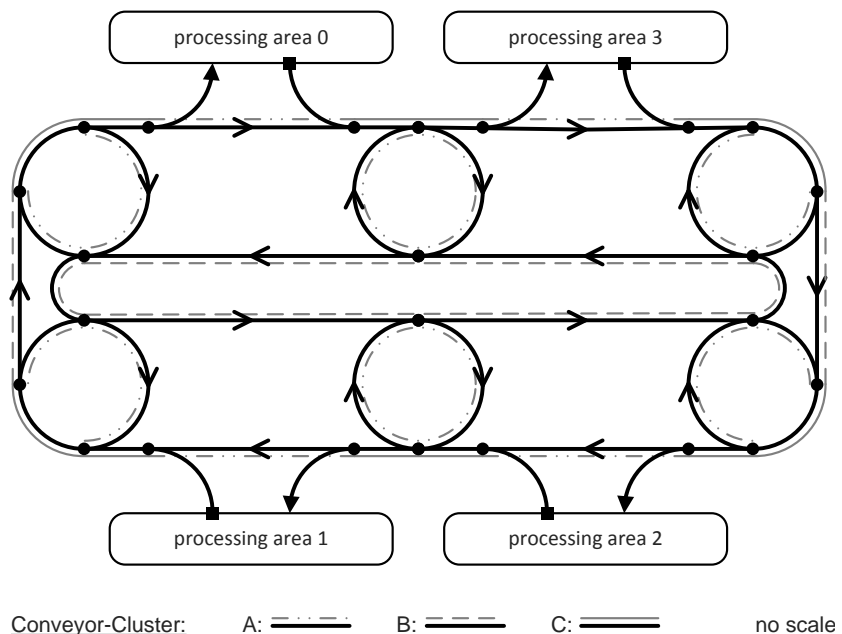

Figure 2. General layout of the proposed reference system with clustering of conveyors (based on [4], Figure 1(a)): without scale.

The current specification of this benchmark describes a terminating simulation study that terminates when all orders of an order book are finished. For analyzing the system under nonterminating aspects, this order book size should be sufficiently large. Investigations during validation of this benchmark have shown that the initialisation phase for this system has a length of about 1,000 orders, depending on the implemented control algorithm.

1.3 Process plan

The system processes five different product types (A to E). The product type definitions are summarized in Appendix B (see Table 2). Product types differ in their complexity, especially with regard to the operations (O1 to O6) that need to be processed and the possible sequences of these operations. The operation O1 can be interpreted as a quality control process and may occur more than once. In addition, some operations introduce pre-process constraints to the process plan:

- **[MIN]** The successor of an operation cannot be processed before a given period of time has elapsed (e.g. drying process).
- **[MAX NOK]** The time between the end of one operation and the start of the next must not exceed a given period of time, otherwise, parts need to be discharged as NOK and need to be rescheduled (e.g. dry adhesive).
- **[MAX OK]** The predecessor operation can be repeated if the time between the end of an operation and the start of the next exceeds a given period of time. Thus, the part must not be discharged as NOK (e.g. heating/re-heating process).

2 Manufacturing Scenario

In [5], three Complexity Dimensions and their complexity levels are defined to describe the dynamic environment for a reference system: 'Operational Scenario' (OSc) with three different complexity levels, 'Plant Scenario' (PSc) with four different complexity levels, and 'Transport System Complexity Dimension' with three different complexity levels. To reduce the benchmark's complexity, only the first two dimensions are adopted for this proposed system. These are related to the framework dimension Manufacturing Scenario (according to [6]), more specifically to the Operational Scenario and Plant Scenario levels (see also Figure 1).

For a detailed description of the Complexity Dimensions see [5].

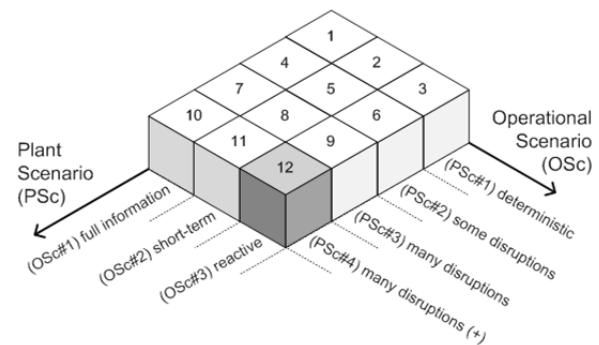

Figure 3: Design of experiments described by the two dimensions 'Operational Scenario (OSc)' and 'Plant Scenario (PSc)' (based on [5], Figure 2).

The Complexity Dimensions proposed by the authors cover dynamic effects caused by order release, order specification, and processor downtime, and are all built upon an identical benchmark system's structure. They describe a total of twelve different scenarios, representing the experiment designs (Figure 3) to be investigated for comparison. First, the OSc defines the stochastic workload for the system. Second, the stochastic behaviour of the manufacturing system itself is described as the PSc.

In the following, a distinction between the different scenarios for each of the two dimensions is given, enumerated as OSc#(1..3) and PSc#(1..4). Each combination of these two dimensions defines a manufacturing scenario for the reference system. They are numbered consecutively from 1 to 12 for better comparison, as shown in Figure 3. As an example, the highlighted block in this figure describes Scenario 12 with no information ahead of time about the system's workload and the worst case regarding the internal dynamic behaviour, with many disruptions.

2.1 Operational Scenario (OSc)

Variations of the order mix are part of the OSc. The OSc describes 'appearance dates', i.e., the time at which individual orders appear on the planning horizon in relation to their individual release dates. An order book represents external effects only. Therefore, it should be generated independently from the control algorithm and used as an input for the control system. Some orders are generated with a rush order flag, which needs to be taken into account depending on the OSc level.

When a rush order is released, its due date is influenced (decreased) in a predefined way.

Three different OSc levels should be analysed: an environment with full information about all order release dates at the beginning of a simulation run and no occurrence of rush orders (OSc#1), a short-term environment with medium decrease of rush order due dates and a defined appearance date (OSc#2), and a purely reactive environment with an appearance date of zero (i.e., the orders appear at their release date; thus, the planning horizon equals zero), and a high decrease in rush order due dates (OSc#3). The parameters for the Operational Scenario are summarized in Appendix D (see Table 3).

2.2 Plant Scenario (PSc)

The PSc levels differ in their complexity, i.e. the level of dynamic behaviour of the environment. They are described by 2-tupels MTBF/MTTR (mean time between failure/mean time to repair).

PSc#1 represents a fully deterministic behaviour with no occurrence of disruptions. PSc#2 and PSc#3 only differ in their MTBF, where the former represents behaviour with few disruptions, i.e. high means and low variances, while the latter represents behaviour with many disruptions, i.e. lower means and higher variances.

The fourth level PSc#4 represents the worst case within this reference system. It expands PSc#3 with the possibility of failures of some transport system elements. This introduces the need for rerouting to prevent a system blockade. For the exact distributions and parameters for MTBF/MTTR see Table 5 in Appendix E.

3 Measures of Performance (Tasks for Benchmark)

Many different indicators are reported in the literature to measure the performance of production systems, particularly in the research area of scheduling (e.g. [9]). For presentation of results, median and interquartile range IQR ($IQR = Q_{.75} - Q_{.25}$) should be used as robust statistics. The authors consider the following indicators as suitable performance criteria to compare different algorithms:

Criteria – Task A: Makespan. Median and IQR value of the makespan of the order books for all scenarios.

Criteria – Task B: Throughput Time. Median and IQR value of the throughput time of the orders, i.e. each from release date to sink.

Criteria – Task C: Tardiness. Based on the due dates, the number of tardy jobs and the (weighted) tardiness, summarized as median and IQR value for the order books. For this, the required individual weights for each product type are listed in Appendix B, Table 2 (10).

Criteria – Task D: Violated Constraints. Median, and IQR value of the number of [MAX NOK] and [MAX OK] parts generated during each simulation run.

All tasks should be performed with at least ten runs of simulation experiments and by use of several order books to analyze system behaviour with different sets of internal and external conditions.

4 Guidelines for Presenting Solutions

If questions or remarks come up during modelling, simulation, or interpretation of this reference system, please feel free to contact the authors or have a look at the ARGESIM homepage, where you can find comprehensive information and three order books in CSV format as a reference for comparison.

Solutions (to be sent by email to sne@argesim.org, office@sne-journal.org) would ideally be accompanied by detailed documentation and source code of the simulation model and/or the control algorithm. Such information would be made available on the ARGESIM server under the current software license terms. The solution should use than four to six pages SNE and cover the following aspects (with general layout as technical notes, not as 2-page layout for 'short' comparison solutions..

Authors are asked to give an overview of the

- **Simulator** and its capabilities used, esp. with regard to analysis of simulation runs,
- **Modelling** of the implemented system and modelling techniques used, and
- **Control Algorithm** used for controlling this system and its location with regard to the simulator (embedded/external).

For presenting the results of their solutions with respect to the mentioned criteria, we encourage authors to use tables and figures as appropriate. The set of the four tasks described in Section 3 can only be regarded as an initial set for analyzing the system's behaviour. Authors should feel free to report additional indicators to analyze different effects that they regard as suitable for comparison.

References

- [1] P. Leitão. *Agent-based distributed manufacturing control: A state-of-the-art survey*. Engineering Applications of Artificial Intelligence, vol. 22 (7), pp. 979–91, 2009.
- [2] P. Valckenaers, et al., *A benchmarking service for the manufacturing control research community*. Journal of Intelligent Manufacturing, vol. 17 (6), pp. 667–79, 2006.
- [3] S. Schreiber, M. Barth, R. Nicolaus, M. Schlegel, A. Fay. *Event-based and State-Automata-based Modeling of FMS - A Comparative Case Study of Flexsim, Dymola and Matlab/Stateflow based on the ARGESIM Benchmark C2*. Simulation News Europe, vol. 20 (1), pp. 38–44, 2010.
- [4] S. Schreiber, A. Fay. *A reference system for the benchmarking of manufacturing control systems*. Proc. of the 16th IEEE-ETFA Conference, 2011.
- [5] S. Schreiber, A. Fay. *Requirements for the benchmarking of decentralized manufacturing control systems*. Proc. of the 16th IEEE-ETFA Conference, 2011.
- [6] S. Terzi, S. Cavalieri, M. Macchi, M. Garetti, H. Panetto. *Development of a Reference Architecture for Benchmarking Service of Manufacturing Systems*. 7th IFAC workshop on Intell. manuf. systems, pp. 193–200, 2003.
- [7] A. M. Law. *Simulation Modeling and Analysis*. 4th ed. Boston: McGraw-Hill, 2007.
- [8] O. A. Joseph, R. Sridharan. *Evaluation of routing flexibility of a flexible manufacturing system using simulation modelling and analysis*. The International Journal of Advanced Manufacturing Technology, vol. 56 (1-4), pp. 273–289, 2011.
- [9] V. Vinod, R. Sridharan. *Simulation modeling and analysis of due-date assignment methods and scheduling decision rules in a dynamic job shop production system*. International Journal of Production Economics, vol. 129 (1), pp. 127–46, 2011.

Received: August 30, 2011
 Revised: October 16, 2011
 Accepted: November 15, 2011

WS Type (1)	WS no. (gen.) (2)	Operation Capability (3)	Product Type/ Process Time [s] (4)	Processing Area (5)	Additional Remarks (6)
I	I.1, I.2	O1	A-E / 20	1.1, 1.4	
	I.3, I.4			2.1, 2.5	
	I.5, I.6			3.1, 3.4	
II	II.1, II.2 (1st)	O2	A-B / 30	1.2, 1.3	WS instances of the later generation can handle more product types and have shorter process time
	II.3 (2nd)	O2	A-D / 27	1.5	
	II.4 (3rd)	O2	A-E / 24	1.6	
III	III.1, III.2, III.3	O3	B / 40 C-D / 44 E / 50	2.2, 2.3, 2.4	tool replacement after 2,500 s of processing time, takes 120 s
IV	IV.1, IV.2	O6	E / 120	3.2, 3.3	
V	V.1, V.2	O4, O5	C-D / 60 E / 90	2.6, 2.7	setup time of 300 s for switching operation
	V.3, V.4			3.5, 3.6	

Table 1: Technical characteristics of the system and work stations (based on [4], Table 1).

APPENDIX A - Physical Resources

Appendix A lists all detailed definitions and parameters for the physical resources of the benchmark system. The layout and its dimensions are part of Appendix C. The conveyor speed is 1 m/s and parts have a length of 1 meter. Thus, a conveyor that is 10 meters long can transport a maximum of 10 parts simultaneously.

Definition of workstations.

The technical characteristics of the system and definitions of work stations are summarized in Table 2, where columns list:

- (1) the five different WS types,
- (2) the instances of each WS type,
- (3) operations for each of the WS instance,

- (4) product types and the required process times for each WS type (the row of WS type II is subdivided into three different generations),
- (5) location of each WS within the system, according to the enumeration of Figure 5,
- (6) and special abilities of some WS types. During tool change or operation change, parts are not allowed to stay inside the WS.

Disruptions of workstations

Instances of WS type I do not cause any damage to the part and thus the process can be continued at the end of a disruption. All other WS types damage the part inside in case of a disruption, so that the part is classified as NOK and needs to be processed accordingly. The parameters for the disruption profiles are listed in Appendix D, Table 5.

(1) Product Type	A	B	C	D	E	Remarks
(2) Earliest Release Date	exponential distribution with parameter $\lambda = 15$ s/pc.					describes the inter-arrival time of orders
(3) Due Date	a = 13 b = 20	a = 10 b = 12	a = 9 b = 26	a = 7 b = 10	a = 6 b = 10	RWK method with parameters a and b
(4) Appearance Date	depends on Operation Scenario, see Table 3					
(5) Rush Order Flag	0 %	10 %	20 %	20 %	20 %	2-level distribution (rush order %), each
(6) Distribution of Product Types	40 %	25 %	10 %	10 %	15 %	5-level distribution (in total)
(7) Operations Needed	O1, O2	O1, O2, O3	O1, O2, O3, O4	O1, O2, O3, O5	O1, O2, O3, O5, O6	
(8) Sequence of Operations (Process Plan)	O2 → O1	O2 → O1 → O3 → O1	O2 → O1 → O4 → O3 → O1	O2 → O1 → O5 → O3 → O1	O2 → O1 → O6 → O5 → O3 → O1	alternative process plans for product types B to E
		O3 → O1 → O2 → O1	O4 → O3 → O1 → O2 → O1	O5 → O3 → O1 → O2 → O1	O6 → O5 → O3 → O1 → O2 → O1	
(9) Pre-process Time Constraints [s]	none	none		600	600	O5 → [min] → O3
			360			O4 → [max NOK] → O3
					300	O6 → [max OK] → O5
(10) Product Weight	0.40	.90	1.42	1.42	2.21	for weighted tardiness

Table 2: Product type definition: specifies order book and sequences of operation (based on [4], Table 2).

APPENDIX B - Process Plan

Appendix B lists detailed definitions and parameters for process plan and products. These definitions also impact the settings for order books for this benchmark, which is part of Appendix D.

Definition of products.

Each product type differs in its complexity as shown in Table 2, where each order is defined by (1) a product type, (2) an earliest release date, (3) a due date, (4) an appearance date, and (5) a rush order flag. In addition, the (7) operations that need to be processed and (8) possible sequences of these operations are listed. Some operations include pre-process time constraints, as shown in column (9):

- [MIN]: between O5 and O3,
- [MAX NOK]: between O4 and O3, and
- [MAX OK]: between O6 and O5.

Due date parameters

The due date for each order is defined according to the 'random work content (RWK) method' provided in [9], which calculates due dates depending on the arrival time of an order, its total processing time, and a uniform distributed factor, as shown in the following equation:

$$D_i = A_i + U(a, b) \sum_{j=1}^{n_i} p_{ij}$$

In this equation (see [9], p. 131):

- D_i represents the due date of order i ,
- A_i the arrival time of order i in the shop,
- p_{ij} the processing time of operation j of order i ,
- n_i the number of operation in order i , and
- a and b are parameters for the uniform distribution $U(a, b)$.

Because of the unequal ratios of processing time to necessary transportation time for different product types, these distribution parameters a and b differ for the product types (see Table 2 (3))

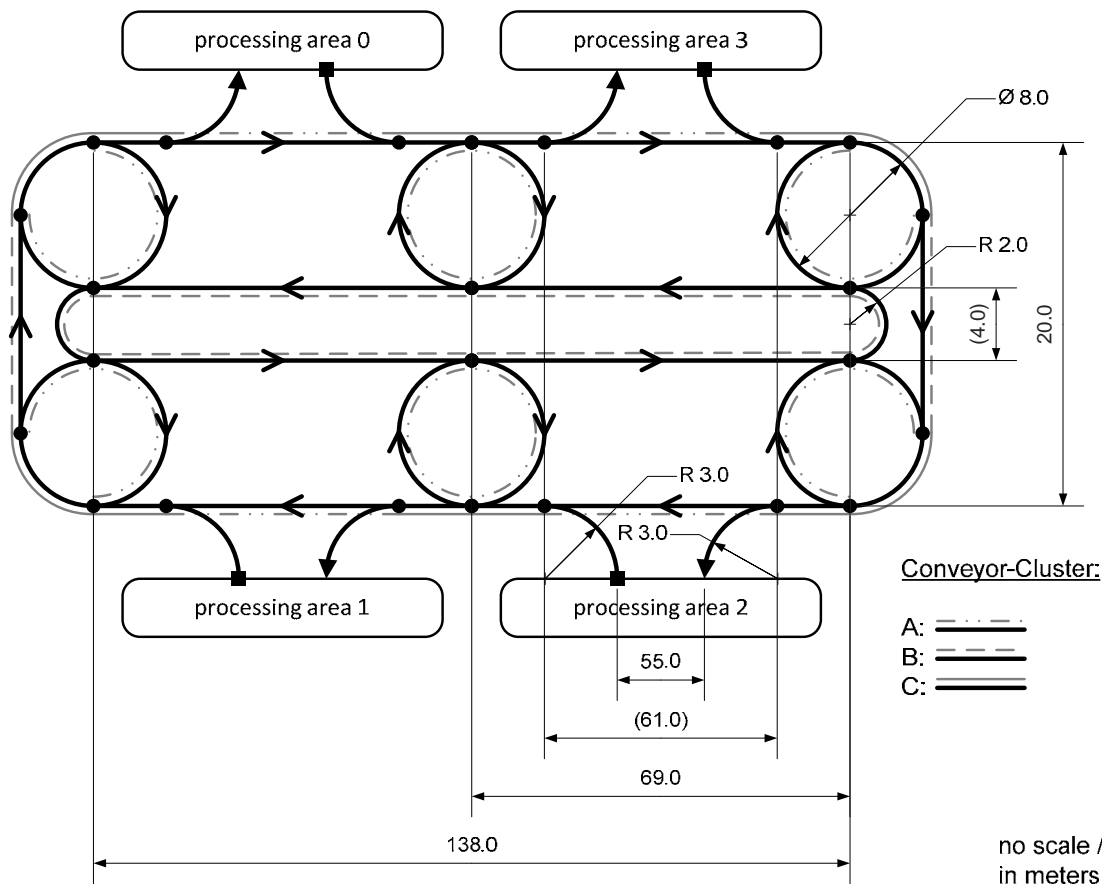

Figure 4. Layout of the reference system (based on [4], Figure 1(a)): dimensions are in meters and without scale.

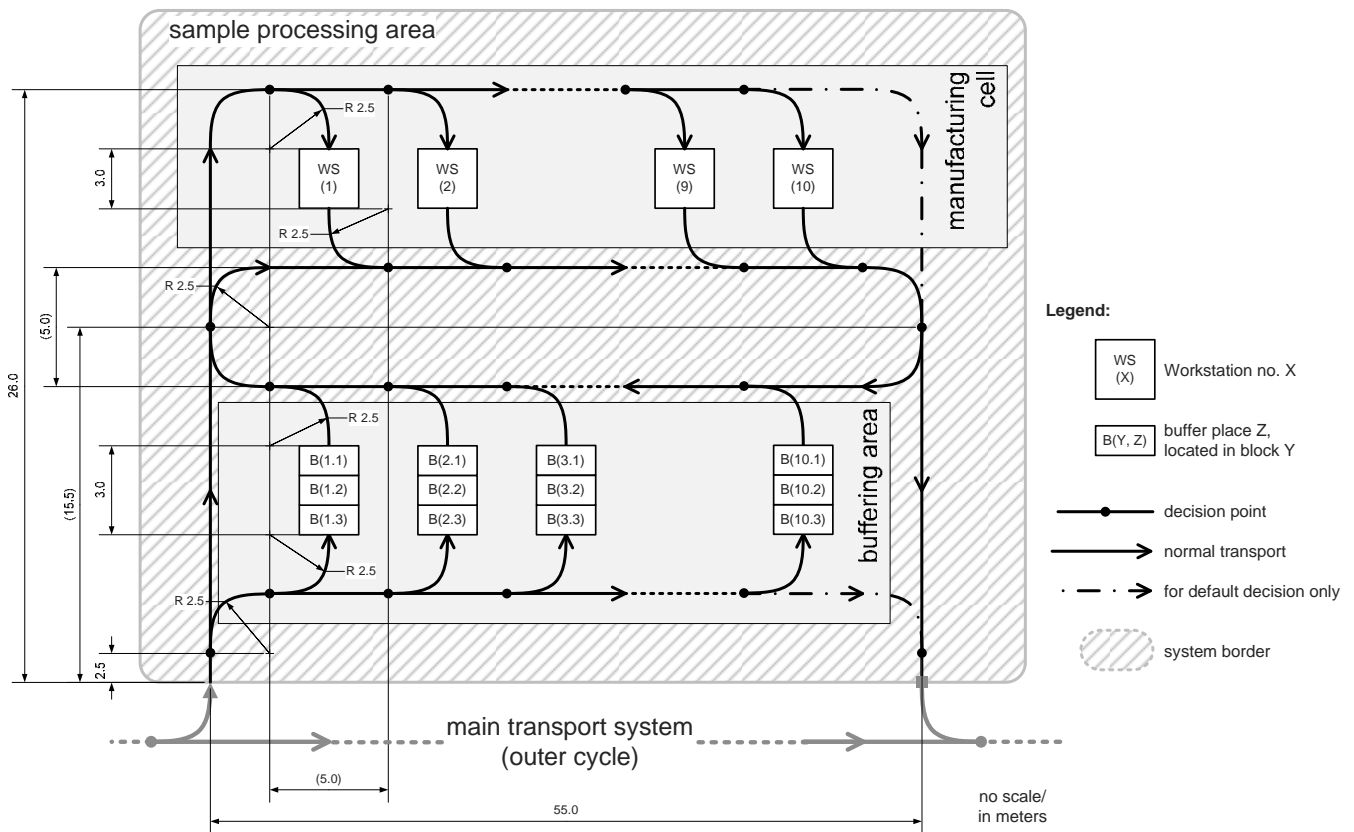

Figure 5. Layout of a sample processing area (based on [4], Figure 1(b)): dimensions are in meters and without scale.

Appendix C - System Layout

The dimensions for the system layout are given in Figure 4 and Figure 5, given in meters. The system layout is designed in a way that it can be modularly extended (a) within a processing area or (b) through the main transport system.

A part which enters a processing area can either move to one of the buffer places or bypass the buffers and move directly to an idle WS. Buffers are used as local processing buffers for parts either waiting for processing or waiting due to pre-process conditions.

The clustering in Figure 4 is related to the whole track, from one dot to the next one. If a modeller decided to model these elements by use of several objects, the probabilities for disruption would need to be divided too.

	OSc#1 (D.1.1)	OSc#2 (D.1.2)	OSc#3 (D.1.3)	Remarks
(1) appearance date [s]	= simulation start	= release date - (offset + $\phi(\alpha, \beta)$)	= release date	$\alpha = 29.4, \beta = 1.0,$ offset = 90.0
(2) rush orders/due date [s]	no decrease of due gap	decrease of due gap by 10%	decrease of due gap by 20%	due gap = due date - release date

Table 3. Specifications for Operational Scenario: due date based on RWK method (see Table 2 (3)) and appearance date based on gamma distribution $\phi(\alpha, \beta)$ with $\mu = \alpha \beta$ and $\sigma = \alpha \beta^2$ and $[\alpha] = [\beta] = [\text{offset}] = s$.

ID (1)	Product type (2)	Inter- arrival time (3)	Release date (4)	Due date OSc#1 (5)	Due date OSc#2 (6)	Due date OSc#3 (7)	App. date OSc#1 (8)	App. date OSc#2 (9)	App. date OSc#3 (10)	Rush order flag (11)
1	1	7.8	7.8	822.5	822.5	822.5	0	0	7.8	0
2	2	39.9	47.7	1525.5	1525.5	1525.5	0	0	47.7	0
...										
4999	4	9.9	78959.9	80886.6	80886.6	80886.6	0	78836.8	78959.9	0
5000	5	8	78967.9	81541.2	81283.8	81026.5	0	78844.8	78967.9	1

Table 4. Example of an order book following the requirements for Operational Scenarios OSc#1, OSc#2, and OSc#3.

Appendix D - Operational Scenario

The composition of an order book depends on the product types corresponding to a 5-level distribution defined in Table 2 (6) and a size of 5,000 orders. The parameters for the three Operational Scenario levels are listed in Table 3.

Appearance date

The appearance date is defined in Table 3 (1). For OSc#2, the appearance date is described by a gamma distributed factor with mean of 119.4 s, which is the theoretical average process time of an order. For the other scenarios it either equals zero (simulation start) or the order's release date.

Rush orders

A rush order decreases its due date, by a defined percentage (see Table 3 (2)) when reaching its release date.

Therefore, a percentage of the 'due gap' is used as the starting value.

Example for an order book

An example of an order book that covers the requirements listed above is shown in Table 4, where (1) lists individual order IDs and (2) lists the corresponding product type of this order. The release date (4) is based on the inter-arrival time (3). (5) to (7) list the due dates depending on the Operational Scenario.

The values are either identical if the Boolean rush order flag (11) is false, or decrease, as described above. The appearance date for each OSc level is listed in (8) to (10), where (8) is zero for all orders, i.e. full information at beginning, and (10) is equivalent with the corresponding release date (4) for each order.

	PSc#1 (D.2.1)	PSc#2 (D.2.2)	PSc#3 (D.2.3)	PSc#4 (D.2.4)	MTTR
WS type I	none	$\alpha = 4.450, \beta = 0.100$	$\alpha = 1.115, \beta = 0.200$		160
WS type II (1st gen.)		$\alpha = 2.400, \beta = 0.125$	$\alpha = 0.742, \beta = 0.225$		135
WS type II (2nd gen.)		$\alpha = 3.750, \beta = 0.100$	$\alpha = 0.940, \beta = 0.200$		135
WS type II (3rd gen.)		$\alpha = 15.000, \beta = 0.050$	$\alpha = 1.667, \beta = 0.150$		135
WS type III		$\alpha = 6.120, \beta = 0.100$	$\alpha = 1.530, \beta = 0.200$		220
WS type IV		$\alpha = 8.340, \beta = 0.100$	$\alpha = 2.085, \beta = 0.200$		365
WS type V		$\alpha = 10.140, \beta = 0.100$	$\alpha = 2.535, \beta = 0.100$		300
Conveyor	none			$\alpha = 2.000, \beta = 0.500$	600

Table 5. Plant scenario (PSc) specifications of MTBF for workstations and conveyors based on gamma distribution $\varphi(\alpha, \beta)$ with $\mu = \alpha \beta$ and $\sigma = \alpha \beta^2$ and $[\alpha] = [\beta] = h$, and a fix MTTR with $[MTTR] = s$.

APPENDIX E Plant Scenario

The four PSc levels are listed in Table 5 for the different WS types and conveyors, where α and β represent the parameters for gamma distribution. MTTR should be modelled as a constant time.

Disruptions for conveyors only occur during PSc#4 with an average frequency of one disruption per hour, and with only one transport system element affected at the same time. Because of the different influence of an element on system performance in case of a disruption, clustering of these elements is used, as already described above.

The selection of the next element to disrupt is done in two phases: (1) the conveyor cluster, based on a 3-level distribution with $\{A, B, C\} = \{.50, .35, .15\}$ is selected, and (2) one of the elements within this cluster is chosen, based on uniform distribution. Following this selection process should provide a nearly similar disruption profile through the simulation runs.

A Process-oriented Approach to ARGESIM Benchmark C2 'Flexible Assembly System' using AnyLogic with Java

Štefan Emrich^{1,*}, B. Malinowsky², Oliver Höftberger²

¹ Dept. Real Estate Development, Vienna University of Technology, Gusshausstrasse 28-30, 1040 Vienna, Austria

² Inst. f. Analysis and Scientific Computing, Vienna University of Technology; *stefan.emrich@tuwien.ac.at

Simulator. AnyLogic Advanced (educational version 6.2.0) is used for this comparison. The software allows simulation of discrete, continuous and hybrid systems. From version 6 on, the Integrated Development Environment (IDE) is built upon the Eclipse framework and uses a subset of design- and development features from the standard Eclipse Java IDE. Models are built using a graphical editor and can be accessed by using the Java programming language. Interaction is done through basic action-event notifications of library objects. Modification using Java data types is supported as well. AnyLogic is an object oriented simulator which generates Java code generated.

Modeling. Major parts of the model are built using the Enterprise Library of AnyLogic, its primary tool for discrete event modeling. The model consists of 8 almost identical subsystems which only differ in their respective setup- and timing-parameters. Thus in a first step an AnyLogic *active object class* **AssemblyStation** is created, which can be regarded as a sub model. This object is displayed in Figure 1. The subsystem contains external ports over which pallets are exchanged. In this was these ports are used to interconnect the subsequent assembly stations via conveyor belts (of 0.4 meter length). The assembler within **AssemblyStation** is modeled by an instance of **Delay** from the *Enterprise library*, with parameters for statistical data-collection.

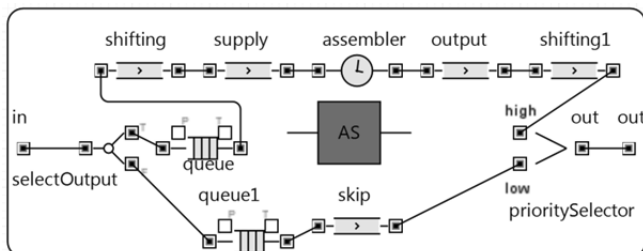

Figure 1. Detailed view of single assembly station, containing belts, shifting, buffers and assembler.

The graphical editor was used to choose, place, arrange and connect the required components from the AnyLogic palette view onto the drawing surface. The object logic is programmed manually in the customization view of the corresponding component using Java language. This logic is stored together with the rest of the model in a XML project file. All of the eight subsystems are linked either directly (A2 and A3 as well as A6 and A1) or by conveyor belts to form the assembly line.

A-Task: Control Strategy - Statistical Evaluation. A local control strategy is used within the components, e.g. for decision whether a pallet is to be shifted and processed. Each pallet object is represented by an instance of the user defined Java class **Pallet**, which extends the predefined class **Entity**. Pallet contains flags representing its processing state and time information, is used for calculations regarding the throughput time.

Collection and analysis of statistical data are dealt with directly in the model. This is supported by the native AnyLogic objects **Dataset** (for internal data storage) and **Chart** (for graphical output) which are instantiated from the *Analysis* palette of components.

For the export of the graphical information, i.e. chart presentations the diagrams have been captured from the on-screen simulator window. On the other hand the textual data stored within the **Dataset** objects can be accessed and exported by using a copy-command.

B-Task: Simulation-Throughput. The plot in Figure 2 shows an overview of the simulation results for simulation runs with a varying number of pallets in the system. The red markers indicate the total throughput of pallets processed during the whole simulation period (blue markers: average throughput time of a pallet in sec.).

A total throughput of 1440 pallets is achieved when there are 16 pallets in the system. This result remains constant for any run with a higher number of pallets. Parallel to this, the average throughput time increases steadily, starting from 20 to 60 pallets (Table 1).

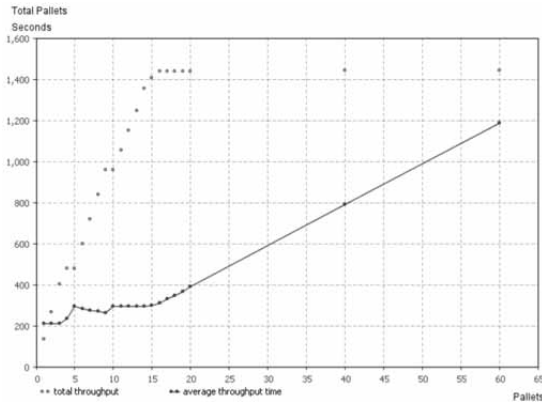

Figure 2. Total pallet throughput (red) and average throughput time of pallet (blue) vs. number of pallets in system.

A validation of the throughput time (for one pallet) can be calculated by hand. It sums up the travelling and processing times. One needs to calculate the travel through internal ($2 \cdot 2m + 3 \cdot 1.6m + 1.6m + 1.6m + 1.6m$) and connecting ($6 \cdot 0.4m$) belts which sums up to $16m$ and divided this by the travel speed of 18 m/min (0.3 m/s) which leads to 53.33 s . The processing time of a pallet consist of shifting ($2 \cdot 5 \cdot 2 \text{ s}$) and processing ($15 \text{ s} + 60 \text{ s} + 20 \text{ s} + 20 \text{ s} + 20 \text{ s}$) actions which sum up to 155 s . Thus a pallet needs at least 208.33 s to travel the system - which correlates with the simulation results (Table 1).

C-Task: Pallet Number Optimisation. A parameter loop (Listing 1) was used in order to find an optimum with regard to maximal throughput and minimal throughput times. The found optimum number for pallets in the system is 16 and leads to a throughput time of 311.76 seconds . This can be taken from Figure 2: The total throughput of pallets remains constant (1440) for 16 and more pallets in the system and a higher number only leads to higher average throughput times. A throughput greater than 1440 pallets cannot be achieved since the system is limited by the processing times of the stations (which – as in Tas B - can be calculated by hand).

As suggested the simulation is run without measurement for a warm-up period (method `warmup()`) of two hours followed by a measuring interval of eight hours. The method `getState()` queries the execution state of the simulator. This is helpful during initial tests of the model so the loop can be exited earlier without having to wait for completion.

Pallets	1-3	4	5	15	20	40	60
TTpt	208	234	294	299	398	791	1194

Table 1. Average throughput time TTp for number of pallets.

```

1. for (int i = 0; i < 20; ++i) {
2.   injectPallet(1);
3.   warmup();
4.   getEngine().getPresentation().refresh();
5.   measure();
6.   if (getState() == FINISHED) {
7.     break;

```

Listing 1. JAVA-fraction of the implemented loop.

Figure 3 presents the utilization-ratio (time occupied over total time) of the assemblers within the assembly stations. The ratio is plotted with respect to the number of pallets within the system (loading times neglected).

From Figure 3 the supportive role of A6 for stations A3-A5 becomes clearly visible (e.g. at 17-19 pallets in system). Further the ratio of A1 remains at 75% from 16 pallets on (explained by processing time of 15 s vs. 20 s for three A2 stations and each of A3-A5) and shows the same qualitative behavior as the total throughput in fig. 2 (as its load stays constant and every pallet has to pass through it).

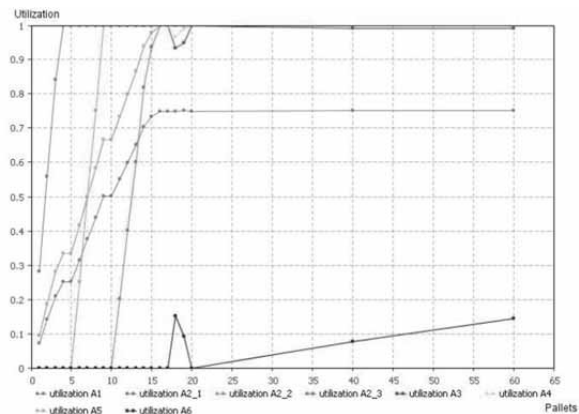

Figure 3. Utilization ratio of assembly stations with respect to pallets in system.

Resume. AnyLogic proved to be a stable and handy simulation environment for the realization of ARGES-IM Benchmark C2. Its main drawbacks lie with the post-processing of simulation results/-data for which workarounds needed to be found. Big advantages of the simulator are definitely the existing libraries in combination with the possibility for the user to add Java code at any given place and thus customize and enhance models, classes or predefined objects, as well as the platform-independence of AnyLogic.

Submitted: March, 2010

Revised: November 5, 2010

Accepted: August 30, 2011

A MATLAB-based Solution to ARGESIM Benchmark C2 'Flexible Assembly System' using SimEvents

Tobias Pingel*, Sven Pawletta

Wismar University of Applied Sciences, Computational Engineering and Automation, Philipp-Mueller-Strasse, 23952 Wismar, Germany; *tobias.pingel@hs-wismar.de

Simulator. SimEvents, part of the MATLAB product family since 2006, extends Simulink by a blockset for general purpose transaction-oriented discrete-event simulation based on entities. With libraries of predefined blocks, such as queues, servers, and switches, SimEvents can be used for simulating manufacturing processes to determine resource requirements, throughputs and to identify potential bottlenecks, for example. Statistical evaluation can be performed during simulation with the use of the block's statistics signal output port and appropriate signal scopes. These signals can e.g. be the number of departed entities or average utilization of a server.

For implementing the desired control strategy, to control the flow of entities, SimEvents offers several possibilities. Here, the blocks' control strategy can be parameterized directly, can be based up on attributes for e.g. the routing path or service time or based on State-flow state charts via the signal input ports if more complex control is desired. The simulation of the entity flow itself is based on an event list. If an entity is advanced from one block to the next, events are generated which cause subsequent entities to be requested, in return.

Modeling. As illustrated in Figure 1, the *C2 Flexible Assembly System* consists of eight nearly identical assembly subsystems (A1-A6) as well as a subsystem for entity generation. These subsystems are connected together for realizing the material flow. The pallets are represented by entities.

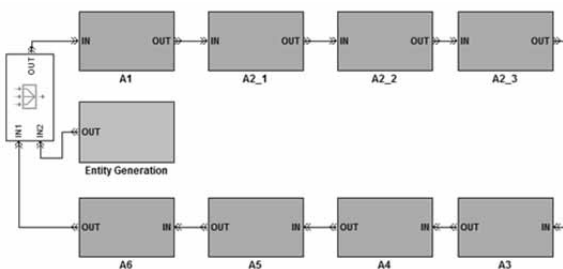

Figure 1. Flexible Assembly System.

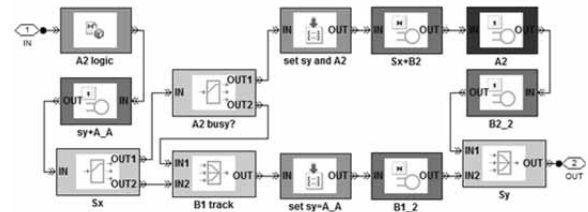

Figure 2. A2_1 Assembly Subsystem

Each subsystem (see Figure 2) is modelled by using standard blocks of the SimEvents library. The conveyor belts, the assembly station as well as the shifting process are represented by a *Single Server* or *N-Server* with appropriate service times. For entity routing *Output Switches* and *Path Combiners* are used. Attribute manipulators (*Set Attribute* and *User-defined Attribute Function*) are used for implementing the desired control behaviour.

By entering the subsystem the *A2 logic* block determines – based on the *ServiceCompletion*-flag – whether the pallet is routed to B1 or B2 (Listing 1).

The pallet then passes the conveyor belt *A_A*, where the service time – in the attribute *sy* – with a value of either $t_{transport} + t_{shift}$ or just $t_{transport}$ depending of whether the pallet need to be shifted back to the main track in the previous assembly subsystem. This design is required since *Sy* has no storage capacity.

Attribute	Purpose
A1 ... A5	ServiceCompletion-flag
p	Path for pallet at <i>Sx</i> (<i>B1</i> or <i>B2</i>)
sy	Transportation time at <i>Sy</i>
rt	Read timer (only <i>A1</i>)
T1	Time stamp (used by <i>Timer</i> blocks)

Table 1. Entity attributes.

```
function out_p = fcn(A1, A2, A3, A4, A5)
out_p = 2;
if A1 && ~A2 && ((~A3&&~A4&&~A5) || (A3&&A4&&A5)),
    out_p = 1; end
```

Listing 1. A2 logic (User-defined Matlab Function)

In the next step, the pallet is routed based on p to $B1$ or $B2$ at Sx . If the $B2$ conveyor belt is busy the pallet is routed back to $B1$. The routing strategy of $A2$ *busy?* is set to 'First port that is not blocked'. On the $B2$ track the entity attributes $A2$ and sy are modified, where on the $B1$ track sy is just set to $t_{transport}$ with a service time of 4/3 seconds (0.4m / 0.3m/s).

For realizing prioritization at Sy the control strategy is set to 'IN1 port precedence' and a higher *Service completion event priority* is defined for $B2_2$ than for $B1_2$ to guarantee accurate processing in the case of simultaneous event occurrence.

A-Task: Control Strategy and Evaluation. The control strategy is implemented by using entity attributes, user-defined code as well as predefined block strategies. The attributes are modified by manipulator blocks while traversing through the whole assembly system and are routed and delayed based up on these.

As illustrated in Figure 3, time measurement and counting of finished workpieces are realized using *Timer* blocks within the $A1$ subsystem. Here, based on the attribute rt the pallet is routed to the *Start Timer* block first, equipped with a time stamp attribute $T1$ and then evaluated by the *Read Timer* block, if the workpiece is unloaded. By again passing the *Start Timer* block $T1$ is being reset.

The recorded data is displayed using Signal Scope blocks and sent to the MATLAB workspace using appropriate blocks for data preparation.

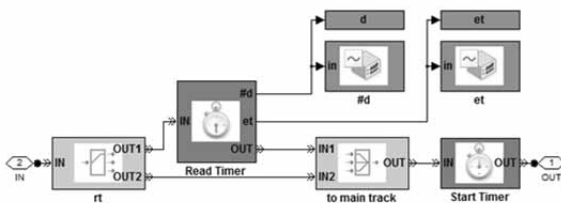

Figure 3. Time measurement and workpiece counting.

B-Task: Simulation-Throughput. The simulation study had been performed using a MATLAB script as sketched in Listing 2. Here, ten to just 49 pallets were used, since a deadlock occurred by using 50 or more entities. Then, the relevant data from the 120th to the 600th minute (eight hours shift excluding the warm-up period) was extracted from the recorded signals d and et . Based on this data the total throughput as well as the average throughput time per simulation could be computed (Listing 2). The results of the simulation study using 10 to 49 pallets are listed in Table 2.

```
for np = 10:49,
    sim('C2_FAS.mdl', 36000); k = np-10+1;
    [tp(k) at(k)] = evaluate_sim(d, et);
end
```

Listing 2: Simulation study with 10 to 49 pallet.

Number of pallets (np)	Total throughput (tp)	Avg. throughput time in sec. (at)
10	959	285
11	1072	280
12	1185	276
13	1298	273
14	1439	265
15	1439	285
20	1439	385
25	1439	396
30	1440	586
35	1438	682
40	1437	787
45	1440	882
50...60	(deadlock)	(deadlock)

Table 2. Simulation results.

C-Task C: Pallet Number Optimisation. For automatical optimization a user-defined parameter optimization function (Listing 3) had been implemented in MATLAB. Therefore, an objective function $|tp - at| \cdot tp$ with respects to minimum average throughput time and overall throughput was used. The optimum is 14 pallets, yielding into a throughput of 1439 and an average throughput time of 265 seconds.

```
[opt idx] = min(abs(tp-at).*tp);
tp_opt = tp(idx); at_opt = at(idx);
np_opt = idx-1+10;
```

Listing 3: Simulation study with 10 to 49 pallets.

Resume. SimEvents – as a simulation tool for general purpose discrete-event simulation – is well-suited for simulating manufacturing systems. The model can be build up individually and at any level of detail using a variety of simple standard blocks. With predefined strategies the process flow can be controlled locally. If more complex control is required, SimEvents can be extended by Stateflow using state charts.

Submitted: September 2010

Accepted: June 30, 2011

SNE Simulation News

EUROSIM Data and Quick Info



EUROSIM 2013

8th EUROSIM Congress on Modelling and Simulation

The City Hall, Cardiff, Wales, United Kingdom 10-13 September 2013

www.eurosim2013.info

Contents

Info EUROSIM	2
Info EUROSIM Societies	3 - 6
Info ASIM, CROSSIM	3
Info CSSS, HSS, DBSS, FRANCOSIM	4
Info ISCS, PSCS, SIMS, SLOSIM	5
Info UKSIM, LSS, CAE-SMSG, ROMSIM	6
Reports EUROSIM, ASIM.....	7-8

Simulation Notes Europe SNE is the official membership journal of EUROSIM and distributed / available to members of the EUROSIM Societies as part of the membership benefits. SNE is published in a printed version (Print ISSN 2305-9974) and in an online version (Online ISSN 2306-0271). With Online SNE the publisher ARGESIM follows the Open Access strategy for basic SNE contributions. Since 2011 Online SNE contributions are identified by DOI 10.11128/sne.xx.nnnnn. for better web availability and indexing.

Print SNE, high-resolution Online SNE, and additional SNE contributions are available for subscription via membership in a EUROSIM society.

This *EUROSIM Data & Quick Info* compiles data from EUROSIM societies and groups: addresses, weblinks, officers of societies with function and email, to be published regularly in SNE issues.

SNE Reports Editorial Board

EUROSIM Khalid Al-Begain, kbegain@glam.ac.uk
Borut Zupančič, borut.zupancic@fe.uni-lj.si
Felix Breitenecker, Felix.Breitenecker@tuwien.ac.at
ASIM Thorsten Pawletta, pawel@mb.hs-wismar.de
CROSSIM Vesna Dušak, vdusak@foi.hr
CSSS Mikuláš Alexík, alexik@frtk.utc.sk
DBSS A. Heemink, a.w.heemink@its.tudelft.nl
FRANCOSIM Karim Djouani, djouani@u-pec.fr
HSS András Jávör, javor@eik.bme.hu
ISCS M. Savastano, mario.savastano@unina.it
PSCS Zenon Sosnowski, zenon@ii.pb.bialystok.pl
SIMS Esko Juuso, esko.juuso@oulu.fi
SLOSIM Rihard Karba, rihard.karba@fe.uni-lj.si
UKSIM Richard Zobel, r.zobel@ntlworld.com
CAE-SMSG Emilio Jiminez, emilio.jiminez@unirioja.es
LSS Yuri Merkuryev, merkur@itl.rtu.lv
ROMSIM Florin Stanculescu, sflorin@ici.ro

SNE Editorial Office /ARGESIM

→ www.sne-journal.org, www.eurosim.info

✉ office@sne-journal.org

Felix Breitenecker, eic@sne-journal.org

Anna Mathe, Anna.Mathe@tuwien.ac.at, office@sne-journal.org

Nikolas Popper, Niki.Popper@drahtwarenhandlung.at

If you have any information, announcement, etc. you want to see published, please contact a member of the editorial board in your society or the editorial office.



EUROSIM
Federation of European Simulation
Societies

General Information. EUROSIM, the Federation of European Simulation Societies, was set up in 1989. The purpose of EUROSIM is to provide a European forum for regional and national simulation societies to promote the advancement of modelling and simulation in industry, research, and development.

→ www.eurosim.info

Member Societies. EUROSIM members may be national simulation societies and regional or international societies and groups dealing with modelling and simulation. At present EUROSIM has thirteen full members and one observer member:

ASIM	Arbeitsgemeinschaft Simulation <i>Austria, Germany, Switzerland</i>
CEA-SMSG	Spanish Modelling and Simulation Group <i>Spain</i>
CROSSIM	Croatian Society for Simulation Modeling <i>Croatia</i>
CSSS	Czech and Slovak Simulation Society <i>Czech Republic, Slovak Republic</i>
DBSS	Dutch Benelux Simulation Society <i>Belgium, Netherlands</i>
FRANCOSIM	Société Francophone de Simulation <i>Belgium, France</i>
HSS	Hungarian Simulation Society <i>Hungary</i>
ISCS	Italian Society for Computer Simulation <i>Italy</i>
LSS	Latvian Simulation Society <i>Latvia</i>
PSCS	Polish Society for Computer Simulation <i>Poland</i>
SIMS	Simulation Society of Scandinavia <i>Denmark, Finland, Norway, Sweden</i>
SLOSIM	Slovenian Simulation Society <i>Slovenia</i>
UKSIM	United Kingdom Simulation Society <i>UK, Ireland</i>
ROMSIM	Romanian Society for Modelling and Simulation, <i>Romania, Observer Member</i>

Contact addresses, weblinks and officers of the societies may be found in the information part of the societies.

EUROSIM Board/EUROSIM Officers. EUROSIM is governed by a board consisting of one representative of each member society, president and past president, and representatives for SNE and SIMPRA. The President is nominated by the society organising the next EUROSIM Congress. Secretary and Treasurer are elected out of members of the Board.

President	Khalid Al.Begain <i>kbegain@glam.ac.uk</i>
Past president	Mikuláš Alexík (CSSS), <i>alexik@frtk.fri.utc.sk</i>
Secretary	Borut Zupančič (SLOSIM) <i>borut.zupancic@fe.uni-lj.si</i>
Treasurer	Felix Breitenecker (ASIM) <i>felix.breitenecker@tuwien.ac.at</i>
SNE Repres.	Felix Breitenecker <i>felix.breitenecker@tuwien.ac.at</i>

SNE – Simulation Notes Europe. SNE is a scientific journal with reviewed contributions as well as a membership newsletter for EUROSIM with information from the societies in the *News Section*. EUROSIM societies are offered to distribute to their members the journal SNE as official membership journal. SNE Publishers are EUROSIM, ARGESIM and ASIM.

Editor-in-chief	Felix Breitenecker <i>felix.breitenecker@tuwien.ac.at</i>
-----------------	--

→ www.sne-journal.org, *menu SNE*

✉ office@sne-journal.org

EuroSim Congress. EUROSIM is running the triennial conference series EUROSIM Congress. The congress is organised by one of the EUROSIM societies. EUROSIM 2013 will be organised by UKSIM in Cardiff, Wales, UK, September 10-13, 2013.

Chairs / Team EUROSIM 2010

Khalid Al.Begain, <i>kbegain@glam.ac.uk</i>
Richard Zobel, <i>r.zobel@ntlworld.com</i>
David Al-Dabass, <i>david.al-dabass@ntu.ac.uk</i>
Alessandra Orsoni, <i>A.Orsoni@kingston.ac.uk</i>
Richard Cant, <i>richard.cant@ntu.ac.uk</i>

→ www.eurosim2013.com



ASIM German Simulation Society Arbeitsgemeinschaft Simulation

ASIM (Arbeitsgemeinschaft Simulation) is the association for simulation in the German speaking area, servicing mainly Germany, Switzerland and Austria. ASIM was founded in 1981 and has now about 700 individual members, and 30 institutional or industrial members. Furthermore, ASIM counts about 300 affiliated members.

→ www.asim-gi.org with members' area

✉ info@asim-gi.org, admin@asim-gi.org

✉ ASIM – Inst. f. Analysis and Scientific Computing
Vienna University of Technology
Wiedner Hauptstraße 8-10, 1040 Vienna, Austria

ASIM Officers

President	Felix Breitenecker felix.breitenecker@tuwien.ac.at
Vice presidents	Sigrid Wenzel, s.wenzel@uni-kassel.de T. Pawletta, pawel@mb.hs-wismar.de
Secretary	Anna Mathe, anna.mathe@tuwien.ac.at
Treasurer	I. Bausch-Gall, Ingrid@Bausch-Gall.de
Membership affairs	S. Wenzel, s.wenzel@uni-kassel.de W. Maurer, werner.maurer@zhwin.ch I. Bausch-Gall, Ingrid@Bausch-Gall.de F. Breitenecker, felix.breitenecker@tuwien.ac.at
Universities / Research Inst.	S. Wenzel, s.wenzel@uni-kassel.de W. Wiechert, W.Wiechert@fz-juelich.de J. Haase, Joachim.Haase@eas.iis.fraunhofer.de Katharina Nöh, k.noeh@fz-juelich.de
Industry	S. Wenzel, s.wenzel@uni-kassel.de K. Panreck, Klaus.Panreck@hella.com
Conferences	Klaus Panreck Klaus.Panreck@hella.com A. Gnauck, albrecht.gnauck@tu-cottbus.de
Publications	Th. Pawletta, pawel@mb.hs-wismar.de Christina Deatcu, christina.deatcu@hs-wismar.de F. Breitenecker, felix.breitenecker@tuwien.ac.at
Repr. EUROSIM	F. Breitenecker, felix.breitenecker@tuwien.ac.at N. Popper, niki.popper@drahtwarenhandlung.at
Education / Teaching	Ch. Deatcu, christina.deatcu@hs-wismar.de N. Popper, niki.popper@drahtwarenhandlung.at Katharina Nöh, k.noeh@fz-juelich.de
International Affairs	H. Szczerbicka, hsz@sim.uni-hannover.de O. Rose, Oliver.Rose@tu-dresden.de
Editorial Board SNE	T. Pawletta, pawel@mb.hs-wismar.de Ch. Deatcu, christina.deatcu@hs-wismar.de
Web EUROSIM	Anna Mathe, anna.mathe@tuwien.ac.at

Last data update March 2011

ASIM Working Groups. ASIM, part of GI - Gesellschaft für Informatik, is organised in Working Groups, dealing with applications and comprehensive subjects:

ASIM Working Groups

GMMS	Methods in Modelling and Simulation Th. Pawletta, pawel@mb.hs-wismar.de
SUG	Simulation in Environmental Systems J. Wittmann, wittmann@informatik.uni-hamburg.de
STS	Simulation of Technical Systems H.T.Mammen, Heinz-Theo.Mammen@hella.com
SPL	Simulation in Production and Logistics Sigrid Wenzel, s.wenzel@uni-kassel.de
EDU	Simulation in Education/Education in Simulation N. Popper, niki.popper@drahtwarenhandlung.at
SBW SVS STA	Special Working Groups on Simulation in OR , Traffic Systems, Standardisation, Modelica, Numerical Mathematics, etc.

Last data update December 2011

CROSSIM – Croatian Society for Simulation Modelling

CROSSIM-Croatian Society for Simulation Modelling was founded in 1992 as a non-profit society with the goal to promote knowledge and use of simulation methods and techniques and development of education. CROSSIM is a full member of EUROSIM since 1997.

→ www.eurosim.info

✉ vdusak@foi.hr

✉ CROSSIM / Vesna Dušak
Faculty of Organization and
Informatics Varaždin, University of Zagreb
Pavlinska 2, HR-42000 Varaždin, Croatia

CROSSIM Officers

President	Jadranka Božikov, jbozikov@snz.hr
Vice president	Vesna Dušak, vdusak@foi.hr
Secretary	Vesna Bosilj-Vukšić, vbosilj@efzg.hr
Executive board members	Vlatko Čerić, vceric@efzg.hr Tarzan Legović, legovic@irb.hr
Repr. EUROSIM	Jadranka Božikov, jbozikov@snz.hr
Edit. Board SNE	Vesna Dušak, vdusak@foi.hr
Web EUROSIM	Jadranka Božikov, jbozikov@snz.hr

Last data update March 2011



CSSS – Czech and Slovak Simulation Society

CSSS -The *Czech and Slovak Simulation Society* has about 150 members working in Czech and Slovak national scientific and technical societies (*Czech Society for Applied Cybernetics and Informatics, Slovak Society for Applied Cybernetics and Informatics*). The main objectives of the society are: development of education and training in the field of modelling and simulation, organising professional workshops and conferences, disseminating information about modelling and simulation activities in Europe. Since 1992, CSSS is full member of EUROSIM.

→ www.fit.vutbr.cz/CSSS

✉ snorek@fel.cvut.cz

✉ CSSS / Miroslav Šnorek, CTU Prague
FEE, Dept. Computer Science and Engineering,
Karlovo nám. 13, 121 35 Praha 2, Czech Republic

CSSS Officers

President	Miroslav Šnorek, snorek@fel.cvut.cz
Vice president	Mikuláš Alexík, alexik@frtk.fri.utc.sk
Treasurer	Evžen Kindler, ekindler@centrum.cz
Scientific Secr.	A. Kavička, Antonin.Kavicka@upce.cz
Repr. EUROSIM	Miroslav Šnorek, snorek@fel.cvut.cz
Deputy	Mikuláš Alexík, alexik@frtk.fri.utc.sk
Edit. Board SNE	Mikuláš Alexík, alexik@frtk.fri.utc.sk
Web EUROSIM	Petr Peringer, peringer@fit.vutbr.cz

Last data update December 2009

FRANCOSIM – Société Francophone de Simulation

FRANCOSIM was founded in 1991 and aims to the promotion of simulation and research, in industry and academic fields. Francosim operates two poles.

- Pole Modelling and simulation of discrete event systems. Pole Contact: *Henri Pierreal, pierre-va@imfa.fr*
- Pole Modelling and simulation of continuous systems. Pole Contact: *Yskandar Hamam, y.hamam@esiee.fr*

→ www.eurosim.info

✉ y.hamam@esiee.fr

✉ FRANCOSIM / Yskandar Hamam
Groupe ESIEE, Cité Descartes,
BP 99, 2 Bd. Blaise Pascal,
93162 Noisy le Grand CEDEX, France

FRANCOSIM Officers

President	Yskandar Hamam, y.hamam@esiee.fr
Treasurer	François Rocaries, f.rocaries@esiee.fr
Repr. EUROSIM	Yskandar Hamam, y.hamam@esiee.fr
Edit. Board SNE	Yskandar Hamam, y.hamam@esiee.fr

Last data update April 2006

DBSS – Dutch Benelux Simulation Society

The Dutch Benelux Simulation Society (DBSS) was founded in July 1986 in order to create an organisation of simulation professionals within the Dutch language area. DBSS has actively promoted creation of similar organisations in other language areas. DBSS is a member of EUROSIM and works in close cooperation with its members and with affiliated societies.

→ www.eurosim.info

✉ a.w.heemink@its.tudelft.nl

✉ DBSS / A. W. Heemink
Delft University of Technology, ITS - twi,
Mekelweg 4, 2628 CD Delft, The Netherlands

DBSS Officers

President	A. Heemink, a.w.heemink@its.tudelft.nl
Vice president	W. Smit, smitnet@wxs.nl
Treasurer	W. Smit, smitnet@wxs.nl
Secretary	W. Smit, smitnet@wxs.nl
Repr. EUROSIM	A. Heemink, a.w.heemink@its.tudelft.nl
Deputy	W. Smit, smitnet@wxs.nl
Edit. Board SNE	A. Heemink, a.w.heemink@its.tudelft.nl

Last data update April 2006

HSS – Hungarian Simulation Society

The Hungarian Member Society of EUROSIM was established in 1981 as an association promoting the exchange of information within the community of people involved in research, development, application and education of simulation in Hungary and also contributing to the enhancement of exchanging information between the Hungarian simulation community and the simulation communities abroad. HSS deals with the organization of lectures, exhibitions, demonstrations, and conferences.

→ www.eurosim.info

✉ javor@eik.bme.hu

✉ HSS / András Jávör,
Budapest Univ. of Technology and Economics,
Sztoczek u. 4, 1111 Budapest, Hungary

**HSS Officers**

President	András Jávör, javor@eik.bme.hu
Vice president	Gábor Szűcs, szucs@itm.bme.hu
Secretary	Ágnes Vigh, vigh@itm.bme.hu
Repr. EUROSIM	András Jávör, javor@eik.bme.hu
Deputy	Gábor Szűcs, szucs@itm.bme.hu
Edit. Board SNE	András Jávör, javor@eik.bme.hu
Web EUROSIM	Gábor Szűcs, szucs@itm.bme.hu

Last data update March 2008

PSCS – Polish Society for Computer Simulation - update

PSCS was founded in 1993 in Warsaw. PSCS is a scientific, non-profit association of members from universities, research institutes and industry in Poland with common interests in variety of methods of computer simulations and its applications. At present PSCS counts 257 members.

→ www.ptsk.man.bialystok.pl✉ leon@ibib.waw.pl✉ PSCS / Leon Bobrowski, c/o IBIB PAN,
ul. Trojdena 4 (p.416), 02-109 Warszawa, Poland**PSCS Officers**

President	Leon Bobrowski, leon@ibib.waw.pl
Vice president	Andrzej Grzyb, Tadeusz Nowicki
Treasurer	Z. Sosnowski, zenon@ii.pb.bialystok.pl
Secretary	Zdzisław Galkowski, Zdzislaw.Galkowski@simr.pw.edu.pl
Repr. EUROSIM	Leon Bobrowski, leon@ibib.waw.pl
Deputy	A.Chudzikiewicz, ach@it.pw.edu.pl
Edit. Board SNE	Z.Sosnowski, zenon@ii.pb.bialystok.pl
PSCS Board Members	R. Bogacz, Z. Strzyzakowski Andrzej Tylikowski

Last data update March 2009

ISCS – Italian Society for Computer Simulation

The Italian Society for Computer Simulation (ISCS) is a scientific non-profit association of members from industry, university, education and several public and research institutions with common interest in all fields of computer simulation.

→ www.eurosim.info✉ Mario.savastano@uniina.it✉ ISCS / Mario Savastano,
c/o CNR - IRSIP,
Via Claudio 21, 80125 Napoli, Italy**ISCS Officers**

President	M. Savastano, mario.savastano@uniina.it
Vice president	F. Maceri, Franco.Maceri@uniroma2.it
Repr. EUROSIM	F. Maceri, Franco.Maceri@uniroma2.it
Edit. Board SNE	M. Savastano, mario.savastano@uniina.it

Last data update April 2005

SIMS – Scandinavian Simulation Society

SIMS is the *Scandinavian Simulation Society* with members from the four Nordic countries Denmark, Finland, Norway and Sweden. The SIMS history goes back to 1959. SIMS practical matters are taken care of by the SIMS board consisting of two representatives from each Nordic country. Iceland will be represented by one board member.

SIMS Structure. SIMS is organised as federation of regional societies. There are FinSim (Finnish Simulation Forum), DKSIM (Dansk Simuleringsforening) and NFA (Norsk Forening for Automatisering).

→ www.scansims.org✉ esko.juuso@oulu.fi

✉ SIMS / SIMS/Esko Juuso, Department of Process and Environmental Engineering, 90014 Univ.Oulu, Finland

SIMS Officers

President	Esko Juuso, esko.juuso@oulu.fi
Treasurer	Vadim Engelson, vadim.engelson@mathcore.com
Repr. EUROSIM	Esko Juuso, esko.juuso@oulu.fi
Edit. Board SNE	Esko Juuso, esko.juuso@oulu.fi
Web EUROSIM	Vadim Engelson

Last data update December March 2011

SLOSIM – Slovenian Society for Simulation and Modelling

SLOSIM - Slovenian Society for Simulation and Modelling was established in 1994 and became the full member of EUROSIM in 1996. Currently it has 69



members from both slovenian universities, institutes, and industry. It promotes modelling and simulation approaches to problem solving in industrial as well as in academic environments by establishing communication and cooperation among corresponding teams.

→ www.slosim.si✉ slosim@fe.uni-lj.si✉ SLOSIM / Rihard Karba, Faculty of Electrical Engineering, University of Ljubljana,
Tržaška 25, 1000 Ljubljana, Slovenia



SLOSIM Officers

President	B. Zupančič, borut.zupancic@fe.uni-lj.si
Vice president	Leon Žlajpah, leon.zlajpah@ijs.si
Secretary	Vito Logar, vito.logar@fe.uni-lj.si
Treasurer	Milan Simčič, milan.simcic@fe.uni-lj.si
Repr. EUROSIM	B. Zupančič, borut.zupancic@fe.uni-lj.si
Deputy	Rihard Karba, rihard.karba@fe.uni-lj.si
Edit. Board SNE	Rihard Karba, rihard.karba@fe.uni-lj.si
Web EUROSIM	Vito Logar, vito.logar@fe.uni-lj.si

Last data update March 2011

UKSIM – United Kingdom Simulation Society

UKSIM has more than 100 members throughout the UK from universities and industry. It is active in all areas of simulation and it holds a biennial conference as well as regular meetings and workshops.

→ www.uksim.org.uk

✉ david.al-dabass@ntu.ac.uk

- ✉ UKSIM / Prof. David Al-Dabass
Computing & Informatics,
Nottingham Trent University
Clifton lane, Nottingham, NG11 8NS
United Kingdom

UKSIM Officers

President	David Al-Dabass, david.al-dabass@ntu.ac.uk
Secretary	A. Orsoni, A.Orsoni@kingston.ac.uk
Treasurer	B. Thompson, barry@bjtcon.ndo.co.uk
Membership chair	K. Al-Begain, kbegain@glam.ac.uk
Univ. liaison chair	R. Cheng, rchc@maths.soton.ac.uk
Repr. EUROSIM	Richard Zobel, r.zobel@ntlworld.com
Edit. Board SNE	Richard Zobel, r.zobel@ntlworld.com

Last data update March 2009 (partially)

CEA-SMSG – Spanish Modelling and Simulation Group

CEA is the Spanish Society on Automation and Control. In order to improve the efficiency and to deep into the different fields of automation, the association is divided into thematic groups, one of them is named 'Modelling and Simulation', constituting the group.

→ www.cea-ifac.es/wwwgrupos/simulacion

→ simulacion@cea-ifac.es

- ✉ CEA-SMSG / María Jesús de la Fuente,
System Engineering and Automatic Control department,
University of Valladolid,
Real de Burgos s/n., 47011 Valladolid, SPAIN

CAE - SMSG Officers

President	María J. la Fuente, maria@autom.uva.es
Repr. EUROSIM	Emilio Jimenez, emilio.jimenez@unirioja.es
Edit. Board SNE	Emilio Jimenez, emilio.jimenez@unirioja.es

Last data update March 2009

LSS – Latvian Simulation Society

The Latvian Simulation Society (LSS) has been founded in 1990 as the first professional simulation organisation in the field of Modelling and simulation in the post-Soviet area. Its members represent the main simulation centres in Latvia, including both academic and industrial sectors.

→ briedis.itl.rtu.lv/imb/

✉ merkur@itl.rtu.lv

- ✉ LSS / Yuri Merkuryev, Dept. of Modelling and Simulation Riga Technical University
Kalku street 1, Riga, LV-1658, LATVIA

LSS Officers

President	Yuri Merkuryev, merkur@itl.rtu.lv
Repr. EUROSIM	Yuri Merkuryev, merkur@itl.rtu.lv
Edit. Board SNE	Yuri Merkuryev, merkur@itl.rtu.lv

Last data update December 2008

ROMSIM – Romanian Modelling and Simulation Society

ROMSIM has been founded in 1990 as a non-profit society, devoted to both theoretical and applied aspects of modelling and simulation of systems. ROMSIM currently has about 100 members from both Romania and Republic of Moldavia.

→ www.ici.ro/romsim/

✉ sflorin@ici.ro

- ✉ ROMSIM / Florin Stanculescu,
National Institute for Research in Informatics, Averișcu
Av. 8 – 10, 71316 Bucharest, Romania

ROMSIM Officers

President	Florin Stanculescu, sflorin@ici.ro
Vice president	Florin Hartescu, flory@ici.ro Marius Radulescu, mradulescu@ici.ro
Secretary	Zoe Radulescu, radulescu@ici.ro
Repr. EUROSIM	Florin Stanculescu, sflorin@ici.ro
Deputy	Florin Hartescu, flory@ici.ro
Edit. Board SNE	Florin Stanculescu, sflorin@ici.ro

Last data update March 2009

EUROSIM Federation of European Simulation Societies

On occasion of the EUROSIM Board Meeting at University Cambridge, during UK SIM Conference in March 2011, some important topics were discussed and decisions for the future were taken.



Participants at Cambridge Board Meeting 2011:

R. Zobel, Y. Merkuryew, M. Alexik, E. Juuso, A. Mathe,
K. Al Begain, M. Snorek, F. Breitenecker,
B. Zupancic, E. Jiminez

EUROSIM Membership

The board underlined, that EUROSIM is open to any simulation society and simulation group in Europe, which is active in modelling and simulation. Requirements are support of and activities in modelling and simulation, and some requirements on formal registration, on size, and on proven conference organisation. It is expected, that in future some countries will have more members in Eurosim, and that also international working groups will join EUROSIM.

SNE Publication

The board unanimously agreed on the new publication strategy and distribution strategy of SNE – now **Simulation Notes Europe**. SNE is the official membership journal of EUROSIM and distributed / available to members of the EUROSIM Societies as part of the membership benefits. SNE is published in a printed version (Print ISSN 2305-9974) and in an online version (Online ISSN 2306-0271).

With Online SNE the publishers follow the **Open Access** strategy for basic SNE contributions, a demand from a majority of EUROSIM member societies. **Online SNE** in high-resolution quality with colour pages, additional SNE contributions as benchmark sources, and the

SNE Archive are implemented for EUROSIM member societies as additional part of their society subscription and are accessible via web for members of the EUROSIM member societies.

In order to guarantee a solid basis for SNE publication, the society subscription is obligatory from begin of 2011 on. The subscription fee is depending on the number of members; negotiations in special occasions are foreseen. SNE is strengthening the publication quality by DOI classification (preparation contribution indexing)

EUROSIM Congress 2013 Cardiff

Preparations for this congress have already started. EUROSIM Congress 2013 that will take place in Cardiff City Hall, the webpage is already online for further info: www.eurosim2013.info. The proceedings of the Congress will be published by IEEE CPS and IEEE Explore.

EUROSIM 2013

8th EUROSIM Congress on Modelling and Simulation

September 10 - 13, 2013, Cardiff, UK

www.eurosim2013.info

The EUROSIM 2013 Congress will include invited talks, parallel, special and the poster sessions. Proposals are welcome for Keynotes, Tutorials, and Special Sessions!

IMPORTANT DATES

Paper Submission 10 May 2013

Notifications 15 June 2013

Camera Ready 1 July 2013

Author Registration 1 July 2013

TRACKS. The following tracks are planned:

Neural Networks, Fuzzy Systems, Evolutionary Computation, Autonomous Mental Development, Adaptive Dynamic Programming and Reinforcement Learning, Bioinformatics and Bioengineering, Computational Finance and Economics, Data and Semantic Mining, Games, VR and Visualization, Emergent Technologies, Intelligent Systems and Applications, Hybrid and Soft Computing, Systems Intelligence and Intelligence Systems, Control of Intelligent Systems and Control Intelligence, e-Science and e-Systems, Robotics, Cybernetics, Engineering, Manufacturing and Control, Methodologies, Tools and Operations Research, Discrete Event and Real Time Systems, Image, Speech and Signal Processing, Industry, Business, Management, Human Factors and Social Issues, Energy, Power, Transport, Logistics,



Harbour, Shipping and Marine Simulation, Parallel, Distributed and Software Architectures and Systems, Internet Modelling, Semantic Web and Ontologies, Mobile/Ad hoc Wireless Networks, Mobicast, Sensor Placement, Target Tracking, Performance Engineering of Computer & Communication Systems, Circuits, Sensors and Devices, Computer Art, Posters,

EUROSIM 2013 VENUE

The Congress will be held in the historic and magnificent City Hall in the heart of Cardiff, the capital city of Wales, the Gala Dinner will be held in the main hall of the National Museum of Wales. Social activities include visits to Cardiff Castle and Caerphilly Castle



ASIM German Simulation Society Arbeitsgemeinschaft Simulation

Coming Events.

As in December 2012 the well-known WINTERSIM conference is organised for the first time in Europe (Berlin), ASIM has postponed the autumn 2012 conference ASIM SPL *Simulation in Production and Logistics* to autumn 2013 (**ASIM SPL 2013**). ASIM members are organising contributions and special sessions for WINTERSIM 2012, Berlin.

WINTERSIM 2012

Winter Simulation Conference

December 9-12, 2012, Berlin, Germany

www.wintersim.org

ASIM Publications. ASIM welcomes the new open access publication strategy of SNE and is discussing a similar open access strategy for publications within ASIM. On occasion of the ASIM general assembly at *Symposium Simulation Technique*, Winterthur, September 2011, the members present voted strongly for open access publication at ASIM workshops and conferences. The ASIM Board will develop some possibilities, keeping the benefits for a registered membership.

ASIM Structure. ASIM is structured into Working Groups. In 2011 this working group structure was changed, in order to keep a sound balance of members in the groups, and in order to activate areas. The following table reflects the new structure:

ASIM Working Groups

GMMS	Methods in Modelling and Simulation Th. Pawletta, pawel@mb.hs-wismar.de
SUG	Simulation in Environmental Systems J. Wittmann, J.Wittmann@informatik.uni-hamburg.de
STS	Simulation of Technical Systems H.T.Mammen, Heinz-Theo.Mammen@hella.com
SPL	Simulation in Production and Logistics Sigrid Wenzel, s.wenzel@uni-kassel.de
EDU	Simulation in Education/Education in Simulation N. Popper, niki.popper@drahtwarenhandlung.at
SBW SVS STA MOD	Special Working Groups: Simulation in OR , Traffic Systems, Standardisation, Modelica, Numerical Mathematics, etc.

The working groups SBW *Simulation in OR* and SVS *Simulation of Traffic Systems* have found a new organisational structure as (smaller) special working groups within working groups SPL and GMMS, co-operating there with other special groups as *Standardisation*, *Modelica*, *Numerics*, etc. On the other side, the special group on *Education* is planned to become a working group (with working group status with GI – Gesellschaft für Informatik).



Participants of the ASIM Board Meeting at ASIM Symposium Simulation Technique, Winterthur, Sept. 2011:

T. Pawletta, H.-T. Mammen, W. Maurer, O. Rose,
F. Breitenecker, M. Striebel, C. Deatcu, W. Gnauck,
F. E. Cellier, H. Szerbicka

(visiting excavations of Roman streets below
conference dinner site)

New challenges in modeling and simulation require powerful tools

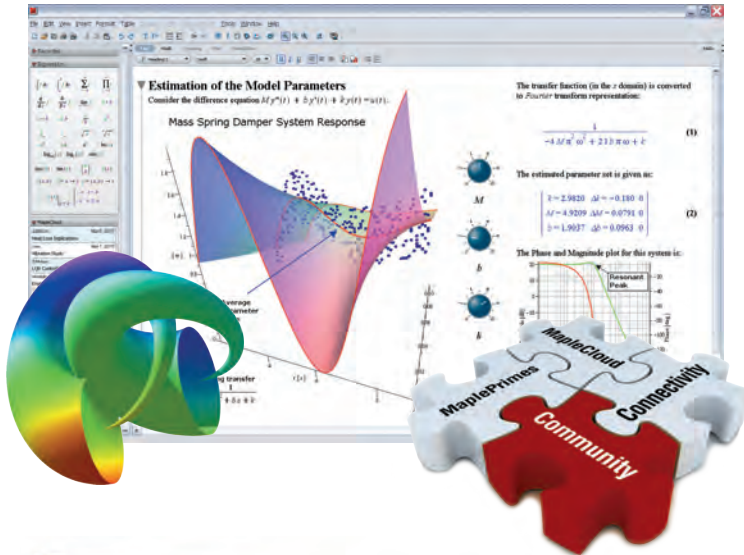

Maple™ 15

The result of over 30 years of cutting-edge research and development, Maple combines the world's most powerful mathematical computation engine with an intuitive, "clickable" user interface.





MapleSim™ 5

MapleSim is a physical modeling and simulation tool built on a foundation of symbolic computation technology.

Get a Price Quote:
www.maplesoft.com/sne

Contact us:

  +49 (0)241/980919-30





*515.000.000 KM, 380.000 SIMULATIONEN
UND KEIN EINZIGER TESTFLUG.*

DAS IST MODEL-BASED DESIGN.

Nachdem der Endabstieg der beiden Mars Rover unter Tausenden von atmosphärischen Bedingungen simuliert wurde, entwickelte und testete das Ingenieur-Team ein ausfallsicheres Bremsraketen-System, um eine zuverlässige Landung zu garantieren. Das Resultat – zwei erfolgreiche autonome Landungen, die exakt gemäß der Simulation erfolgten. Mehr hierzu erfahren Sie unter: www.mathworks.de/mbd

**MATLAB[®]
& SIMULINK[®]**